

Uponor Fluvia Move Pumpgroup PUSH-23-A-AC

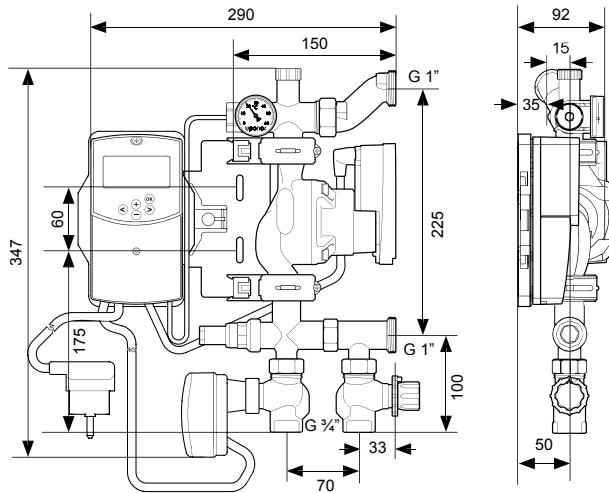

$Q_{max} = 7 \text{ kW}$



$\theta_{sec} = 15-55 \text{ }^\circ\text{C}$



$kvs = 1,2 \text{ m}^3/\text{h}$



$P_{max} = 6 \text{ bar}$

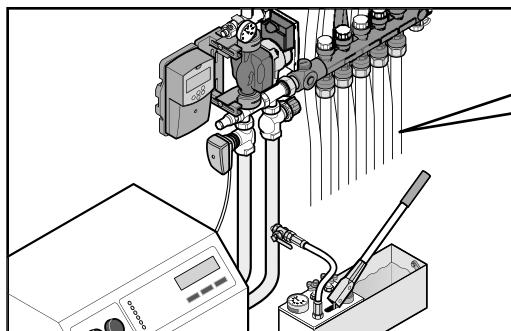
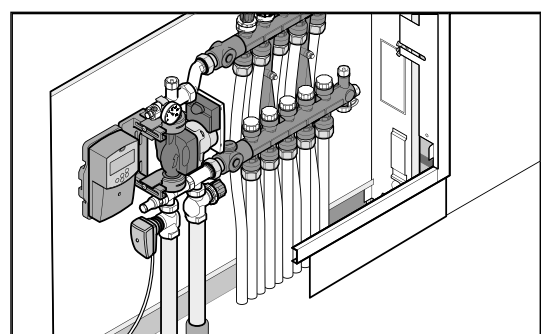
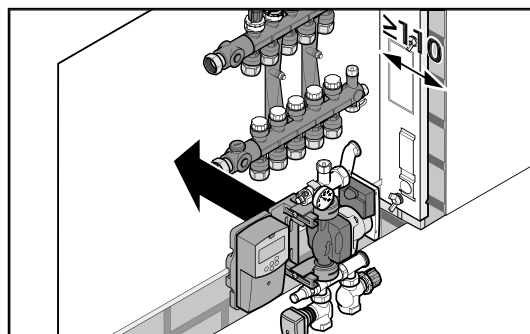
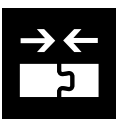
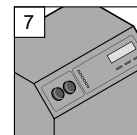
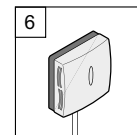
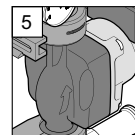
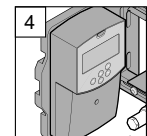
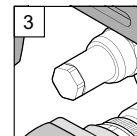
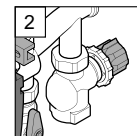
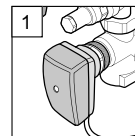
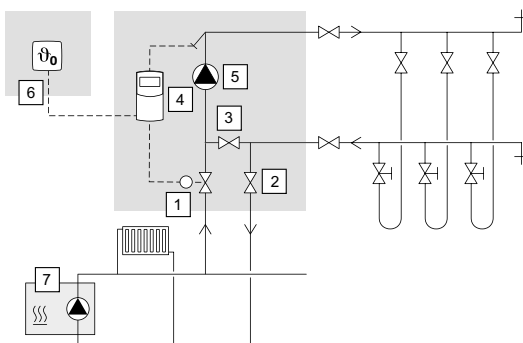

2 h



$P = 4 - 6 \text{ bar}$

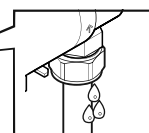

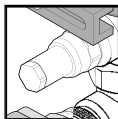
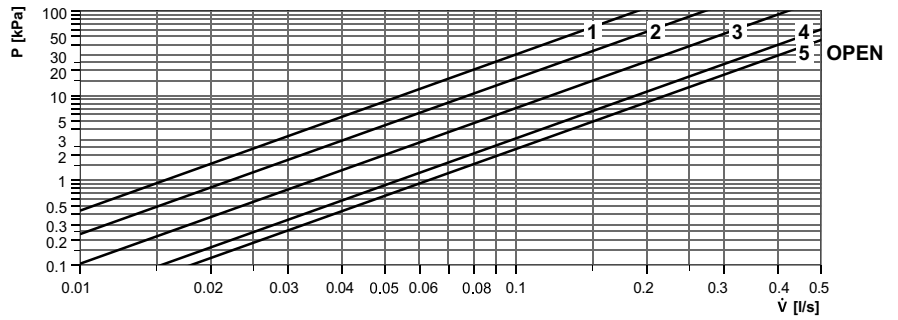
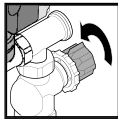
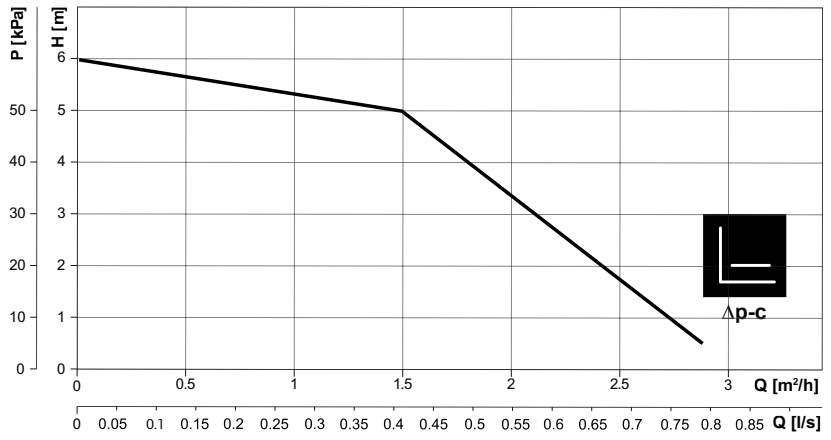
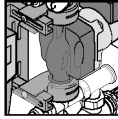

A
OPEN = Standard

B
CLOSE = Flush

C
100%
CLOSE

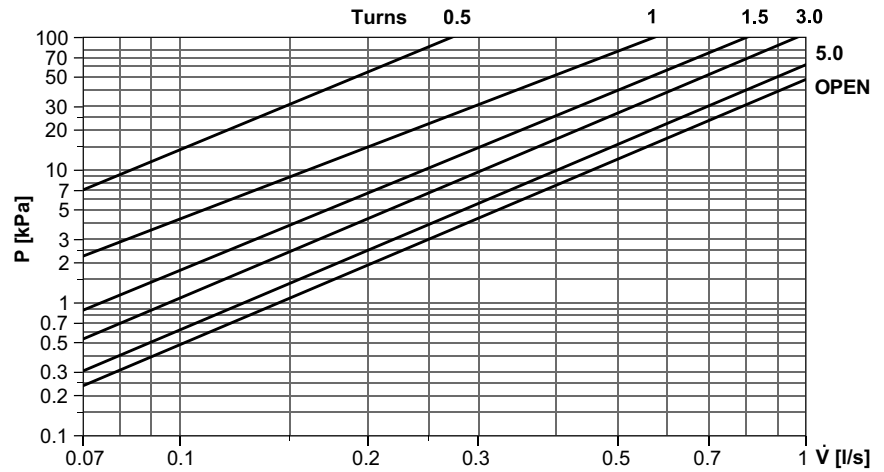

Uponor Vario PLUS manifold

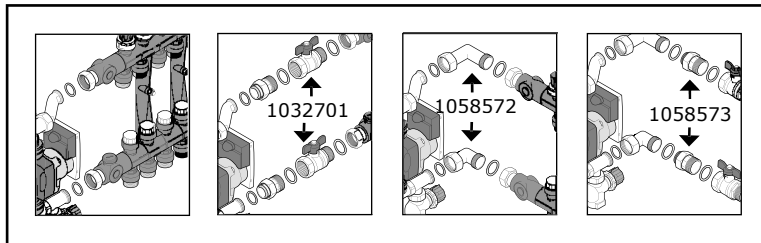

Uponor Vario B manifold

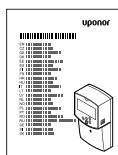
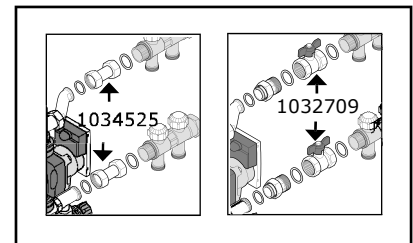

Uponor Corporation

1085121 10_2015_EN
 Production: Uponor AB, EL, Virsbo; SE

Uponor reserves the right to make changes, without prior notification, to the specification of incorporated components in line with its policy of continuous improvement and development.



www.uponor.com