

uponor

# Residential Plumbing

Installation Guide



**Uponor Residential Plumbing Installation Guide** is published by

**Uponor Inc.**

5925 148th Street West  
Apple Valley, MN 55124

USA

T 800.321.4739

F 952.891.2008

[uponor.com](http://uponor.com)

**Uponor Ltd.**

6510 Kennedy Road  
Mississauga, ON L5T 2X4

CANADA

T 888.994.7726

F 800.638.9517

© 2024 Uponor North America

All rights reserved.

Fourth Edition November 2024

First Printing January 2019

Printed in the United States of America

Uponor has used reasonable efforts in collecting, preparing, and providing quality information and material in this installation guide. However, system enhancements may result in modification of features or specifications without notice.

Uponor is not liable for installation practices that deviate from this installation guide or are not acceptable practices within the mechanical trades.

# Table of Contents

<b>Section 1: The Uponor Plumbing System</b>	<b>1</b>
Applications	1
Temperature and Pressure Ratings	2
Hydrostatic Temperature and Pressure Ratings	3
Excessive Temperature and Pressure Capability	4
Recirculation Systems	4
<b>Section 2: Working with Uponor PEX Piping</b>	<b>5</b>
Bending the Pipe	5
Bend Supports	6
Storing and Handling Guidelines	6
<b>Section 3: Making ProPEX® Connections</b>	<b>9</b>
Distance Between Fittings	9
General ProPEX Connection Tips	10
Making ProPEX Connections with Milwaukee® M12, M12 FUEL, M18, or M18 FUEL 2" ProPEX Expansion Tools	12
Making ProPEX Connections with Milwaukee M18 FORCE LOGIC ProPEX Expansion Tools	15
Making 3/8" ProPEX Connections	18
Disconnecting a ProPEX Brass Fitting	19
Troubleshooting ProPEX Connections	21
Proper Expander Tool and Head Maintenance	23
Brass Transition Fittings	24
Other Manufacturers' Pipe and Fittings	24
<b>Section 4: TotalFit™ Push-to-Connect Fitting System</b>	<b>25</b>
Making a TotalFit Connection	25
Removing a TotalFit Connection	25
Installation and Application Guidelines	26
General Guidelines	27
TotalFit Codes, Standards, and Listings	27
Warranty	28
<b>Section 5: Water Service</b>	<b>29</b>
Trench Bottom Preparation	29
Piping Embedment	30
Installation	30

Handling and Repairs . . . . .	31
Trace Wire. . . . .	31
Joining Methods and Fittings . . . . .	31
Water Service Disinfection . . . . .	31
ProPEX Water Meter Fittings and Valves . . . . .	32
Expansion Tanks. . . . .	32
<b>Section 6: Installation Methods . . . . .</b>	<b>33</b>
Below-Grade or In-Slab Installations . . . . .	33
Installing Uponor AquaPEX Piping in Wood-Frame Construction . . . . .	34
Piping Runs . . . . .	34
Recessed Light Fixtures. . . . .	35
Fluorescent Lighting. . . . .	35
LED Lighting . . . . .	36
Piping Supports: General Guidelines . . . . .	36
Piping Supports: Horizontal Runs. . . . .	36
Piping Supports: Vertical In-Wall Piping . . . . .	37
Strapping. . . . .	37
Bundling . . . . .	38
Spray-Foam Insulation . . . . .	38
Closed-Cell Spray Foam Insulation . . . . .	38
Icynene® Spray-Foam Insulation . . . . .	39
Uponor Logic Plumbing System . . . . .	39
Supporting Uponor Multiport Tees . . . . .	40
ProPEX Out-of-the-Wall Support System. . . . .	41
ProPEX Drop Ear LF Brass Elbows . . . . .	42
Metal Straight-Through Supports. . . . .	42
Grommets. . . . .	42
Water Hammer Arrestors . . . . .	42
Steel Plate Protectors . . . . .	42
Shower Valve Connections. . . . .	43
Hose Bibs . . . . .	43
ProPEX Copper Tub Ells . . . . .	43
ProPEX Copper Stub Ells . . . . .	44
Straight and Angle Stop Valves. . . . .	44
Installing Compression Connections. . . . .	45
Termiticide or Pesticide Treatment. . . . .	45

**Section 7: Pressure Testing and Water System Disinfection . . . . . 47**

Pressure Testing . . . . . 47

Water System Disinfection . . . . . 47

**Appendix A: Laying Out an Uponor Logic System. . . . . 49**

Uponor Logic Plumbing Systems vs. Conventional Thinking . . . . . 49

    Features and Benefits. . . . . 49

    Uponor Logic Plumbing. . . . . 50

    Trunk-and-Branch Plumbing . . . . . 51

    Homerun Plumbing . . . . . 52

    Two-Story Home: Planning Example . . . . . 53

    Slab-On-Grade Home: Planning Example . . . . . 57

**Appendix B: Standards, Listings, and Codes . . . . . 61**

Standards. . . . . 61

Listings . . . . . 62

Codes . . . . . 62

    Material Designation Code. . . . . 62

    Piping Identification . . . . . 63

    Print Stream Identification . . . . . 63

**Appendix C: Troubleshooting Tips and Tricks . . . . . 65**

Reforming Kinked Piping . . . . . 65

Thawing Frozen Piping . . . . . 66

**Appendix D: Installation Checklist . . . . . 67**

## Foreword

This installation guide is published for building officials, plumbing professionals, and contractors interested in Uponor professional plumbing systems. This manual describes general installation recommendations that use Uponor PEX® piping products. Always follow local code requirements.

**Note:** An Uponor plumbing system can include AquaPEX White, Red, Blue, White with Red Print, White with Blue Print, Reclaimed Water, Pre-Sleeved, Pre-Insulated, or ServicePEX™ pipe. For readability, this document will refer to Uponor PEX piping when information applies to any or all forms of Uponor PEX piping.

Uponor has used reasonable efforts in collecting, preparing, and providing quality information and material in this manual. However, system enhancements may result in modification of features or specifications without notice. For the most current technical information, go to the Uponor website at [uponor.com](http://uponor.com).

Uponor is not liable for installation practices that deviate from this manual or are not acceptable practices within the mechanical trades. Refer to the Uponor Residential Fire Safety System Installation Guide to install Uponor AquaPEX piping in Uponor fire safety systems.

Prior to installing Uponor plumbing systems, Uponor recommends all installers attend Uponor plumbing systems installation training performed by an Uponor trainer or manufacturer's representative. To schedule a training session at your business or job site, contact your local Uponor representative or call 800.321.4739.

Please direct any questions regarding the suitability of an application or a specific design to your local Uponor representative. For the name of your local representative, please call toll free 800.321.4739.

Throughout this document, there will be multiple references to the requirements of Local or National codes. Uponor recognizes the importance of consistent regulations and works closely with industry associations and code development bodies to ensure transparency, consistency, and safety.

It is important to understand the difference between a manufacturer's (Uponor) recommendation and the code requirement as it applies.

If there are differences between Uponor's recommendations and design parameters and the enforceable code language, it is critically important that the more restrictive criteria be followed. Where Uponor's recommendations are more restrictive than the adopted code, our limitations must be followed to ensure the product(s) perform as expected and remain covered under the Uponor Limited Warranty.

Uponor always recommends confirming that the products, design, and intended installation are acceptable to the local Authority Having Jurisdiction (AHJ) and comply with all local codes, ordinances, and regulations prior to installation.





## Section 1

# The Uponor Plumbing System

The Uponor plumbing system consists of the following PEX piping and plumbing components:

- AquaPEX White, Red, Blue, White with Red Print, White with Blue Print, Reclaimed Water, Pre-Sleeved, and Pre-Insulated pipe
- ProPEX® engineered polymer (EP) fittings
- ProPEX lead-free (LF) brass fittings
- ProPEX EP multiport tees
- Supports
- Finishes

PEX is an acronym for crosslinked polyethylene. The “PE” refers to the raw material used to make PEX (polyethylene), and the “X” refers to crosslinking the polyethylene across its molecular chains. The molecular chains are linked into a three-dimensional network that makes PEX remarkably durable within a wide range of temperatures and pressures.

Uponor manufactures PEX piping using a hot-crosslinking process. The actual crosslinking takes place during the extrusion process when the base polyethylene is above its melting temperatures. Classified within the industry as PEX-a piping, this

type of PEX is superior to other PEX types due to its consistent, uniform, and evenly crosslinked formula. Uponor AquaPEX also demonstrates a great resistance to chemical-dissolving agents. This unique structure is stable and inert, and it is unaffected by chemicals commonly found in plumbing and heating systems. For water system disinfection guidelines, refer to the **Water System Disinfection** section on **page 47**.

Uponor PEX pipe and ProPEX fittings are approved for use in national building codes. Always consult local building codes for approvals in specific jurisdictions. For a complete listing of Uponor AquaPEX pipe and ProPEX fittings standards, listings and codes, refer to **Appendix B**.

## Applications

Uponor PEX piping is versatile and has a broad range of uses.

- Potable hot- and cold-water distribution
- Fire protection systems
- Water reclamation systems
- Water service (see **Section 5** for details)
- Reverse osmosis systems
- Deionized water systems

Our extensive listings and history of system testing ensures Uponor AquaPEX piping is suitable for use in many types of residential applications, including, but not limited to, the following:

- Single-family homes
- Townhomes
- Apartments
- Condominiums

**Note:** For multifamily installations, including risers, pipe support, hanger spacing, expansion/contraction, firestopping, etc., refer to the Uponor PEX Piping Systems Design and Installation Manual (PDIM).

## Temperature and Pressure Ratings

Temperature and pressure ratings for PEX piping are determined by the Plastics Pipe Institute (PPI) as required by the ASTM F876 standard. It is important to understand the hydrostatic strength (ratings) on Uponor PEX piping does NOT take into account environmental or system factors which could affect system life. These factors could include, but are not limited to, water temperature and quality, use patterns, chlorine type and level, UV exposure, installation methods, etc. See **Table 1-1** for operating parameters.

The minimum burst pressure per ASTM F876 is 480 psi at 73°F (22.7°C) for ½" PEX and 475 psi at 73°F (22.7°C) for ¾" and larger PEX.

Additional supporting information can be found in PPI TN-53, *Guide to Chlorine Resistance Ratings of PEX Pipes and Tubing for Potable Water Applications*, regarding operating parameters.

System Type	Uponor PEX Maximum Operating Parameters		
	Temp.	Pressure	Velocity
Water service piping	See <b>Table 1-2</b>		10 ft./sec.
Domestic cold-water piping	See <b>Table 1-2</b>		10 ft./sec.
Domestic hot-water piping	140°F (60°C)	80 psi (5.5 bar)	8 ft./sec.
Domestic hot-water recirculation piping (dedicated)*	140°F (60°C)	80 psi (5.5 bar)	2 ft./sec.

**Table 1-1: Uponor PEX Maximum Operating Parameters**

\*Sized per the requirements stated in ASPE Plumbing Engineering Design Handbook (PEDH), Volume 2, Plumbing Systems

**Note:** For systems requiring pressures and/or temperatures beyond the recommended values, please contact Uponor Technical Services at 888.594.7726.

### Hydrostatic Temperature and Pressure Ratings

Refer to **Table 1-2** for the hydrostatic temperature and pressure ratings of Uponor PEX pipe for water service and domestic cold-water systems.

**Note:** ProPEX EP and LF brass fittings carry the same temperature and pressure ratings as Uponor AquaPEX pipe.

\*\*ServicePEX can satisfy the performance requirements of section F.7 of PPI TR-3 for polyethylene (PE) materials to qualify for a higher 0.63 design factor resulting in a temperature/pressure rating of 200 psi at 73.4°F (13.8 bar at 23°C).

Hydrostatic temperature and pressure ratings**	
°F/°C	psi/bar
<b>200.0/93.3</b>	<b>80/5.5</b>
190.0/87.8	90/6.2
<b>180.0/82.2</b>	<b>100/6.9</b>
170.0/76.7	106/7.3
160.0/71.1	111/7.7
150.0/65.6	117.8/0
140.0/60.0	123/8.5
130.0/54.4	128/8.8
120.0/48.9	134/9.2
110.0/43.3	139/9.6
100.0/37.8	145/10.0
90.0/32.2	151/10.4
80.0/26.7	156/10.8
<b>73.4/23.0</b>	<b>160/11.0</b>
60.0/15.6	168/11.6
50.0/10.0	173/11.9
40.0/4.4	179/12.3

**Table 1-2: Hydrostatic Temperature and Pressure Ratings for Uponor PEX in water service and domestic cold-water systems**

## Excessive Temperature and Pressure Capability

In the event of an equipment or system malfunction, Uponor PEX is capable of withstanding temperatures of up to 210°F at 150 psi (99°C at 10 bar) for a maximum of 48 hours until repairs can be made.

**Note:** Excessive temperature and pressure requirements are meant solely to demonstrate that PEX piping can temporarily withstand intermittent elevated values and shall not be used as system design parameters.

## Recirculation Systems

Based on extensive history of use and independent-laboratory testing, Uponor AquaPEX piping and ProPEX fitting systems are approved for use in timed, sensor-activated, self-activated, or continuous hot-water recirculation systems operating at the following parameters:

- Temperatures not to exceed 140°F (60°C)
- Pressure not to exceed 80 psi (5.5 bar)
- Velocity not to exceed 2 feet per second
- Chlorine levels for normal operation not to exceed 4 parts per million (ppm)

**Note:** Uponor does not promote the use of continuous recirculation due to excessive energy waste.

For the greatest effectiveness, use a hot-water recirculation line in an Uponor Logic plumbing layout. See **Appendix A** for details.

**Note:** Uponor AquaPEX pipe meets the highest requirement per ASTM F876 and F877 for chlorine resistance at end-use conditions **100 percent of the time at 140°F (60°C)**.

## Section 2

# Working with Uponor PEX Piping

### Bending the Pipe

The flexible nature of Uponor AquaPEX piping allows it to bend with each change in direction, minimizing required fittings on the job. The minimum bend radius of Uponor AquaPEX piping is six times the outside diameter (O.D.).

To alleviate stress on ProPEX connections and fittings, do not change direction immediately after a ProPEX connection. To aid in determining whether or not the directional change is too soon, refer to **Figure 2-2** and **Figure 2-3**.

Uponor recommends a minimum of two times the O.D. of the pipe as the minimum distance before changing direction; however, it is up to the installer to use best judgment.

Bend supports are available for pipe sizes up to 1" to facilitate 90-degree rigid bends (see **Figures 2-4** and **2-5** on the following page). When minimum distance cannot be achieved with a bend support, Uponor recommends using a ProPEX elbow.

For piping larger than 1", Uponor recommends using ProPEX elbows, unless adequate space is available for a proper bend.

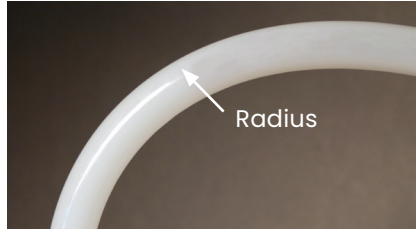

**Figure 2-1: Bend Radius**

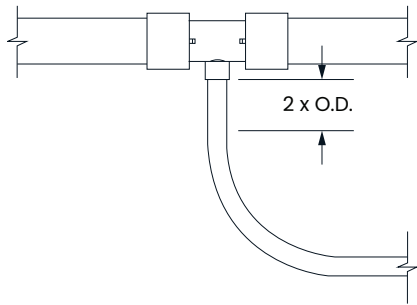

**Figure 2-2: Correct Bending**

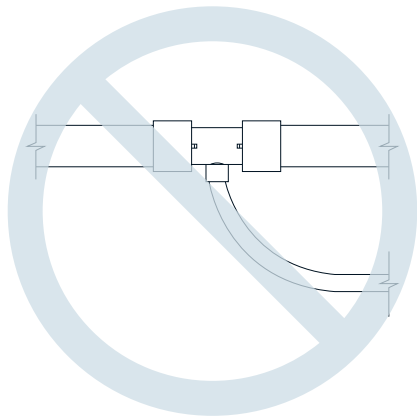

**Figure 2-3: Incorrect Bending**

## Bend Supports

Uponor offers various bend supports to secure piping in a 90-degree bend. Metal and plastic snap-on bend supports are available for  $\frac{3}{8}$ ",  $\frac{1}{2}$ ", and  $\frac{3}{4}$ " piping. PVC conduit supports are available for up to 1" piping and are also appropriate for use when exiting a slab to protect the piping and control direction.

Metal and plastic drop-ear bend supports are available for  $\frac{3}{8}$ " and  $\frac{1}{2}$ " piping to provide a 90-degree exit from a standard 2" x 4" (or larger) stud wall or floor. To install, fasten the flange to the front edge of the stud for support. Use a horizontal brace to position the drop-ear bend support between two studs.



**Figure 2-4: Support for 90-Degree Bend**



**Figure 2-5: Drop-Ear Bend Supports**

**Note:** Use all Uponor plumbing components to ensure system performance. Using non-Uponor parts may impact system warranty.

---

## Storing and Handling Guidelines

Although not comprehensive, the following highlights the most common guidelines when storing and handling Uponor PEX piping and ProPEX fittings.

- Do not store outdoors.
- Keep in the original packaging until time of installation.
- Install Uponor systems according to the installation instructions. Failure to follow the instructions and installation guidelines in this manual can compromise the performance of the system.
- Do not use where temperatures and pressures exceed ratings.
- Do not use or store Uponor AquaPEX white pipe or ProPEX EP fittings where they will be exposed to direct sunlight for more than one month.
- Do not use or store Uponor AquaPEX red or blue pipe where it will be exposed to direct sunlight for more than six months.
- Do not reuse or reclaim ProPEX EP or LF brass fittings.

- Do not apply an open flame.
- Do not weld or glue the pipe. Uponor approves the temporary use of adhesive tape during installation provided the tape is removed after installation is complete.
- Uponor AquaPEX may be connected directly to electric water heaters, as well as power-vented gas water heaters where allowed by local code.
- Do not install within 6" of any gas appliance vents. One exception is double-wall B-vents, which have a minimum clearance of 1".
- Do not install within 12" (over or under) of any recessed light fixture unless protected with suitable insulation.
- When installing Uponor AquaPEX within 6" of fluorescent lighting, insulate the pipe from heat exposure with closed-cell or fiberglass pipe insulation. Ensure the pipe is protected 18" beyond each side of the fluorescent light source and maintains a minimum clearance of 1" from the fluorescent light source.
- When pipe is directly under or within 3 feet laterally of fluorescent lighting, sleeve the pipe with HDPE poly sheathing, closed-cell pipe insulation, or any suitable pipe covering material that is black in color to protect it from UV exposure. Ensure the coverage extends 18" beyond each side of the fluorescent light source.
- If installing Uponor AquaPEX within 18" of an LED light source, cover the pipe with foam insulation or some other protective covering. Such protection should cover the pipe to a distance of at least 18" from the light source.
- Do not use to convey natural gas.
- Do not solder, braze, weld, or fusion-weld within 18" of any Uponor AquaPEX pipe or ProPEX EP fitting in the same waterline. Make sweat connections prior to making the ProPEX connection.
- Do not install Uponor AquaPEX pipe between the tub/shower valve and tub spout.
- Do not use Uponor AquaPEX pipe for an electrical ground.
- Use only approved and appropriate firestop materials with Uponor AquaPEX pipe.
- Do not subject to blunt impact.
- Do not spray on or allow organic chemicals, strong acids, or strong bases to come into contact with Uponor AquaPEX pipe or ProPEX EP fittings.
- Do not use petroleum or solvent-based paints, greases, or sealants on Uponor AquaPEX pipe or ProPEX EP fittings.

- Do not allow rodents, insects, or other pests to come into contact with Uponor AquaPEX pipe or ProPEX EP fittings. See **page 45** for recommended guidelines on termiticide and pesticide treatment.
- During remodeling or ceiling repair, take appropriate precautions to protect from damage.
- Do not install in soil contaminated with solvents, fuels, organic compounds, pesticides, or other materials that may cause permeation, corrosion, degradation, or structural failure. If necessary, perform a chemical analysis of the soil or groundwater to determine installation acceptability. Check local codes for additional requirements. For more information, refer to the termiticide or pesticide treatment section on **page 45**.
- When using urethane foam insulation/sealant, cover ProPEX EP fittings with a protective (PE, foil, etc.) wrap to prevent direct contact.
- Do not expose ProPEX EP fittings to bending loads greater than 100 lbs.
- When transitioning to copper, do not press ProPEX LF brass copper sweat transition fittings (LF450 and LF451 parts).



## Section 3

# Making ProPEX Connections

Uponor ProPEX ASTM F1960 (CAN/CSA B137.5) cold-expansion fittings make solid, permanent, manufactured connections without the need for torches, glues, solder, flux, or gauges. The unique shape memory of Uponor PEX piping forms a tight seal around the fitting, creating a strong, reliable connection. This section shows how to make proper ProPEX connections using one of the following tools.

- Milwaukee M12, M12 FUEL, M18, and M18 FUEL 2" ProPEX expansion tools
- Milwaukee M18 FORCE LOGIC ProPEX Expansion Tool

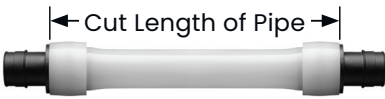

**Figure 3-1: Distance Between Fittings**

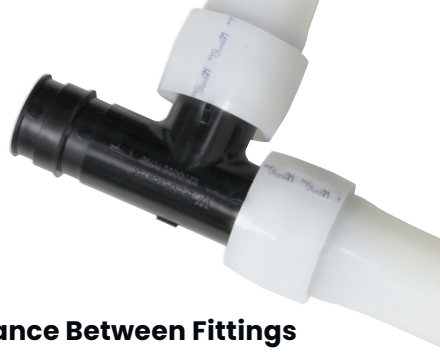

### Distance Between Fittings

Uponor requires a minimum distance between ProPEX fittings to avoid damaging the fittings during installation and to protect against elevated stress on the pipe and fittings. Refer to **Table 3-1** for the minimum distance between fittings, which is expressed as cut length of pipe.

Nominal Fitting Size	Cut Length of Pipe
½"	2"
¾"	3"
1"	3½"
1¼"	4½"
1½"	4½"
2"	6" or 6¾"*
1½"	7½"
3"	9"

**Table 3-1: Minimum Distance Between ProPEX Fittings**

\*6¾" for Milwaukee M18 FUEL 2" ProPEX Expansion Tool.

## General ProPEX Connection Tips

- If the fitting does not slide into the piping all the way to the stop, immediately remove it from the piping and expand the piping one final time.  
**Note:** To avoid over-expanding the piping, do not hold the piping in the expanded position.
- **Table 3-2** shows the recommended number of expansions. Experience, technique, and weather conditions influence the actual number of expansions. Fewer expansions may be necessary under certain conditions. The correct number of expansions is the amount necessary for the piping and the shoulder of the fitting to fit snugly together.
- Ensure the ProPEX ring rests snugly against the fitting shoulder. If there is more than  $\frac{1}{16}$ " (1 mm) between the ring and the shoulder of the fitting, the connection must be replaced. Square cut the piping 2" away from the fitting for  $\frac{3}{8}$ " to 1" pipe, 3" away for  $1\frac{1}{4}$ " to 2" pipe, and 5" away for  $2\frac{1}{2}$ " and 3" pipe prior to making the new connection.
- Brass ProPEX fittings can be disconnected and reused. EP fittings must be discarded. Be sure to follow the recommended minimum distance between ProPEX fittings shown in **Table 3-1**.

Pipe Size	Milwaukee ProPEX Expansion Tools					Uponor ProPEX Expander Tools		
	M12 with Standard Heads (2432)	M12 FUEL with RAPID SEAL™ Heads (2532)	M18 (2632)	M18 FUEL 2" (2932)	M18 FORCE LOGIC (2633)	Manual	100/150	201
3/8"	6-7	6-10	5	5-7	—	5	7	—
1/2"	7-8	5-8	9	7-9	—	4	4	—
5/8"	9-10	6-10	9	8-9	—	9	9H	—
3/4"	11-12	7-12	10	9-11	—	14	7H	—
1"	17-18	12-18	19	12-13 (or 7-8H)	—	—	7H	—
1 1/4"	—	—	9	9-10H	—	—	8H	—
1 1/2"	—	—	10	8-9H	—	—	—	—
2"	—	—	—	9-10	4	—	—	5H
2 1/2"	—	—	—	—	5	—	—	—
3"	—	—	—	—	7	—	—	—

**Table 3-2: Recommended Number of Expansions for 3/8" to 3" Piping at 73.4°F (23°C)**

**Note:** "H" in the table refers to Uponor H-series expander heads.

## Making ProPEX Connections with Milwaukee M12, M12 FUEL, M18, or M18 FUEL 2" ProPEX Expansion Tools

**Note:** All standard Uponor expander heads are compatible with the M12 and M18 tools. Uponor expander heads will not auto-rotate on the Milwaukee tools (only Milwaukee expansion heads will auto-rotate on the M12 and M18). H-heads are not compatible with Milwaukee tools and Milwaukee heads are not compatible with Uponor tools. Milwaukee heads are easily distinguished by color coding and the Milwaukee logo.

**Important!** Making expansions are slightly different when using a tool that features auto rotation. When making a ProPEX connection, be sure to follow the guidelines for the tool you are using in your application.

1. Square cut the PEX piping perpendicular to the length of the piping. Remove all excess material or burrs that might affect the fitting connection
2. Slide the ProPEX ring over the end of the piping until it reaches the stop edge. If using a ProPEX ring without a stop edge, extend the ring over the end of the piping no more than  $\frac{1}{16}$ " (1mm).

**Important!** If making a  $\frac{3}{8}$ " ProPEX connection, first expand each side of the ring before placing it on the piping. Refer to the "Making  $\frac{3}{8}$ " ProPEX connections" instructions on **page 18** for further information.

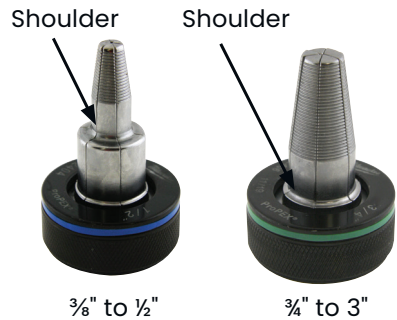

**Figure 3-2: Milwaukee Expansion Heads**

### With Auto Rotation (Standard Milwaukee Heads)

3. Milwaukee ProPEX expansion tools come with built-in auto rotation. If using a Milwaukee expansion head, simply hold the piping and tool in place while holding the trigger to expand the piping. The head will automatically rotate to ensure the piping is evenly expanded. Continue expanding and rotating until the piping and ring are snug against the shoulder on the expander head. See **Table 3-2** for the recommended number of expansions for each piping size.

**Note:** Do not force the pipe onto the expander head. Ensure the expander head is rotating during each expansion.

### Without Auto Rotation (Standard Uponor Heads)

4. Press the trigger to expand the piping.
5. Release the trigger, remove the head from the piping, rotate it  $\frac{1}{8}$  turn and slide the head back into the piping. Continue expanding and rotating until the piping and ring are snug against the

shoulder on the expander head. See **Table 3-2** for the recommended number of expansions.

**Important!** Rotating the tool between expansions will provide smooth, even expansion of the piping. Failure to rotate the tool will cause deep grooves in the piping which can result in potential leak paths.

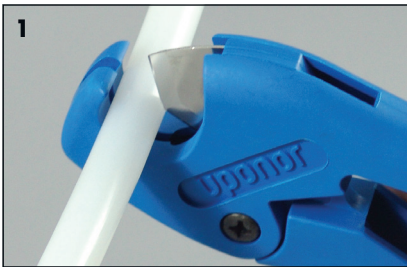

**Figure 3-3: Expansion with Milwaukee M12, M12 FUEL, M18, and M18 FUEL 2" ProPEX Expansion Tools**

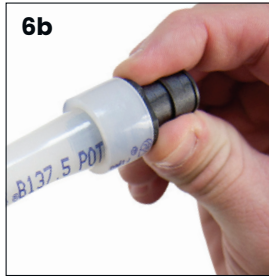

**Figure 3-4: Inserting ProPEX Fitting into 1/2" Uponor PEX Piping**



**Figure 3-5: Inserting ProPEX Fitting into 1" Uponor PEX Piping**

6. After the final expansion, immediately remove the tool and insert the fitting. Ensure the piping and ring fit snugly against the shoulder of the fitting.

**Important!** Only perform the necessary number of expansions. DO NOT over expand the pipe. You should feel some resistance as the fitting goes into the piping. If you do not feel any resistance, the piping may be over expanded and will require additional time to shrink over the fitting.



**Figure 3-6: ProPEX Coupling**



**Figure 3-7: ProPEX Tee**



**Figure 3-8: Expansion with Milwaukee M18 ProPEX Expansion Tool**

## Making ProPEX Connections with Milwaukee M18 FORCE LOGIC ProPEX Expansion Tools

### FORCE LOGIC Expansion Head Installation

The Milwaukee FORCE LOGIC ProPEX Expansion Tool for 2", 2½", and 3" Uponor PEX pipe features an auto-rotating head with specially designed alignment cogs. This requires slightly different head installation than the M12 and M18 ProPEX expansion tools for ¾" to 1½" pipe sizes.

1. Remove the battery pack and place the FORCE LOGIC tool in the upright position (cone up).



**Figure 3-9: FORCE LOGIC Expansion Head Installation**

2. Verify the expansion cone is fully retracted.
3. Screw the head onto the tool (clockwise). Hand-tighten securely. Do not over tighten. Ensure the expansion head fits flush against the tool.

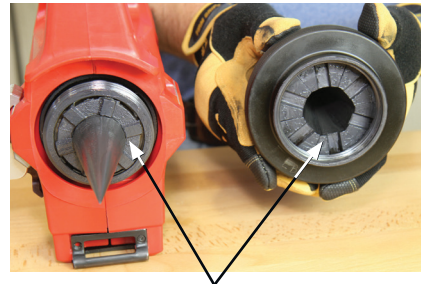

Auto-Rotate Teeth

### Figure 3-10 FORCE LOGIC Expansion Head Auto-Rotate Teeth

4. Check the installation.
  - a. Ensure the head segments do not "flower"

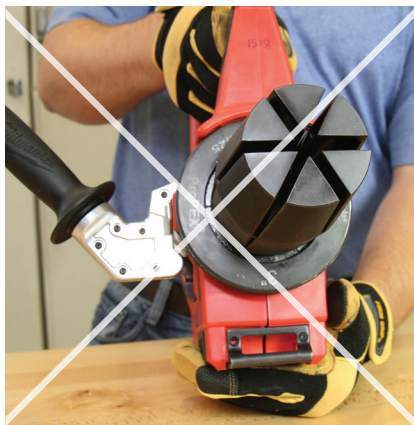

**Figure 3-11: Incorrect Expansion Head "Flowering"**

- b. If the head flowers, correct the installation by loosening the head slightly and rotating the segments until they engage in the cogs. Re-tighten the head.



**Figure 3-12: Correct Expansion Head Alignment**

- c. Rotate the six expansion segments in the clockwise direction. They will rotate freely. They should not rotate counter clockwise.
- d. The expansion head collar will fit flush against the tool.

## Making a ProPEX Connection

1. Square cut the pipe perpendicular to the length, and remove all excess material or burrs.



**Figure 3-13: Cut Pipe**

2. Slide the ProPEX ring over the end of the piping until it reaches the stop edge.



**Figure 3-14: Add Ring**



**Figure 3-15: Ensure Ring Reaches Stop Edge**



3. The tool features auto rotation so the head will automatically rotate to ensure the piping is evenly expanded.

**Note:** To cancel the expansion process quickly, pull and release the trigger.

4. Press the trigger to initiate the rotation of the head. A green light will turn on and the work light will blink. Insert the pipe and ring and release the trigger. When the expansion head has reached its maximum diameter, it will retract.

**Important!** Do not force the pipe and ring on the head during any expansion.

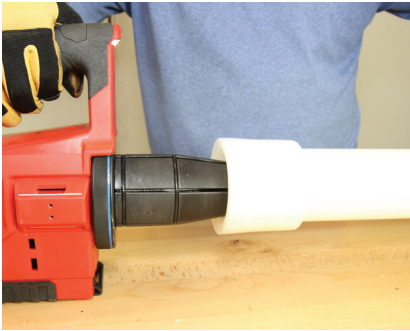

**Figure 3-16: Begin Expanding**

5. After the tool has retracted, the green indicator light blinks three times. Press the trigger and repeat the expansion process.

6. Repeat the process until the pipe and ring are snug against the shoulder of the expansion head. Repeat the expansion one or two more times depending on the ambient temperature.

**Note:** Colder temperatures require fewer expansions.



**Figure 3-17: Expand to Shoulder**

7. After final expansion, immediately remove the tool and insert the fitting.



**Figure 3-18: Insert Fitting**

## Making $\frac{3}{8}$ " ProPEX Connections

When making a  $\frac{3}{8}$ " ProPEX connection, expand the ring once on each side to properly fit over the piping. Refer to the following instructions to make a  $\frac{3}{8}$ " ProPEX connection.

1. Square cut the PEX piping perpendicular to the length of the piping. Remove all excess material or burrs that might affect the fitting connection.



**Figure 3-19: Uppor Pipe Cutter**

2. Expand each side of the ring once.

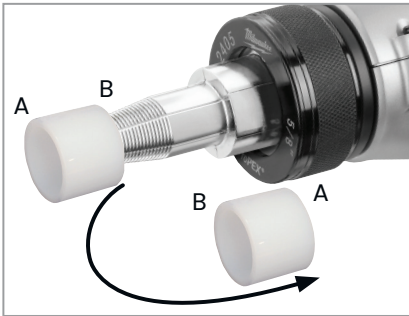

**Figure 3-20: Expand Each Side of the Ring**

3. Slide the expanded ring over the end of the piping. Extend the end of the ring over the end of the piping no more than  $\frac{1}{16}$ " (1 mm).

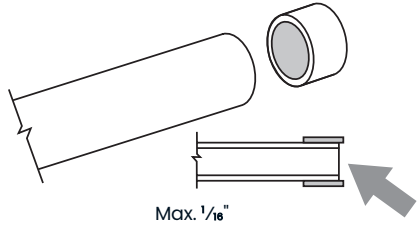

**Figure 3-21: Slide the Expanded Ring over the End of the Piping**

4. After the ring is on the piping, continue with the regular steps for making a proper connection with your specific tool.

### Important Tips for a Proper $\frac{3}{8}$ " ProPEX Connection

- The thicker  $\frac{3}{8}$ " ProPEX Ring shrinks over the fitting faster than larger-sized rings.
- When the temperature is below 40°F (4.4°C), fewer expansions are required.

## Disconnecting a ProPEX Brass Fitting

ProPEX brass and EP fittings are manufactured connections that can be concealed in walls, ceilings, and floors. When necessary, ProPEX brass fittings can be disconnected.

**Important!** EP fittings cannot be reclaimed.

Refer to the following guidelines for disconnecting a ProPEX brass fitting.

1. Ensure the system is not pressurized.
2. Use a utility knife to carefully cut through the ProPEX ring.

**Important!** Do not heat the ring prior to cutting it. Take care to cut only the ring and not the piping or fitting. Gouges in the fitting may result in leaks. If you accidentally damage the fitting, you must discard it.



**Figure 3-22: Cut Ring**

3. Remove the ProPEX ring from the piping.



**Figure 3-23: Remove Ring**

4. After removing the ring, apply heat directly around the fitting and piping connection.

**Do not use open flame.** Gently work the piping back and forth while pulling slightly away from the fitting until the piping separates from the fitting.



**Figure 3-24: Heat Connection**



**Figure 3-25: Work Piping Back and Forth**

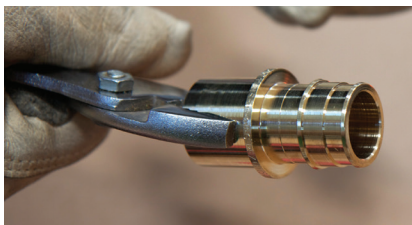

**Figure 3-26: Remove Fitting**

5. After removing the fitting, measure:
  - 2" (50.8 mm) minimum for  $\frac{3}{8}$ " to 1" pipe
  - 3" (76.2 mm) minimum for 1 $\frac{1}{4}$ " to 2" pipe
  - 5" (127 mm) minimum for 2 $\frac{1}{2}$ " and 3" pipe



**Figure 3-27 Measure from End of Pipe**

6. Square cut the piping at the proper marking.



**Figure 3-28: Cut Pipe at Marking**

7. Allow the fitting to cool before making the new connection.
8. Use a new ProPEX ring and follow the steps to make a new connection.

## Troubleshooting ProPEX Connections

Trouble-free ProPEX installations begin with a tool that is maintained in proper working condition. If the tool or segment fingers are damaged, it is very difficult to make a proper connection. Refer to the following guidelines to assist with challenges in the field.

### Fittings Won't Seal

- Make sure the expander head is securely tightened onto the tool.
- Ensure the segment fingers are not bent. If the head does not completely close when the drive unit is fully retracted or the handles of the manual tool are open, replace the head.
- Examine the tool for excess grease on the segment fingers. Remove excess grease prior to making connections.
- Check the fitting for damage. Nicks and gouges will cause the fitting to leak.
- Make sure the internal driver cone is not damaged or bent.

- Make sure the last expansion is not held in the expanded position before the fitting is inserted. You should feel some resistance as the fitting goes into the piping. If you do not feel any resistance, the piping may be over expanded and will require additional time to shrink over the fitting.

- Be sure to rotate the tool  $\frac{1}{8}$  turn after each expansion to avoid deep grooves in the piping which can result in potential leak paths.

### Expansion is Difficult

- Make sure the internal cone is properly greased.

### Expansion Head Slips Out of Piping when Making Expansions

- Ensure the piping and ProPEX ring are dry.
- Make sure that grease is not getting into the piping.
- Examine the segment fingers to ensure they are not damaged or bent.

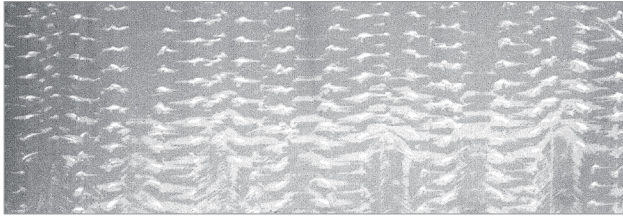

**Figure 3-29: Expansion with Proper Rotation**

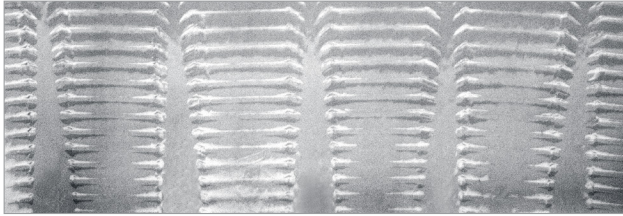

**Figure 3-30: Expansion without Proper Rotation**

### **ProPEX Ring Slides Down Piping During Expansion**

- Ensure your hands are clean while handling the piping. Any sweat or oils on your hands can act as a lubricant. Due to the smoothness of PEX, any form of lubricant can cause the ProPEX ring to slide down the piping during expansion.
- If you anticipate the ProPEX ring may possibly slide down, position the ring with the pipe recessed  $\frac{1}{8}$ " from the end of the ring. Begin the expanding and ensure that the pipe and ring expand together and the ring does not move. Continue with the normal number of expansions.

- Place your thumb against the ProPEX ring to help support it and feel for any movement. If caught early, you can slide the ring up the piping and expand as described in the previous bullet point.

### **More Than the Recommended Number of Expansions Are Needed to Make a Connection**

- Ensure the head is hand-tightened to the expander tool.
- Examine the segment fingers for damage.
- Be sure to completely cycle the tool on each expansion (i.e., close the manual tool handle or release the trigger).

## Cold-Weather Expansions

- Uponor recommends the use of the Milwaukee M12 FUEL ProPEX expansion tool with RAPID SEAL™ heads for cold-weather installation of 3/8" to 1" Uponor piping systems.
- Temperatures affect the time required for the piping and ring to shrink onto the fitting. The colder the temperature, the slower the contraction time.
- Warming ProPEX fittings and ProPEX rings reduces contraction time. Put fittings and rings in your pockets prior to installation to keep them warm.
- Fewer expansions are necessary in temperatures below 40°F (4.4°C).



**Figure 3-31: Milwaukee RAPID SEAL 1" Head**

**Note:** Do not use a heat gun on EP fittings to speed up the contraction time as this could result in damage to the fitting.

---

## Proper Expander Tool and Head Maintenance

- Use a lint-free cloth to apply a light coat of lubricant to the cone prior to making any ProPEX connections.
- If used regularly, apply the lubricant daily to the cone of the ProPEX expander tool. Failure to keep these tools lubricated may result in improper connections.
- Keep all other parts of the tool free from lubricant.
- Once a month, soak the heads in degreasing agent to remove any grease from between the segments. Clean the cone using a clean, dry cloth.



**Caution:** Excessive lubrication may result in improper connections.

Only use a small amount of lubrication to keep the tool working properly.

## Brass Transition Fittings

Uponor offers a comprehensive line of LF brass sweat transition fittings, as well as copper press transition adapters. For the complete offering, refer to the Uponor Product Catalog.

**Note:** When transitioning to copper press, use ProPEX LF Brass Copper **Press** Adapters (LFP450 and LFP451 parts). **DO NOT** press ProPEX LF Brass Copper **Sweat** Adapters (LF450 and LF451 parts).

## Other Manufacturers' Pipe and Fittings

Uponor approves the use of its Uponor AquaPEX piping with any type of SDR9 PEX fitting providing that fitting standard is marked on the print string on the pipe (e.g., F1960, F1807, etc.). Compression fittings (offered by Uponor or other manufacturers) can be installed on Uponor pipe. Be sure to install compression fittings with an insert stiffener to ensure the pipe wall does not collapse under compression, compromising the connection.

**Note:** Uponor cautions the use of other manufacturer's PEX pipe with Uponor ProPEX rings as well as using other manufacturer's expansion rings with Uponor AquaPEX (PEX-a) pipe. Because of the lower degree and uniformity of crosslinking in PEX-b and PEX-c pipe, stress cracking of the PEX-b and PEX-c pipe wall can occur during expansion, compromising the strength of the fitting connection.

Additionally, the 25-year limited warranty for Uponor AquaPEX systems is only valid when using both Uponor AquaPEX pipe and Uponor ProPEX fittings. Mixing the ProPEX rings with other manufacturer's PEX pipe or mixing other manufacturer's expansion rings with Uponor AquaPEX pipe will limit the warranty. For complete warranty details, refer to [uponor.com](https://www.uponor.com).



## Section 4

# TotalFit Push-to-Connect Fitting System

TotalFit is the professional-grade engineered polymer (EP) push-to-connect solution that provides greater value for residential projects with the same versatility and speed as brass push-to-connect fittings for PEX, PE-RT, CPVC, and copper piping systems.

Use Uponor TotalFit push-to-connect fittings to repair potable hot-water and cold-water distribution piping systems in single-family homes, townhomes, apartments, and condominiums.

### Making a TotalFit Connection

1. Square cut the piping perpendicular to the length of the pipe.

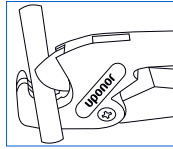

2. Remove excess material or burrs using the deburr and depth tool.

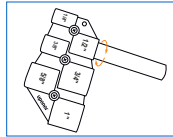

**Important!** Be sure to protect the pipe from nicks, scratches, and gouges during install as those can affect the integrity of the fitting connection.

3. Continue using the TotalFit Deburr and Depth Tool to mark the appropriate insertion depth on the pipe. Below are the recommended depths.

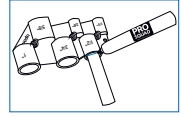

- 1/2": 0.875" (7/8")
- 3/4": 1"
- 1": 1.125" (1 1/8")

4. If using flexible PEX or PE-RT, install the insert inside the pipe first before making the connection. The insert provides added strength to the connection for flexible pipe.

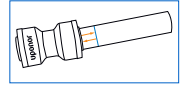

**Note:** Failure to use the insert will void the warranty.

**Important!** The PEX/PE-RT insert adds about 1/16" to the pipe length. Keep this in mind when making the insertion depth marking on PEX and PE-RT pipe.

5. Insert the pipe into the fitting.

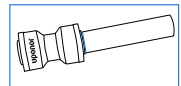

6. Confirm the fitting is fully inserted by aligning the edge of the fitting depth mark on the pipe.

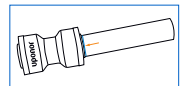

## Removing a TotalFit Connection

1. Attach the appropriately sized removal tool to the pipe.
2. Press it back against the release collar on the fitting. This will disengage the grab ring.
3. Remove the pipe from the fitting.

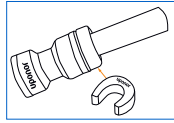

**Important!** Be sure to inspect the fitting for any damage before using it on a future connection. Also, while it is acceptable to disconnect and reuse TotalFit push-to-connect fittings, Uponor does not recommend installing fittings with repeated reuse in permanent applications.

## Installation and Application Guidelines

### In Slab, Direct Burial, or Behind Walls

TotalFit push-to-connect fittings are approved by the Uniform Plumbing Code and International Plumbing Code for installation in a concrete slab, direct burial in the soil, and behind walls without access panels. For direct burial in soil or concrete, cover the fittings with 4 to 6 mil poly wrap.

## Tub and Shower Valve Repairs

TotalFit is approved for use in repairing tub and shower downspouts. However, **do not** use PEX or PE-RT in this application as it may create excessive back pressure. This will cause the valve to remain slightly open, causing the shower head to drip water while using the tub spout. In these applications, only use TotalFit with copper or CPVC pipe.

## Hot-water Heater Connections

TotalFit and Uponor AquaPEX® pipe are approved for installation directly to electric water heaters as well as power-vented gas water heaters (where allowed by local code). However, **do not** install TotalFit or Uponor AquaPEX pipe within 6" (15.2 cm) of a vent pipe for direct or gravity-vented appliances. Be sure to maintain a minimum 1" (25 mm) distance from double-wall B vents or zero-clearance plastic vents.

## Spray-foam Insulation

Avoid any contact with spray-foam insulation. Cover the fittings with an overwrap of 4 to 6 mil poly or other suitable waterproof protection.

## Chemical Compatibility

Do not use petroleum-based or solvent-based paints, greases, or sealants on TotalFit products, and do not expose to organic chemicals, strong acids, strong bases, or immerse in saltwater. Only use PTFE thread seal tape (with a minimum of three wraps) to seal male and female adapters. If using thread sealant paste in addition to tape, consult the paste manufacturer for compatibility with polymer fittings.

## UV Exposure

TotalFit push-to-connect fittings are resistant to damage from UV light and do not require special care to protect from exposure. Always check the pipe manufacturers' installation guidelines for any additional safety precautions.

## System Disinfection

When required, disinfect Uponor AquaPEX pipe and TotalFit push-to-connect fittings in accordance with the Uponor AquaPEX Plumbing System Disinfection Guidelines.

## General Guidelines

- Do not store outdoors; keep in the original packaging until ready for installation.
- Do not use to convey natural gas or compressed air.
- Do not use where temperatures and pressures exceed limits.
- Do not weld, glue, use adhesives, or adhesive tape.
- Do not solder, braze, weld, or fusion-weld within 18".
- Do not apply heat with a heat gun or open flame.
- Do not subject to blunt impact.
- Do not allow rodents, insects, or other pests to come into contact with the product. Refer to **page 45** for termiticide and pesticide treatment guidelines.
- Do not expose to bending loads greater than 100 lbs.

## TotalFit Codes, Standards, and Listings

Uponor TotalFit push-to-connect fittings are designed and manufactured to all applicable industry codes, standards, and listings. However, be sure to check with your local water authority for compliance. For further details, refer to the product submittals on [uponor.com](https://www.uponor.com).

**Listing:** IAPMO

**Codes:** International Plumbing Code (IPC), Uniform Plumbing Code (UPC), and National Plumbing Code of Canada (NPCC)

## TotalFit Standards

Standards	
ASSE-1061	Standard specification for push-to-connect fittings
ASTM F876	Standard specification for cross-linked polyethylene (PEX) piping
ASTM F877	Standard specification for cross-linked polyethylene (PEX) plastic hot- and cold-water distribution system
CAN/CSA B137.5	Crosslinked polyethylene (PEX) piping systems for pressure applications
NSF/ANSI 14	Plastics piping system components and related materials ANSI/NSF
NSF/ANSI/CAN 61	Drinking water system components – health effects
NSF 372	Drinking water system components – lead content

**Table 4-1: TotalFit Standards**

### Warranty

Uponor warrants TotalFit push-to-connect fittings shall be free from defects in material and workmanship for 25 years if used on Uponor or other manufacturers' pipe that complies with the below standards.

- PEX (a, b, or c) – ASTM F876 or CSA B137.5
- Copper (K, L, or M) – ASTM B88
- CPVC – ASTM D2846 or CSA B137.6
- PE-RT – ASTM F2769

## Section 5

### Water Service

Uponor ServicePEX™ pipe is manufactured and designed for use in water service applications. The pipe is certified to the AWWA C904 Standard and is listed to IPC, IRC, and UPC requirements.

The pipe has the following hydrostatic **ratings** per **PPI TR-4**:

- 160 psi at 73°F (11 bar at 23°C)
- 100 psi at 180°F (6.9 bar at 82°C)

**Note:** ServicePEX can satisfy the **performance requirements** of section F.7 of **PPI TR-3** for polyethylene (PE) materials to qualify for a **higher 0.63 design factor** resulting in a temperature/pressure rating of **200 psi at 73.4°F (13.8 bar at 23°C)**.

Note that while the pipe features a PEX 5306 marking for six months of UV resistance, the pipe has been **tested and proven** to withstand **12 months of UV exposure**.

Always refer to local code for application use and installation requirements.



**Figure 5-1: Uponor ServicePEX pipe for water service**

### Trench Bottom Preparation

To achieve a satisfactory installation, it is essential that the soil provides stable and continuous support for the piping.

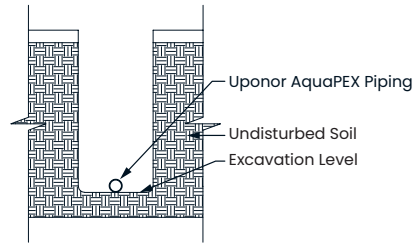

### Figure 5-2: Good Soil Conditions

If the trench is dug smoothly, install the piping directly on the prepared bottom. The bottom must be flat with no hollows, lumps or rocks.

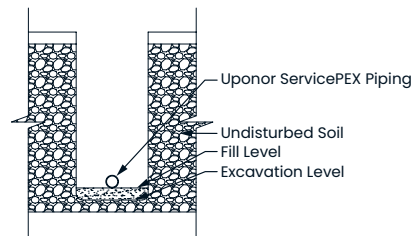

### Figure 5-3: Poor Soil Conditions

With rocky, clay, muddy, or other poor soil conditions, it may be necessary to prepare the trench bottom using granular material of such size and grading to provide a stable base. See local code for additional requirements.

## Piping Embedment

When embedding Uponor PEX piping, pressurize the piping prior to backfilling. Then, backfill using sand or gravel with a  $\frac{3}{4}$ " maximum particle size.

Compact the initial backfill for adequate piping support and to limit settling. Note that it is especially important to effectively compact the soil around the tap connection.

In heavy vehicular traffic areas, compact backfill to 90% of maximum soil density. Do not use highly plastic clays, silts, organic materials, or sharp or large rocks as backfill near the piping.

Compact the backfill from the subgrade to a level per local code that will cover the piping 4" to 6".

For additional information, refer to the AWWA C904 Standard for installation of Uponor PEX piping in underground water service applications.

## Installation

Install Uponor PEX piping underground in a manner that ensures external loads will not subsequently cause a decrease in the vertical dimension of the cross section of the piping that exceeds 5% of the O.D. Install Uponor PEX piping in a snaking pattern with sufficient slack in the line to allow for contraction of the line due to temperature change prior to backfilling.

Per PPI TR-21 Thermal Expansion and Contraction in Plastics Piping Systems, restrain a buried or concrete-encased pipe from both lateral and axial movement with surrounding embedment material. The magnitude of the frictional restraining force is dependent on the nature of the soil and on installation and operating conditions.

For example, the extent of compaction near the pipe can affect the quality of contact between the pipe and surrounding soil. The anchoring or restraining effect of surrounding soil on pipe movement can be significantly augmented by external pipe geometry. Tees, lateral connections, and changes in direction all help to anchor a pipe in the surrounding soil.

**Note:** Do not use blocking to support the piping or change the piping grade. Do not install Uponor PEX piping in, under, or above cesspools, septic tanks, septic-tank drainage fields, or pits.



**Caution:** Do not install Uponor PEX piping in soil environments contaminated with solvents, fuels, organic compounds, pesticides, or other detrimental materials that may cause permeation, corrosion, degradation, or structural failure of the piping. Where such conditions are suspected, perform a chemical analysis of

the soil or groundwater to ascertain the acceptability of Uponor PEX piping for the specific installation. Check local codes for additional requirements.

## Handling and Repairs

Although Uponor PEX piping is highly resistant to kinking and abrasion, it is important to handle with care while installing the piping to prevent damage and possible failure. If damage occurs during installation, cut out and repair the area before backfilling.

To reform kinked piping, refer to the reforming kinked piping section in **Appendix C**. If the piping is damaged beyond its thermal-memory capacity, use a ProPEX EP or LF brass coupling. Do not reuse or reclaim ProPEX EP or LF brass fittings.

**Note:** For horizontal directional drilling (HDD) applications, refer to the Uponor PEX Piping Systems Design and Installation Manual.

## Trace Wire

Uponor recommends the use of trace wire to facilitate in the detection of underground pipe systems. Trace wire should be 5 or 7 kWh, 14-gauge minimum solid copper with thermoplastic insulation suitable for direct burial. Refer to local code for further requirements.

## Compression Fittings

Use only SDR9 compression fittings listed in compliance with AWWA C800 as referenced in AWWA C904 for water service applications when transitioning from curb stops or corporation stops to Uponor PEX piping.

Be sure to use insert stiffeners when assembling a compression fitting with PEX. Commonly available SDR9 compression fitting manufacturers include:

- Ford Meter Box Company, Inc.\*
- Mueller Company\*
- A.Y. McDonald Mfg. Co.\*
- Philmac\*

## Water Service Disinfection

Uponor recommends flushing an Uponor PEX plumbing system with clean, potable water. When system disinfection is required, follow the Uponor Plumbing System Disinfection Guidelines.

**Important!** To prevent reduced service life of system components, disinfection solutions should not remain in the system longer than 24 hours. Use a chlorine solution of 50 parts per million (ppm) for 24 hours or 200 ppm for three hours for disinfection. Flush the system with potable water after disinfection.

## ProPEX Water Meter Fittings and Valves

Uponor offers ProPEX water meter fittings and valves designed for connecting  $\frac{3}{4}$ " and 1" pipe to  $\frac{5}{8}$ " to 1" water meters. The offering is available in both EP or LF brass and features NPSM swivel connections.



**Figure 5-4: ProPEX Water Meter Fittings**

## Expansion Tanks

In accordance with most major plumbing codes in North America, systems that include backflow preventers, pressure reducing valves (PRVs), or check valves on the main water service line will require an expansion tank or other approved device to control thermal expansion. Systems utilizing these devices are more likely to experience elevated pressures that may be above the maximum recommended limit of 80 psi. Note that excessive dynamic (rather than static) fluctuations within the plumbing systems' temperature and/or pressure can impact the

The system includes a mounting bracket which can accommodate "felt" type sound isolation wrapped around the fittings or valves to support the water meter system.

When installing the system, be sure to accommodate for the varying length of meters (typically between 7" to 9") with a proper length of "flow tube"



**Figure 5-5: ProPEX LF Brass Water Meter Valves**

long-term performance of the plumbing system components, including Uponor products. It is important to take extreme care to control these scenarios with proper design, installation, and equipment that can manage these effects. It is imperative to maintain and control both consistent and/or excessive temperature and pressure fluctuations above recommended system limits and/or code for the long-term health of the plumbing system. Refer to local code as well as the water heater manufacturer's installation guidelines for expansion tanks and other similar devices.



## Section 6

# Installation Methods

### Below-Grade or In-Slab Installations

Uponor PEX piping along with ProPEX EP and LF brass fittings are approved for installation below grade. For LF brass fittings, wrap with 4 to 6 mil poly or other suitable waterproof protection.

**Note:** Uponor non-LF brass fittings are not for potable applications and are not recommended for direct burial.

For convenience, Uponor offers a pre-sleeved piping product for these types of applications. For the complete product offering, refer to the Uponor Product Catalog.

Refer to the following instructions for below-grade or in-slab installations.

1. Always follow local code when installing Uponor PEX pipe below grade or in the slab, as some jurisdictions require additional sleeving and protection.
2. Protect piping where it enters and exits a concrete slab with 0.025" (0.064 mm) thick protective material, such as HDPE wrapping, PE tape, closed-cell pipe insulation, PVC elbows, and sleeves or equivalent, that allow expansion and contraction of the piping.
3. Lay the Uponor PEX pipe in a trench and backfill as needed with dirt to prevent the pipe from recoiling in the trench.
  - a. Ensure the soil provides stable and continuous support for the piping with no hollows, lumps, or rocks.
  - b. For poor soil conditions (e.g., rocky, clay, muddy, etc.), prepare the trench bottom with a granular material to provide a stable base.
  - c. Backfill with sand or gravel with a maximum particle size of  $\frac{3}{4}$ ". Do not use highly plastic clays, silts, organic materials, or sharp or large rocks as backfill.
  - d. Compact the backfill from the subgrade to a level per local code that will cover the piping 4" to 6" to provide protection around the piping.
  - e. Refer to local code for additional requirements.
4. Best practice is to install pipe in one long, continuous run. If a connection is necessary, use Uponor ProPEX EP fittings, which are approved for use in below-grade and in-slab applications. If using ProPEX LF brass fittings, cover the fitting with an overwrap of 4 to 6 mil poly or other suitable waterproof protection.

**Note:** Uponor recommends using a ProPEX EP coupling to repair piping damaged during a concrete pour. If a ProPEX EP coupling is not available, use a ProPEX LF brass coupling wrapped with a protective polyethylene sleeve to prevent

direct contact between the concrete and the brass coupling.

5. After installation, pressurize the system (typically 20 psi above working pressure) before backfilling or pouring the concrete.

---

## Installing Uponor AquaPEX Piping in Wood-Frame Construction

### Piping Runs

- Leave extra piping at the beginning and end of runs to simplify the connection to fittings and multiports.
- Ensure runs are as direct as possible between fittings and multiports and the fixtures they supply.
- Insulate hot- and cold-water piping runs where code requires or as necessary.
- Refer to **page 38** for bundling pipe requirements.
- For information about locations and techniques for drilling through load-bearing construction, consult your local building codes.



**Figure 6-1: Running Uponor AquaPEX Main Lines Through Open-Web Trusses**

- Use grommets when installing Uponor AquaPEX pipe in steel-stud applications.
- When installing in attics, refer to local code for insulation requirements.



**Figure 6-2: Recessed Light Fixture**

### Recessed Light Fixtures

There are two types of recessed lights: Type I.C. (insulation contact), which allows direct contact with thermal insulation, and Type Non-I.C. (non-insulation contact), that requires a 3" minimal clearance from thermal insulation.

Install Uponor AquaPEX a minimum of 2" away from Type I.C. fixtures and 12" away from Type Non-I.C. fixtures.

When it is necessary to install closer than 12" from a Type Non-I.C. fixture, follow these guidelines:

- If there is not enough room in the joist cavity to meet the 12" restriction, use insulation around the piping.
- Use only insulation rated to withstand the temperature generated by the fixture.
- Insulate all piping that is within 12" of the recessed light with closed-cell polyethylene,

polyolefin, or other suitable pipe insulation for a distance of 12" on either side of the light fixture.

- Insulation is required near UV light sources (including fluorescent bulbs); be sure to protect piping from direct UV exposure.



**Figure 6-3: Fluorescent Lights**

### Fluorescent Lighting

When installing Uponor AquaPEX within 6" of fluorescent lighting, insulate the pipe from heat exposure with closed-cell or fiberglass pipe insulation. Ensure the pipe is protected 18" beyond each side of the fluorescent light source and maintains a minimum clearance of 1" from the fluorescent light source.

When pipe is directly under or within 3 feet laterally of fluorescent lighting, sleeve the pipe with HDPE poly sheathing, closed-cell pipe insulation, or any suitable pipe covering material that is black in color to protect it from UV exposure. Ensure the coverage extends 18" beyond each side of the fluorescent light source.

## LED Lighting

If installing Uponor AquaPEX within 18" of an LED light source, cover the pipe with foam insulation or some other protective covering. Such protection should cover the pipe to a distance of at least 18" from the light source.

## Piping Supports: General Guidelines

- Uponor recommends using plastic or metal piping supports designed for use with plastic piping.
- Do not use supports that will damage the piping. Inspect metal supports for sharp edges.
- Allow for the linear expansion rate of Uponor AquaPEX piping – Approximately 1.1" (27.9 mm) per 10°F (5.6°C) temperature change for every 100 ft. of piping.
  - When installing piping runs, thermal expansion calls for an extra  $\frac{1}{8}$ " to  $\frac{3}{16}$ " of longitudinal clearance per foot of run. Do not allow piping to dip excessively between supports. Do not pull piping tight during installation.
- Allow adequate clearance between PEX piping and the structure (bored holes or sleeves) to allow piping to move freely due to thermal expansion and contraction.

## Piping Supports: Horizontal Runs

Support piping in accordance with **Table 6-1**. If continuously supporting horizontal runs (i.e., truss-to-truss spacing is 32" or less), place pipe supports on every other support member (truss).

Follow local code requirements when installing PEX piping in fire-resistant construction floors, ceilings, or walls.

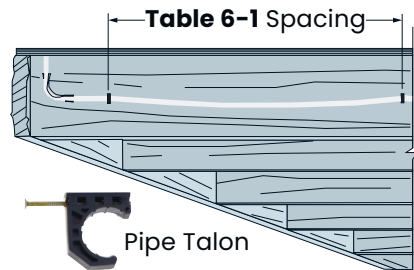

**Figure 6-4: Pipe Talons for Horizontal Runs**

Nominal Pipe Size	Maximum Horizontal Support Spacing		Maximum Vertical Support Spacing		
	IPC/IMC/UPC/UMC	National Plumbing Code of Canada	IPC/IMC	UPC/UMC	National Plumbing Code of Canada
PEX Pipe 1" and Smaller	32 inches	30 inches	10 feet <sup>1</sup>	Base and each floor; provide mid-story guides	Support at the base and at the floor of alternate stories; not to exceed 7.5 m <sup>2</sup>
PEX Pipe 1½" and Larger	4 feet				

**Table 6-1: Support Requirements for Crosslinked Polyethylene (PEX) Pipe by Code**

<sup>1</sup> For sizes 2 inch and smaller, a guide shall be installed midway between required vertical supports. Such guide shall prevent pipe movement in a direction perpendicular to the axis of the pipe.

<sup>2</sup> Although not required by the National Plumbing Code of Canada, Uponor recommends the use of vertical supports at five feet for sizes 2 inch and smaller to minimize pipe movement.

### Piping Supports: Vertical In-Wall Piping

Reference **Table 6-1** for vertical support spacing.

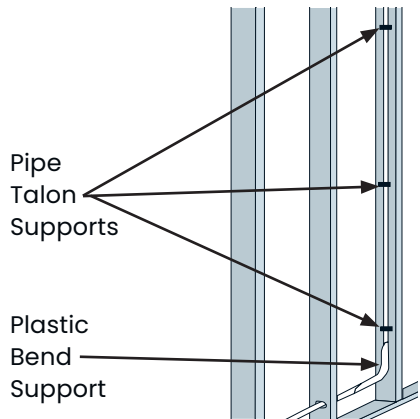

**Figure 6-5: Plastic Bend Support**

### Strapping

Approved strapping materials for bare Uponor AquaPEX include:

- Pipe talons
- Clamps
- Stand-off brackets
- Nylon banding and cable ties (60 lb. minimum) suited for the application temperature
- Ensure steel straps are coated or have no sharp edges.



**Figure 6-6: Pipe Talons and Plastic Bend Support for Vertical Runs**

- Do not use cable ties for suspension alone.
- Use insulation or stand-off brackets to isolate piping from other mechanical, electrical, and plumbing (MEP) systems.

## Bundling

Parallel runs of Uponor AquaPEX may be bundled together given the following guidelines:

- Support the entire bundle at the required O.C. distances.
- Use cable ties to maintain a tight bundle of Uponor AquaPEX.
- Do not use cable ties as the sole means of supporting the bundle.
- Do not use wire ties, metal strapping, or duct tape for bundling.
- Keep hot and cold bundles 6" apart if uninsulated.
- There is no restriction on the number of lines bundled.

## Spray-Foam Insulation

Uponor approves the use of spray-foam insulation directly on its PEX pipe and ProPEX LF brass fittings. However, ProPEX EP fittings require an overwrap of 4 to 6 mil poly or other suitable waterproof protection.

### Closed-Cell Spray Foam Insulation

When using closed-cell spray foams, ensure the maximum temperature of 250°F/121.1°C is not exceeded during the foam-setting process. To help insulate the pipe from heat during the



**Figure 6-7: Bundled Uponor AquaPEX Pipe**

spray-foam process, place a light initial layer of spray foam over the PEX piping prior to spraying the entire area.

**Table 6-2** shows temperatures relating to the foam depth of lift.

Depth of Lift	Temperature
1"	130°F/54.4°C
2"	200°F/93.3°C
3"	320°F/160°C

**Table 6-2: Closed-Cell Spray Foam Temperatures in Relation to Depth of Lift**

If the job requires more than 2" of lift, Uponor recommends using a two-lift application: Apply the first layer, 2" or less. Wait 15 minutes (the time required for the heat from a 2" lift to dissipate). Then, apply the second layer.

### **Icynene® Spray-Foam Insulation**

Icynene® Classic (LD-C-50™), Classic Max™ (LD-C-50-V2), and MD-C-200™ spray-foam insulation is compatible with Uponor AquaPEX pipe and ProPEX fittings.

Ensure the insulation is installed by an Icynene-licensed dealer and factory-trained installer. For further information, refer to the Icynene installer's manual.

### **Uponor Logic Plumbing System**

The Uponor Logic plumbing system is an organized arrangement of Uponor AquaPEX piping, EP multiport tees, ProPEX fittings, and out-of-the-wall systems offering rapid hot water delivery with superior flow characteristics.

For the installer, Uponor Logic minimizes the number of required fittings and connections by way of remote multiport tees, creating a water distribution system that is more efficient to install, reducing liability, and increasing profitability.

Multiport tees are available in both flow-through and branch configurations and do not require access. Refer to **Appendix A** for detailed Uponor Logic layout instructions.

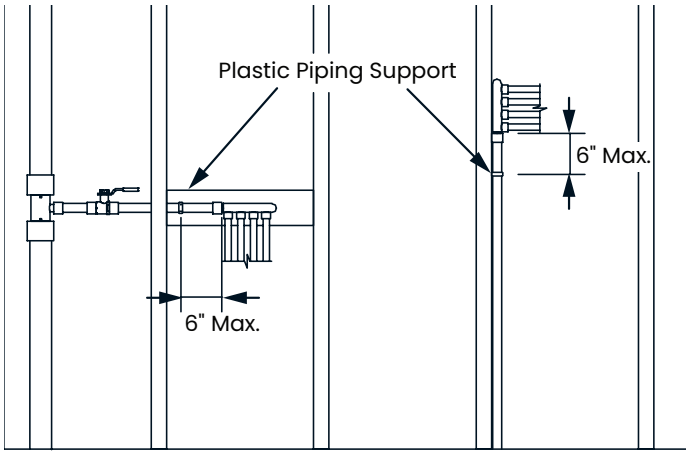

**Figure 6-8: ProPEX EP Multiport Tees**

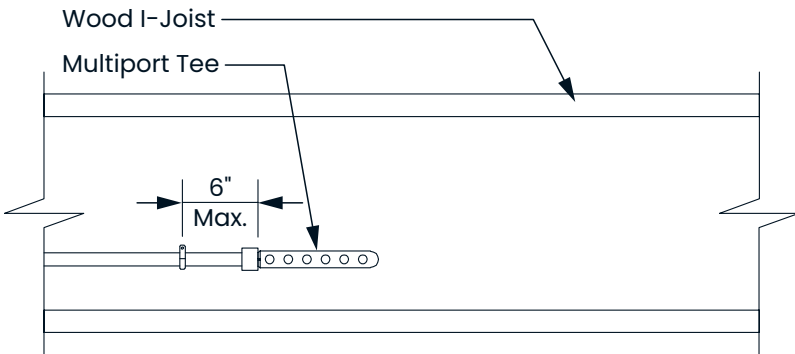

**Figure 6-9: Multiport Tee Installation**

## Supporting Uponor Multiport Tees



**Figure 6-10: In-Wall Supports for Multiport Tees**



**Figure 6-11: Supporting Multiport Tees on Wood I-Joists**

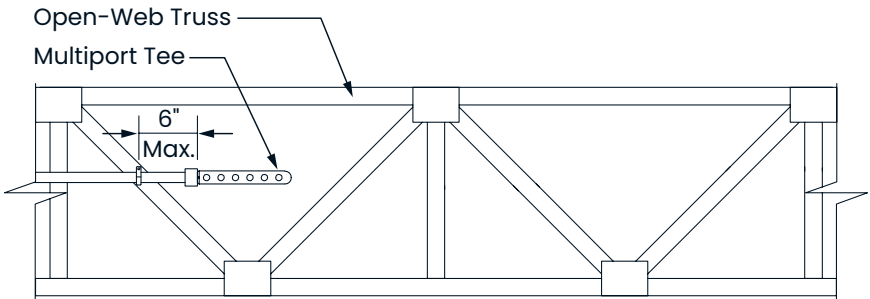

**Figure 6-12: Supporting Multiport Tees on Open-Web Wood Trusses**



## ProPEX Out-of-the-Wall Support System

The ProPEX out-of-the-wall support system is a complete, easily installed system that makes exiting the wall with PEX easier than ever.

The system includes:

- PEX wall support bracket with alternating  $\frac{1}{2}$ " and  $\frac{3}{4}$ " holes
- $\frac{1}{2}$ " plastic bend support
- ProPEX escutcheon in chrome or white finish for  $\frac{1}{2}$ " PEX piping
- The plastic bend support snaps into the mating wall support bracket, providing rigid support from all angles.
- The escutcheon allows you to make a ProPEX connection inside the sleeve and fully concealed.

### Installation Example

1. Feed the Uponor AquaPEX piping through the wall opening (see **Figure 6-13**).
2. Measure 2" to  $2\frac{3}{16}$ " from the wall and mark the piping.

**Note:** If you cut the piping at  $2\frac{3}{16}$ ", this will allow enough length for additional adjustments, but may require re-cutting.

3. Square cut the piping after measuring for the desired cut location.
4. Slide the ProPEX escutcheon towards exposed piping. Then slide the flared sleeve over the exposed piping and position the escutcheon against the wall.
5. Slide on the ProPEX ring until it hits the stop edge.
6. Ensure that you have properly aligned all components. If necessary, remove the escutcheon and sleeve; then re-cut the piping to the appropriate length.
7. Expand the ProPEX ring and piping according to instructions.
8. Fully insert the stop valve into the expanded piping until the ring hits the stop of the valve.

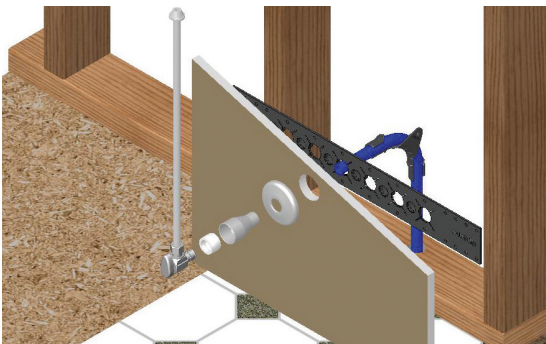

**Figure 6-13: Installation Example of ProPEX Out-of-the-Wall Support System**

## ProPEX Drop Ear LF Brass Elbows

The ProPEX drop ear LF brass elbow provides a rigid 90-degree bend and the ability to secure  $\frac{3}{8}$ " to 1" Uponor AquaPEX piping where it exits a wall.



**Figure 6-14: ProPEX Drop Ear LF Brass Elbow**

## Metal Straight-Through Supports

Uponor straight-through supports provide rigid support and the ability to secure Uponor AquaPEX piping as it exits a wood floor.



**Figure 6-15: Straight-Through Support**

## Grommets

Use grommets suitable for steel-stud applications when installing Uponor AquaPEX pipe through steel framing. Grommets are not required for wood-frame applications.

## Water Hammer Arrestors

Uponor AquaPEX piping withstands repeated pressure surges well beyond its rated pressure capacity.

- Uponor AquaPEX piping minimizes surge pressure (40% less than rigid pipes).
- Water hammer arrestors are only necessary if local code requires them.

## Steel Plate Protectors

The Steel Plate Protector (F5700002) protects installed piping from possible damage (e.g., if piping is in danger of damage by drywall, paneling, trim screws, or nails).

- Use these protectors to safeguard the pipe during and after construction.
- If installing Uponor AquaPEX piping through hollow masonry walls or metal studs, always protect with suitable sleeves or grommets.

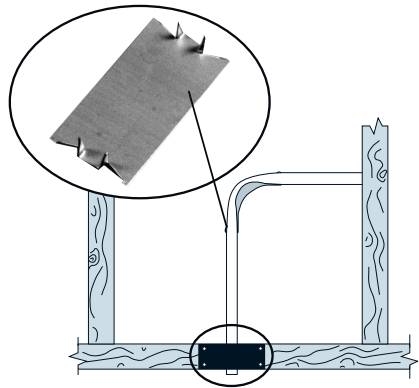
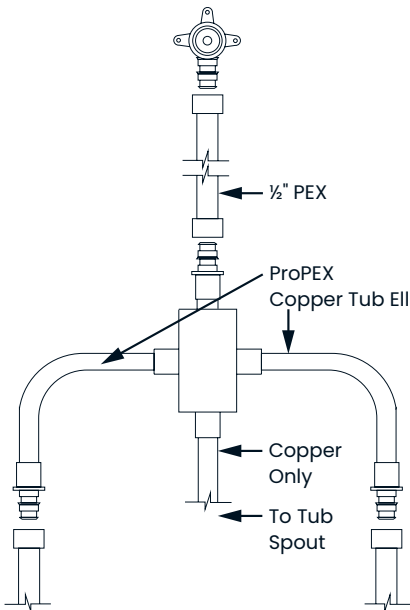

**Figure 6-16: Steel Plate Protectors**

## Shower Valve Connections

Uponor AquaPEX piping is suitable for hot and cold inlets on the shower valve, as well as the supply to the showerhead. Refer to **Figure 6-17** for an illustration of valve connections.

**Note:** Numerous manufacturers offer valves with ASTM F1960 connections. A ProPEX fitting sweat or press adapter is still required to use Uponor AquaPEX for the shower head supply.



**Figure 6-17: Valve Connection Example**

## Hose Bibs

- Connect Uponor AquaPEX via ProPEX threaded, sweat or press adapters, or other manufacturers' hose bibs with ASTM F1960 connections.
- Rigidly anchor the hose bib to prevent it from loosening.

## ProPEX Copper Tub Ells

ProPEX copper tub ells provide a 90-degree transition from tub and shower valves to Uponor AquaPEX piping.

For the complete product offering, refer to the Uponor Product Catalog.

**Caution:** Do not use Uponor AquaPEX piping to connect the tub and shower valve to the tub downspout as this may create excessive back pressure in the valve, causing it to remain slightly open.



**Figure 6-18: Tub Ell**

## ProPEX Copper Stub Ells

ProPEX copper stub ells provide a 90-degree transition from Uponor AquaPEX piping to copper.

Use a ProPEX copper stub ell at the fixture to exit from the wall instead of using a drop-ear bend support.

For the complete product offering, refer to the Uponor Product Catalog.



**Figure 6-19: Stub Ell**

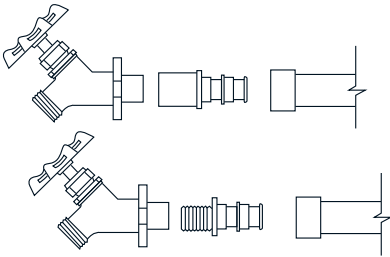

**Figure 6-20: Standard Hose Bibs**

## Straight and Angle Stop Valves

Uponor offers ProPEX LF brass straight and angle stop valves as well as chrome-plated LF brass compression straight and angle stop valves for point of use at the fixture.



**Figure 6-21: ProPEX LF Brass Straight and Angle Stop Valves**

ProPEX straight and angle stop valves feature an ASTM F1960 connection for 1/2" Uponor AquaPEX pipe and a 3/8" male threaded connection for fixture risers.

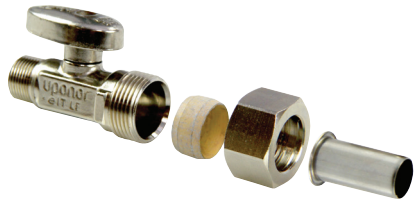

**Figure 6-22: Chrome-Plated LF Brass Compression Stop Valves**

Compression straight and angle stop valves include a Teflon®-coated brass compression ring and a stainless-steel insert for compression connection to 1/2" Uponor AquaPEX pipe and a 3/8" male threaded connection for fixture risers.

**Note:** Use Uponor 3/8" OD Compression Nut and Nylon Sleeve (part number F5440380) for rigid pipe fixture connections.



**Figure 6-23: 3/8" OD Compression Nuts and Nylon Sleeves**

## Installing Compression Connections

1. Square cut the piping perpendicular to the piping length.
2. Place the nut and then the compression ring over the end of the piping.
3. Use the brass compression ring included with the stop valve.
4. Install the brass or stainless steel insert into the piping end. Be sure to set the insert completely against the end of the piping.
5. Slowly tighten the compression nut to the opposing thread.

**Note:** Retighten all compression fittings after initial installation.

6. Wait 30 minutes to allow the piping to relax, and then retighten each fitting.

## Termiticide or Pesticide Treatment

Uponor AquaPEX piping is often installed in soil that is treated with liquid termiticides/pesticides categorized into two types: organic solvent-based (also known as petroleum solvent-based) and water-based (water solvent-based).

Organic-based termiticides/pesticides have largely disappeared from the North American marketplace for this application, and the majority of products available today are water-based. Water-based products are generally safer for the environment and pose less risk of infiltration into Uponor AquaPEX piping.

Although all research data and anecdotal evidence strongly suggest that there are no permeation issues with water-based termiticides/pesticides and PEX, caution is required to ensure safe installation of Uponor AquaPEX piping and to prevent misapplication of the liquid termiticides/pesticides, especially to prevent pooling or puddling of these chemicals around Uponor AquaPEX piping.



**Caution:** The misapplication of termiticides or pesticides between Uponor AquaPEX piping and slab penetration protection devices could result in pooling or puddling of the products around the piping, a prohibited practice. The application of pesticides or termiticides between Uponor AquaPEX piping and slab penetration protection devices is strictly prohibited.



## Section 7

# Pressure Testing and Water System Disinfection

### Pressure Testing

Pressure test the system with water, air, or a mixture of both in accordance with local code requirements. The recommended test pressure is at least 20 psi above working pressure or 100 psi (not to exceed 120 psi). Slight fluctuations of pressure are normal due to ambient temperature changes.

**Note:** Higher test pressures can cause a slight radial expansion of the piping and a subsequent relaxation of the material, resulting in a reduction of test pressure. This is normal and does not indicate a leak.



**Caution:** If using water to pressure test the system, purge all water from the system prior to the ambient air temperatures falling to 32°F (0°C). Failing to remove the water from the system can result in damage to the piping and associated equipment.

**Note:** When pressure testing in multifamily applications, refer to the Uponor PEX Piping Systems Design and Installation Manual or the Uponor PEX Piping Systems Installation Guide for detailed instructions.

### Water System Disinfection

When required, disinfect Uponor AquaPEX pipe and fittings in accordance with Uponor AquaPEX Plumbing System Disinfection Guidelines.

**Important!** To prevent reduced service life of system components, disinfection solutions should not remain in the system for longer than 24 hours. Flush the system with potable water after the disinfection process is completed.





## Appendix A

# Laying Out an Uponor Logic System

### Uponor Logic Plumbing Systems vs. Conventional Thinking

Uponor Logic is an organized arrangement of flexible PEX pipe, innovative multiport tees, and out-of-the-wall support systems to provide a water distribution system that is more efficient to install, limits liability with fewer fittings and connections, and offers rapid hot-water delivery with superior flow characteristics.

#### Features and Benefits

- Efficient use of time and materials
- Fewer connections limits liability
- Fast hot-water delivery potential
- Full line of multiport tees for ultimate design flexibility

In a Logic layout, a main line connects to a multiport tee with distribution lines going out from the tee. These individual

lines extending from the single multiport tee provide water to all fixtures in a single or adjacent grouping.

This design uses significantly less pipe than a home-run layout, with just a few more connections. Plus, it requires considerably fewer connections compared to a trunk-and-branch installation.

For example, a 2,300-square-foot, two-story home using a Logic design requires only 637 feet of pipe while a home-run system uses 1,515 feet. Logic also installs much faster compared to a trunk-and-branch system due to the vast reduction in connections. With the two-story home, a Logic layout uses only 16 fittings and 59 connections compared to 96 fittings and 165 connections for trunk and branch.

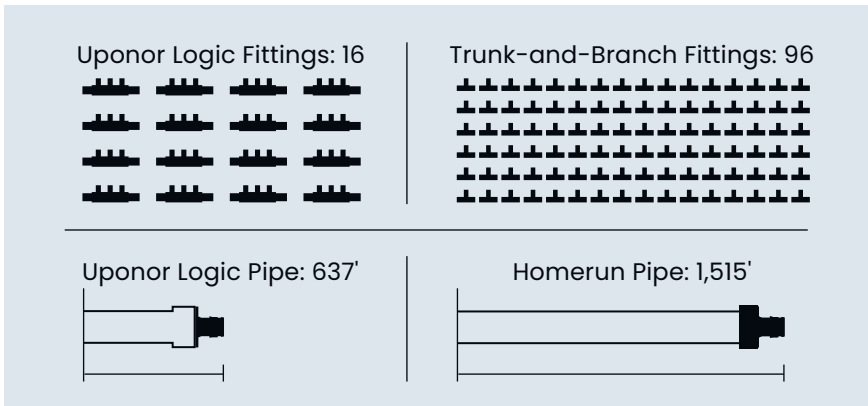
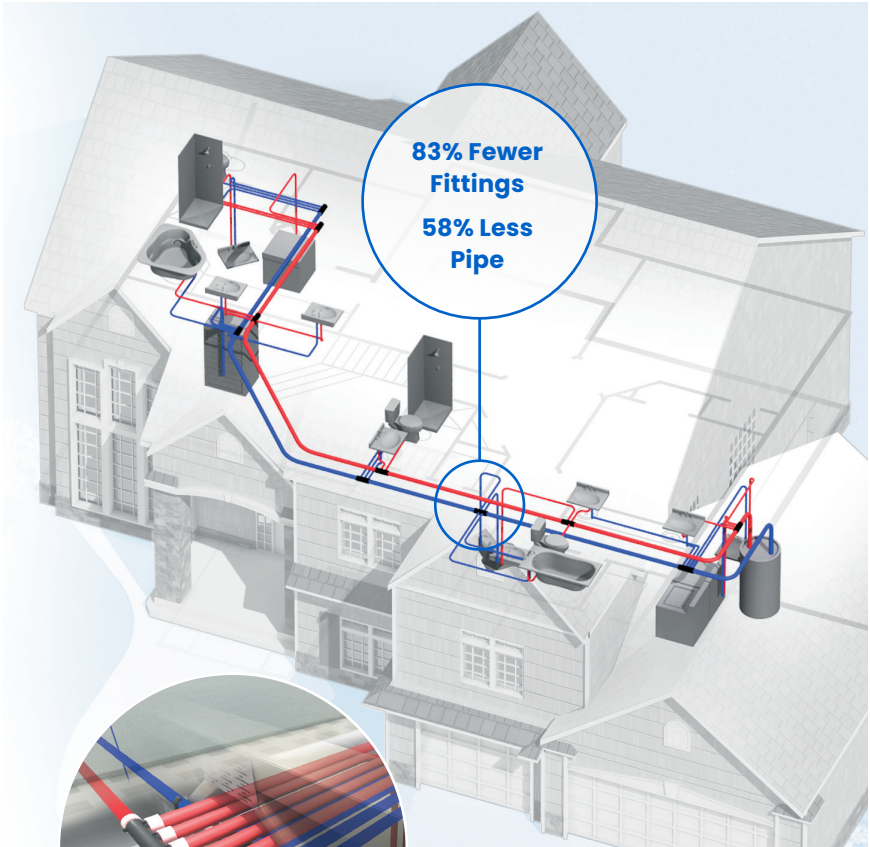

Figure A-1: Fitting and Pipe Usage Comparison

# Uponor Logic Plumbing



## The Optimal Design Approach

- > Minimal connections
- > Minimal use of pipe
- > Quick delivery of hot water
  - 637' Uponor AquaPEX pipe
  - 59 ProPEX connections
  - 16 fittings

**Figure A-2: Uponor Logic Plumbing Diagram**

## Trunk-and-Branch Plumbing

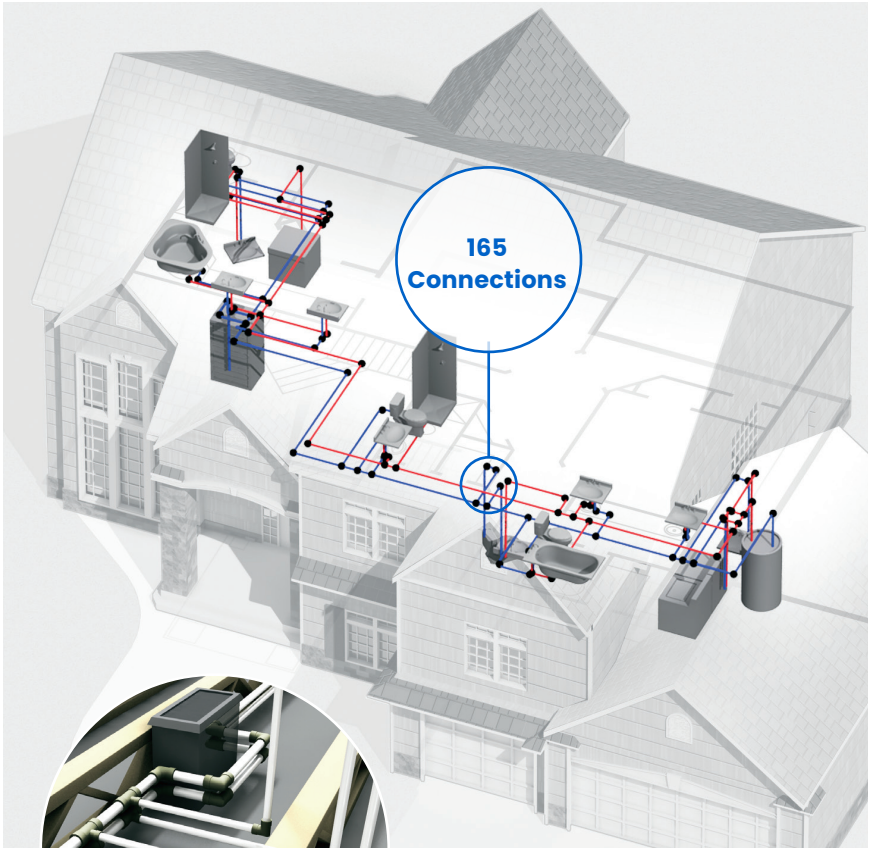

- > Many connections
- > More time to install
- > Higher potential for leaks
- > Dry-fit concerns
  - 540' pipe (copper, CPVC, PEX)
  - 165 connections
  - 96 fittings

**Figure A-3: Trunk-and-Branch Plumbing Diagram**

# Homerun Plumbing

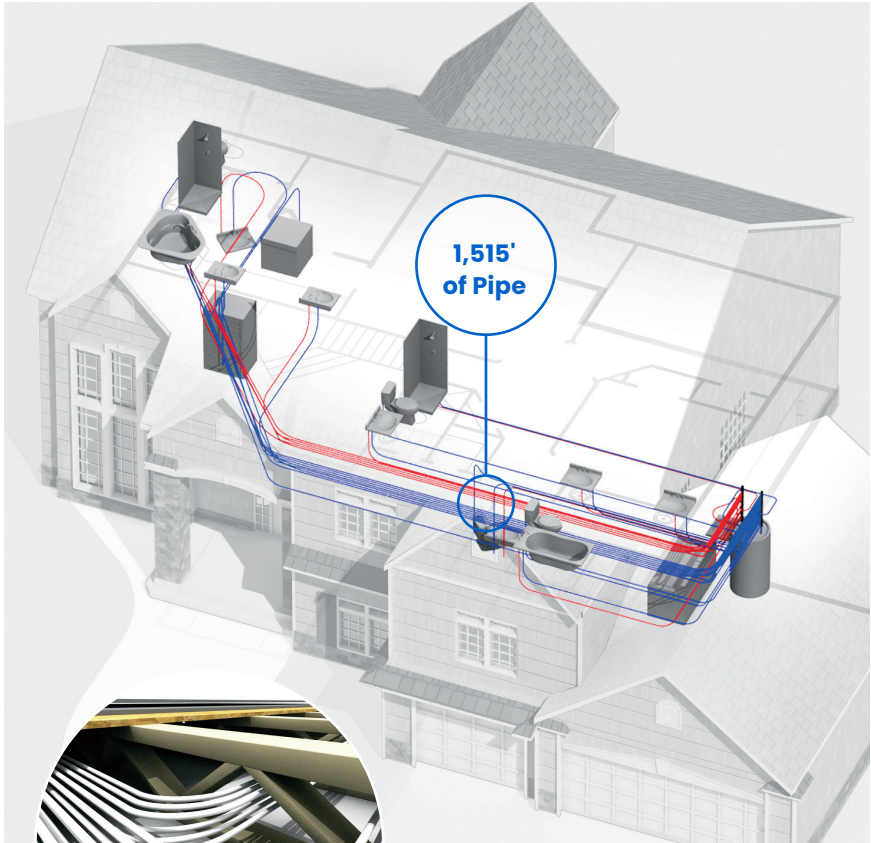

- > Minimal connections
- > Inefficient use of pipe
- > No consecutive-use hot water delivery benefit
  - 1,515' pipe
  - 48 connections
  - 10 fittings

**Figure A-4: Homerun Plumbing Diagram**

## Two-Story Home: Planning Example

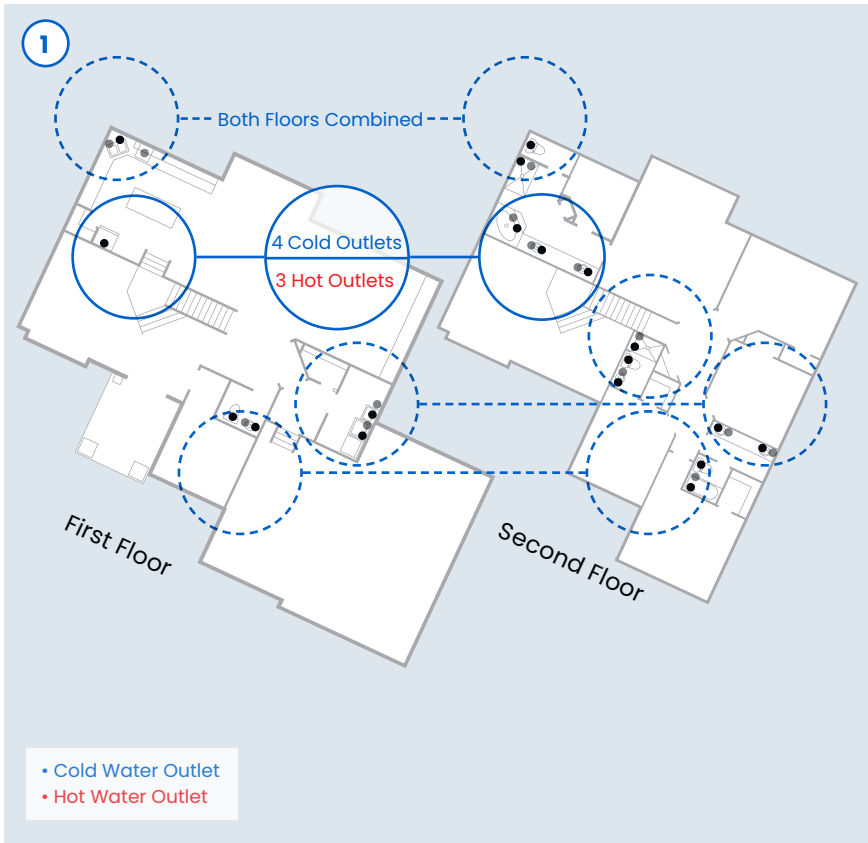

### Step 1: Uponor Logic

- Identify location of all plumbing outlets.
- Identify fixture groupings within approximately 10-ft. radius on both floors.

**Figure A-5: Step 1 – Uponor Logic in a Two-Story Home is a Simple, Three-Step Process.**

## Two-Story Home: Planning Example

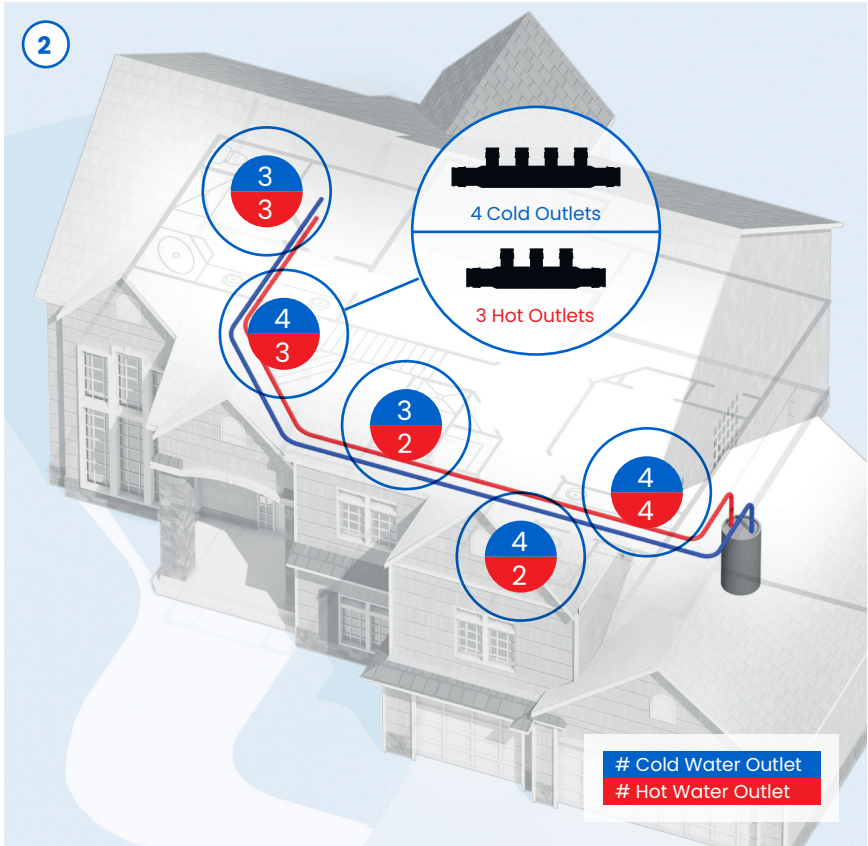

### Step 2: Uponor Logic

- Plan path through the house to connect fixture groupings.
- Identify number of hot and cold outlets for each grouping.



Master Bathroom/Kitchen



Bathroom B/  
Guest Bathroom



Master Bathroom/Ice Maker



Bathroom B/Laundry



Bathroom A

**Figure A-6: Step 2 – Uponor Logic in a Two-Story Home**

## Two-Story Home: Planning Example

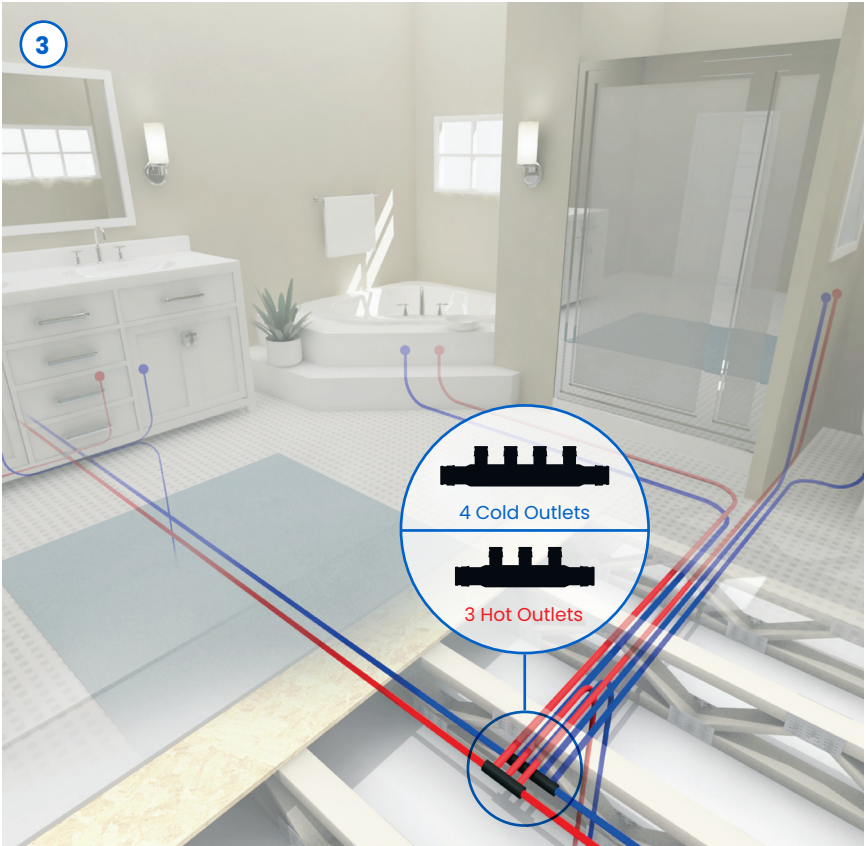

### Step 3: Uponor Logic

- Identify appropriate location of multiport tee for each grouping.
- Select appropriate multiport tee and fittings.

Figure A-7: Step 3 – Uponor Logic in a Two-Story Home

## Two-Story Home: Planning Example

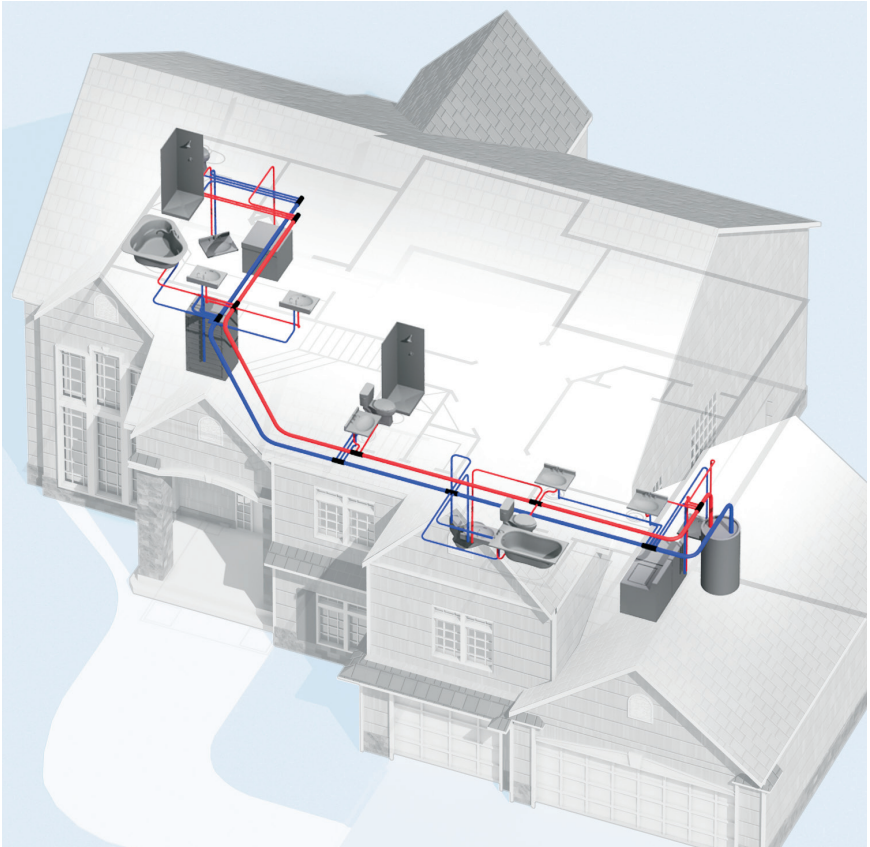

### Total Components for Uponor Logic Project

Q2227557  (2)

Q2247557  (4)

Q2237557  (2)

Q2237550  (2)

**Figure A-8: Total Components for Uponor Logic in a Two-Story Home**



## Slab-on-Grade Home: Planning Example

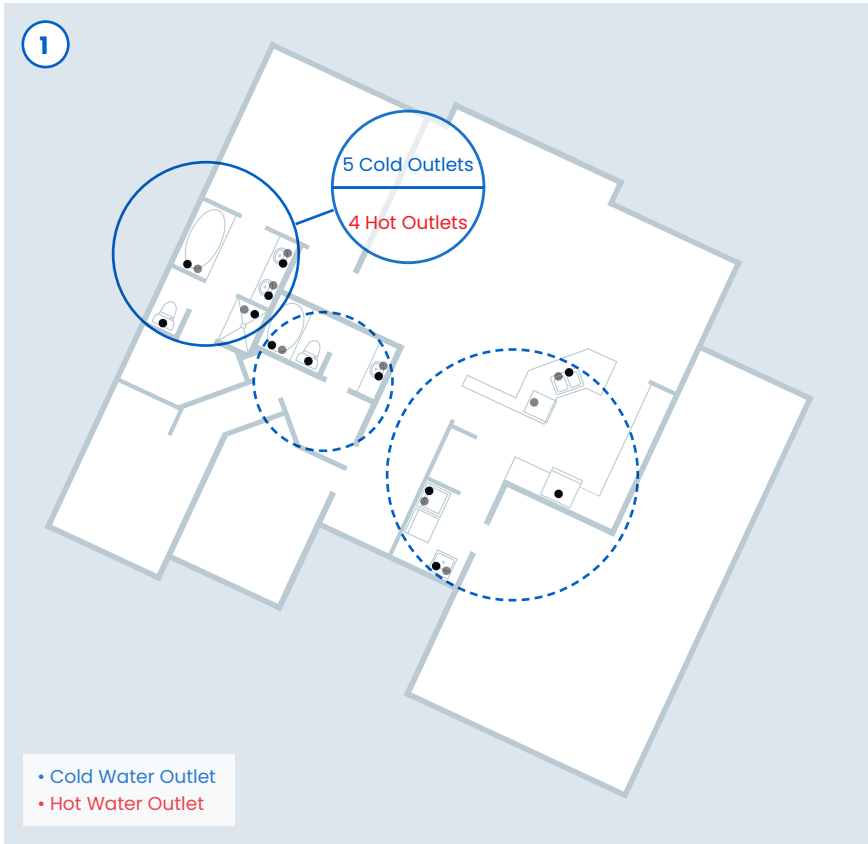

### Step 1: Uponor Logic

- Identify location of all plumbing outlets.
- Identify fixture groupings within an approximate 10-ft. radius.

**Figure A-9: Step 1 – Uponor Logic in a Slab-on-Grade Home is a Simple, Three-Step Process.**

## Slab-on-Grade Home: Planning Example

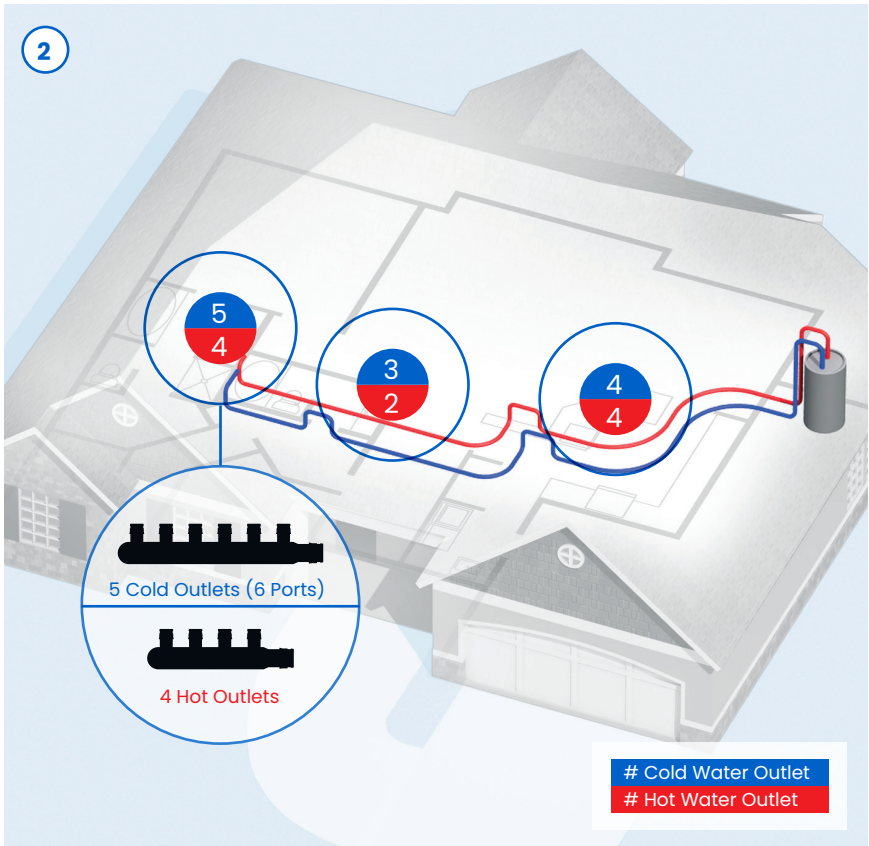

### Step 2: Uponor Logic

- Plan path through the house to connect fixture groupings.
- Identify number of outlets for each grouping.



Master Bathroom



Bathroom



Kitchen/Laundry

Figure A-10: Step 2 – Uponor Logic in a Slab-on-Grade Home

## Slab-on-Grade Home: Planning Example

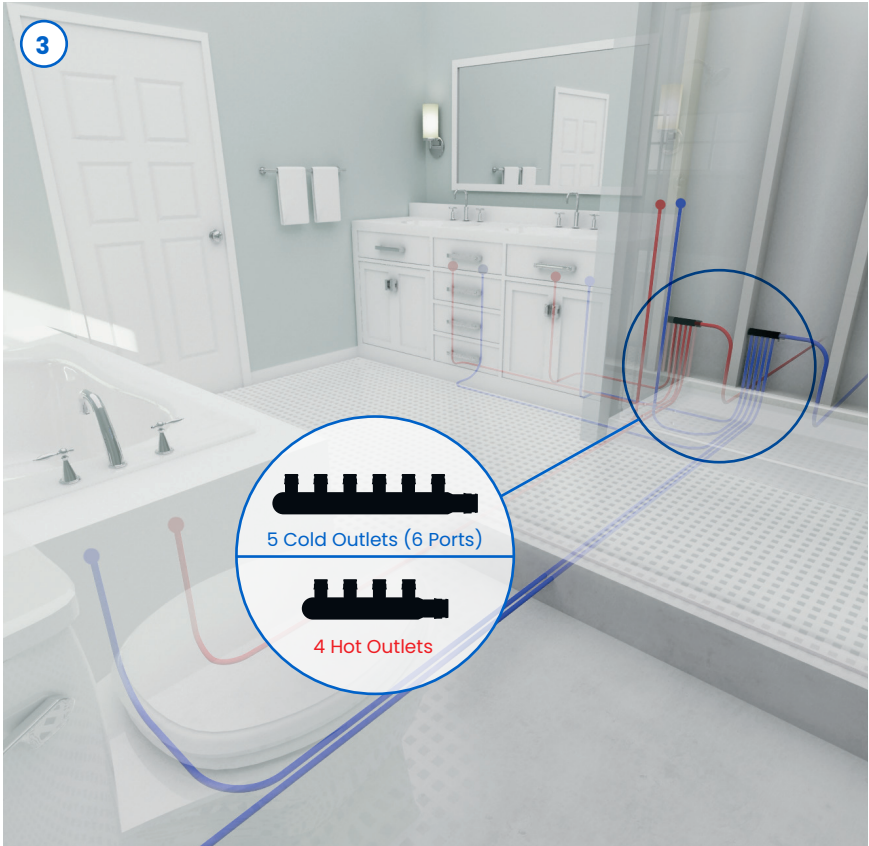

### Step 3: Uponor Logic

- Identify appropriate location of multiport tee for each grouping.
- Select appropriate multiport tee and fittings.

Figure A-11: Step 3 – Uponor Logic in a Slab-on-Grade Home

## Slab-on-Grade Home: Planning Example

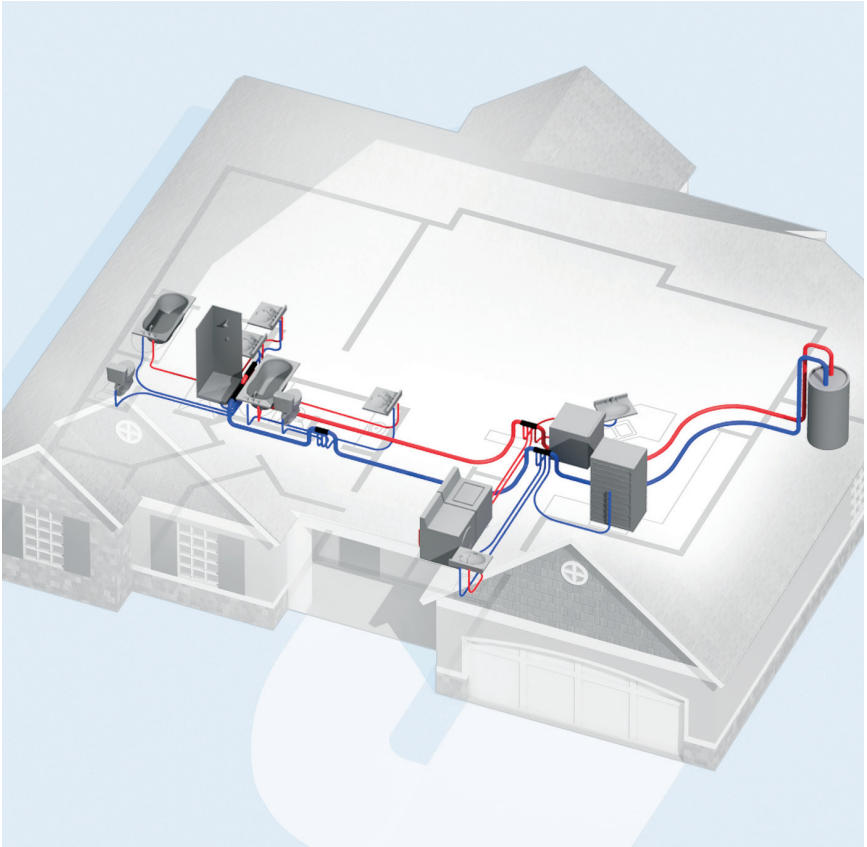

### Total Components for Uponor Logic Project

Q2227557  (1)    Q2247557  (2)    Q2267550  (1)  
Q2237557  (1)    Q2247550  (1)

**Figure A-12: Total Components for a Slab-on-Grade Home**

## Appendix B

### Standards, Listings, and Codes

#### Standards

Uponor PEX piping is manufactured to meet the following requirements. Refer to product submittals for details.

Standard	Specification
ASTM F876	Standard specification for cross-linked polyethylene (PEX) piping
ASTM F877	Standard specification for cross-linked polyethylene (PEX) plastic hot- and cold-water distribution systems
ASTM F1960	Standard specification for cold expansion fittings with PEX reinforcing rings for use with cross-linked polyethylene (PEX) piping
ASTM F2023	Standard test method for evaluating the oxidative resistance of cross-linked polyethylene (PEX) piping and systems to hot chlorinated water
ASTM F2657	Standard test method for outdoor weathering exposure of cross-linked polyethylene (PEX) piping
ASTM E84	Standard test method for surface burning characteristics of building materials
ASTM E119	Standard test methods for fire tests of building construction and materials
ASTM E814	Standard test method for fire tests of through-penetration firestop systems
AWWA C904*	Crosslinked Polyethylene (PEX) Pressure Tubing, ½" (13 mm) through 3" (76 mm), for Water Service
CAN/CSA B137.5	Crosslinked polyethylene (PEX) piping systems for pressure applications
CAN/CSA B214	Installation code for hydronic heating systems
CAN/ULC-S102.2	Standard method of test for surface burning characteristics of flooring, floor covering, and miscellaneous materials and assemblies
CAN/ULC-S101	Standard methods of fire endurance tests of building; construction and materials
CAN/ULC-S115	Standard method of fire tests of firestop systems
CAN/ULC/ORD-C199P	Combustible piping for sprinkler systems

Standard	Specification
ANSI/NSF Standard 14	Plastics piping system components and related materials
ANSI/NSF Standard 61	Drinking water system components — health effects
ANSI/NSF 359	Valves for crosslinked polyethylene (PEX) water distribution tubing systems
ANSI/UL 263	Standard for safety for fire tests of building construction and materials
UL 1821**	Standard for safety for thermoplastic sprinkler pipe and fittings for fire protection service (NFPA 13D applications only)
UL 2846	Standard for fire test of plastic water distribution plumbing pipe for visible flame and smoke characteristics

**Table B-1: Standards**

\*Uponor ServicePEX pipe only

\*\*Uponor AquaPEX White pipe and ProPEX fittings in sizes ¾" to 1¼" only

**Note:** Uponor ServicePEX is certified to the AWWA C904 Standard for installation in water service applications.

### Listings

- cNSFus-fs
- cNSFus-rfh
- cNSFus-pw
- cQAlus
- CSA
- PPI-TR-4
- ICC-ES PMG
- IAPMO
- BMEC
- CCMC

**Note:** Obtain listings at:

[www.qai.org](http://www.qai.org)  
[www.nsf.org](http://www.nsf.org)

### Codes

- ICC
- IPC
- IMC
- IRC
- UPC
- UMC
- NSPC
- HUD
- UFGS
- NPC of Canada
- NBC of Canada

**Note:** Check with your local Uponor representative for code compliance in your area.

### Material Designation Code

Uponor AquaPEX White, White with Red Print, and White with Blue Print have a material designation code of PEX 5106. Uponor AquaPEX Red and Blue piping as well as Uponor ServicePEX piping have a material designation code of PEX 5306. Material designation codes are tested in accordance with and defined by ASTM F876. The following page explains each digit in the code.

## First Digit

The first digit in the material designation code is for chlorine resistance tested in accordance with ASTM F2023. A digit 5 indicates the PEX piping has been tested and meets the requirements for minimum chlorine resistance at end-use conditions 100% of the time at 140°F (60°C). A 5 digit is the highest classification for chlorine resistance.

## Second Digit

The second digit is for demonstrated UV resistance of PEX material when tested in accordance with ASTM F2657. A digit of 1 indicates the PEX piping has a UV resistance of one month; a digit of 2 has a UV resistance of three months; a digit of 3 has a UV resistance of six months.

**Note:** Uponor ServicePEX pipe features a PEX 5306 marking for six months of UV resistance. However, the pipe has been **tested** and **proven** to withstand **12 months of UV exposure**.



## Third and Fourth Digits

The third and fourth digits are for hydrostatic design stress (HDS) as tested in accordance with the PPI Technical Report TR-4. The digits of 06 indicate the PEX piping has an HDS of 73°F (23°C) at 630 psi (43 bar).

## Piping Identification

The labeling (print line) on Uponor PEX piping provides several identifications.

For example, ½" Uponor AquaPEX white piping reads as follows:

UPONOR AquaPEX® PEX 5106  
½ IN UB04130415 SDR9  B137.5  
POTABLE cNSFus-pw 



U.P. Code CCMC 13529-R  
(ASTM F876/F877/F2023)  
(ASTM F1960/F2080) cWHIus  
FS25/SD50 WITH 1/2IN FG  
INSULATION ICC ESR-1099  
ANSI/AWWA C904

cQAIus P321 ULC/ORD-C199P  
IAPMO UES 0253 ASTM E84  
and CAN/ULC-S102.2 HUD  
MRI269d/160PSI 73.4°F/100PSI  
180°F/80PSI 200°F

UPONOR-PEX-α TUBING  
\*UB04130415 \*\*xxxxx

## Print Stream Identification

Print Stream on Piping	Explanation
UPONOR AquaPEX®	Brand name
PEX 5106	ASTM F2023 and ASTM F2657 I/A/W ASTM F876
½ IN	Pipe size (i.e., ½")
UB04130415	Manufacturing Code to Audit Material Source (USA, material type, extruder no., year, month, day)

<b>Print Stream on Piping</b>	<b>Explanation</b>
SDR9	Standard dimension ratio of 9
 B137.5 POTABLE	Potable water listing by CSA
cNSFus-pw	Potable water listing by NSF
	Listings by UL
U.P. Code	Uniform plumbing code marking
CCMC 13529-R	Canadian Construction Materials Centre Evaluation Report 13529-R
ASTM F876/F877/F2023	ASTM pipe standards
ASTM F1960/F2080/ F1807/F2098	ASTM fitting standards
cWHIus FS25/SD50	Warnock Hersey Listing for 25/50 FS/SD plenum rating
ICC-ES-PMG 1006	ICC evaluation services plumbing, mechanical, and fuel gas 1006
ANSI/AWWA C904*	American Water Works Association Standard for Water Service
cQAIus P321	QAI listing for 25/50 FS/SD plenum rating
130PSI 120°F UL 1821	UL standard for NFPA 13D fire protection service
ULC/ORD-C199P	ULC standard for combustible sprinkler piping
IAPMO UES 0253	IAPMO evaluation services report ER-0253
ASTM E84	Standard test method for surface burning characteristics - U.S.
CAN/ULC-S102.2	Standard test method for surface burning characteristics - CA
HUD MRI269e	HUD Material Release Report 1269e
160PSI 73.4°F/ 100PSI 180°F/80PSI 200°F	Hydrostatic ratings from PPI I/A/W ASTM F876
UPONOR-PEX-a TUBING	Type of crosslinking (PEX-a)
xxxxxx	Footage marker in increments of 5 ft.

**Table B-2: Print Stream Identification**

\*Uponor ServicePEX pipe only



## Appendix C

### Troubleshooting Tips and Tricks

#### Reforming Kinked Piping

If the piping is kinked and hinders flow, refer to the following instructions for repairs.

1. Make sure the system is not pressurized.
2. Straighten the kinked portion of the piping.
3. Heat the kinked area with an electric heat gun (approximately 450 watts of power). When using the heat gun, move it around to ensure an even distribution of heat until the piping returns to its original size and shape.

**Do not use an open flame.**

4. Let the repaired Uponor AquaPEX piping cool undisturbed to room temperature. When the piping returns to its opaque appearance, the repair is complete.

**Caution:** Do not allow surface temperature of the piping to exceed 338°F (170°C), and do not apply direct flame to the piping. Uponor AquaPEX piping repaired according to these recommendations will return to its original shape and strength. If the piping is sliced, punctured, or otherwise damaged beyond the capacity of the crosslinked memory, install a ProPEX coupling. Uponor PEX piping cannot be welded or repaired with adhesives.

**Note:** You may temporarily affix adhesive tape to Uponor PEX piping or ProPEX EP fittings during installation. However, to protect the integrity of the system, remove the tape and residual adhesive after completing the installation.



**Figure C-1: Reforming Kinked Piping**

## Thawing Frozen Piping

Uponor PEX can withstand extreme freeze-thaw cycles better than other piping materials. The crosslinking of the piping allows it to expand and absorb much of the expansion energy from the freezing process. In fact, the Plastics Pipe Institute (PPI) Technical Report (TR-52) proves the exceptional resiliency of PEX pipe in freeze/thaw cycles.

However, if freezing occurs, the contractor should advise the end user to correct the lack of insulation or heat to eliminate the problem from reoccurring.

Should Uponor PEX piping experience an ice blockage, thaw the piping using one or more of the following methods.

- Pour hot water over the affected portion of piping.
- Wrap hot towels around the affected portion of piping.
- Place a small portable heating unit in the area to heat the space and thaw the ice blockage from the piping.
- Slowly heat the affected area with a hair dryer. Rub a hand over the area while heating to ensure the piping does not get too hot.

## Appendix D

### Installation Checklist

Fittings, Connections, and Site Preparation	Yes	No	N/A	Notes and Comments
Proper storage to avoid UV exposure	<input type="checkbox"/>	<input type="checkbox"/>	<input type="checkbox"/>	
Ring properly against fitting stop on ProPEX connections	<input type="checkbox"/>	<input type="checkbox"/>	<input type="checkbox"/>	
Acceptable distance between fittings aligns with dimensions in <b>Table 3-1</b>	<input type="checkbox"/>	<input type="checkbox"/>	<input type="checkbox"/>	
Elbows replaced with bend supports	<input type="checkbox"/>	<input type="checkbox"/>	<input type="checkbox"/>	
Kinks or strains on fittings/pipe	<input type="checkbox"/>	<input type="checkbox"/>	<input type="checkbox"/>	
Trenches free from large stones	<input type="checkbox"/>	<input type="checkbox"/>	<input type="checkbox"/>	

Hangers/Supports	Yes	No	N/A	Notes and Comments
Proper horizontal support distance	<input type="checkbox"/>	<input type="checkbox"/>	<input type="checkbox"/>	
Proper use of supports on wood structure (tube talons)	<input type="checkbox"/>	<input type="checkbox"/>	<input type="checkbox"/>	
Grommets for steel-stud penetrations/nail plates for wood studs	<input type="checkbox"/>	<input type="checkbox"/>	<input type="checkbox"/>	
Proper support for out-of-the-wall applications	<input type="checkbox"/>	<input type="checkbox"/>	<input type="checkbox"/>	
Support multiport tees within 6"	<input type="checkbox"/>	<input type="checkbox"/>	<input type="checkbox"/>	
Sleeve concrete penetrations	<input type="checkbox"/>	<input type="checkbox"/>	<input type="checkbox"/>	
Seal slab penetrations	<input type="checkbox"/>	<input type="checkbox"/>	<input type="checkbox"/>	

Insulation	Yes	No	N/A	Notes and Comments
Insulation requirements verified	<input type="checkbox"/>	<input type="checkbox"/>	<input type="checkbox"/>	
Proper spacing (or insulation) from lighting fixtures	<input type="checkbox"/>	<input type="checkbox"/>	<input type="checkbox"/>	

Warranty Tag	Yes	No	N/A	Notes and Comments
"Uponor Plumbing System" tag installed in mechanical room	<input type="checkbox"/>	<input type="checkbox"/>	<input type="checkbox"/>	

**Moving  
> Water**

**Uponor**

**Uponor Inc.**

5925 148th Street West  
Apple Valley, MN 55124  
USA

T 800.321.4739  
F 952.891.2008

[uponor.com](https://www.uponor.com)

**Uponor Ltd.**

6510 Kennedy Road  
Mississauga, ON L5T 2X4  
CANADA

T 888.994.7726  
F 800.638.9517