

COMPONENTS



Uponor Q&E Termination Box M7
 1062936, PPSU 16-Rp1/2"FT 25/20
 1062931, DR 12-Rp1/2"FT 18/14,5
 1062932, NKB DR 15-Rp1/2"FT 25/20
 1062933, DR 16-Rp1/2"FT 25/20
 1062934, NKB DR 18-Rp1/2"FT 28/23
 1062935, DR 20-G1/2"FT 28/23



1062937
 Uponor Termination Box M7
 DR PEX 15x2,5-1/2"FT



1062958
 Uponor Leakage Indication Kit M7



1062946
 Uponor Mounting
 Tool with Spirit level M7



1059466
 Uponor Q&E Termination Box
 Cutting tool M7



1062963
 Uponor Termination Box
 Body Cap Female M7



1062944
 Uponor Assembling/Pull Out
 Tool M7



1062959
 Uponor Termination Box
 Extension M7



1067761
 Uponor Termination Box
 Tunnel Cap Female M7

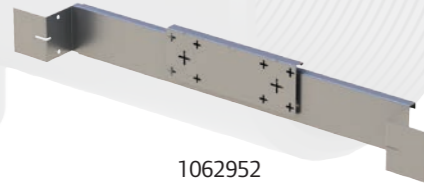

1062952
 Uponor Metal Mounting Bracket Set M7
 400-600 mm

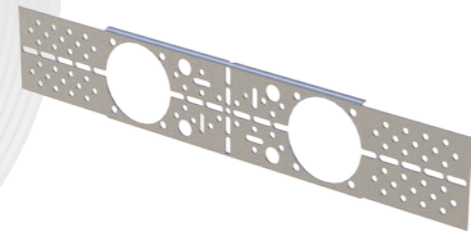

1062955 Uponor Wide Mounting
 Bracket M7 c/c 150 mm



1062965
 Uponor Floor Cover
 Plate with Clip 70/22 mm



1062966
 Uponor Floor Cover Plate with
 Clips, 130x70/22 c/c 60 mm



1062967 Uponor Floor Cover
 Plate, eccentric 110x70 c/c 40 mm
 G1/2" - G1/2"MT



1062968 Uponor Floor Cover
 Plate, eccentric 120x70 c/c 50 mm
 G1/2" - G1/2"MT

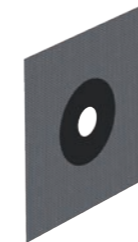

1067774
 Uponor Sealing
 Membrane M7

1063466
 Uponor Sealing Membrane
 for Conduit 25/20



1067762
 Uponor Termination Box
 Tunnel Cap Male M7

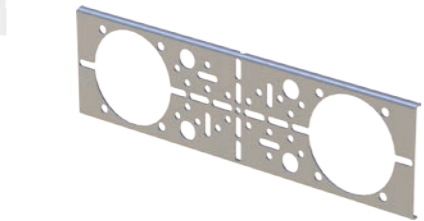

1062947 Uponor Mounting Bracket M7 c/c 80 mm
 1062948 Uponor Mounting Bracket M7 c/c 150 mm
 1062949 Uponor Mounting Bracket M7 c/c 160 mm



1044182
 Uponor Mounting
 Tool M7



1044183
 Uponor Mounting
 Tool Shaft M7

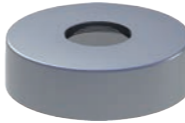

1062954
 Uponor Wall Cap Plated
 70x20 G3/4"FT



1062945
 Uponor Mounting
 Element M7



Uponor Termination
 Box M7

USER GUIDE

02 | 2014



www.uponor.com
 Uponor Corporation

1068208

FITTING ASSEMBLY

Q&E 5DR, PPSU



FPL-PX

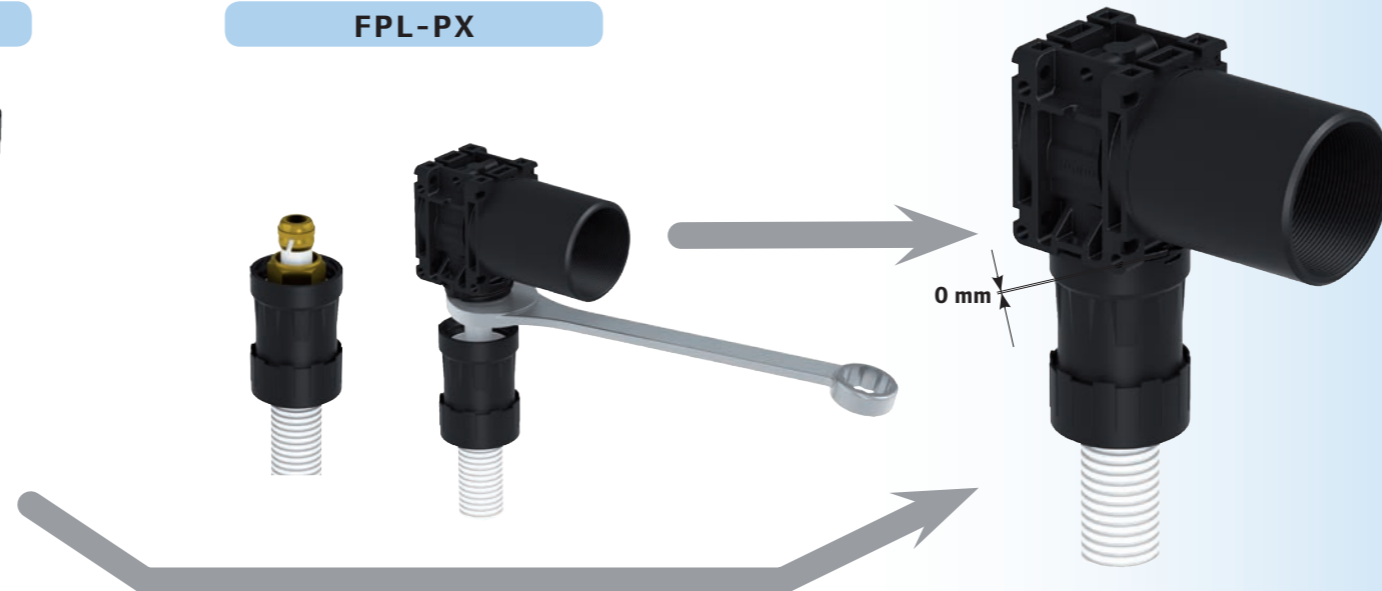

ASSEMBLY

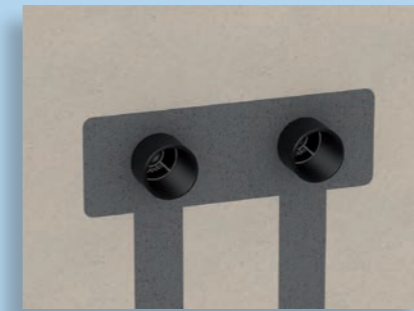
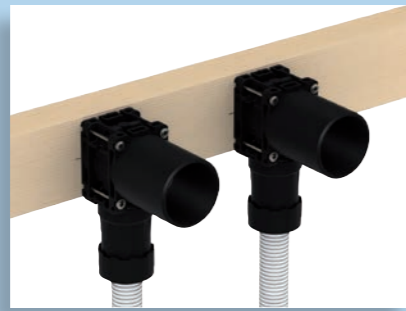

ALT. 1

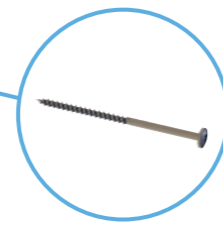
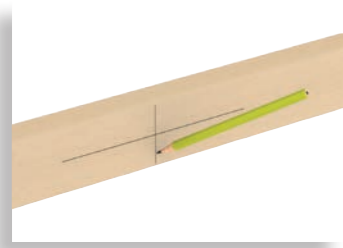

ALT. 2

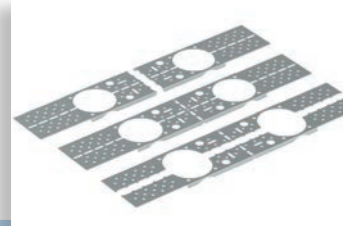

OR



OR



ALT. 3

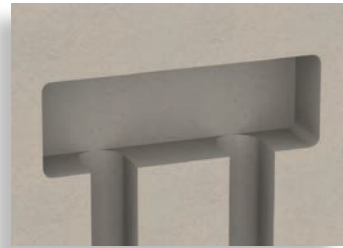

OR

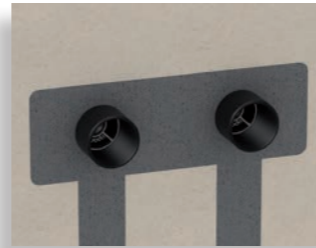

TESTING

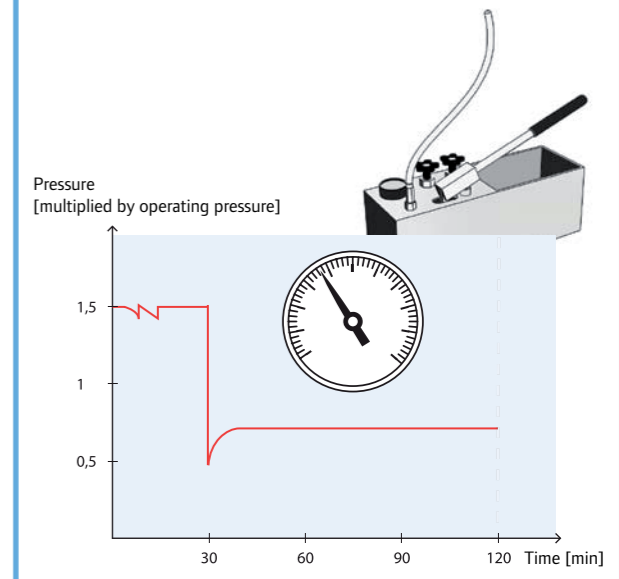

FOIL OR DISPERSION SYSTEM

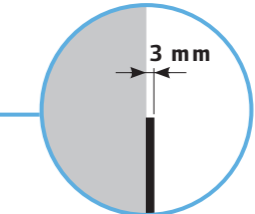
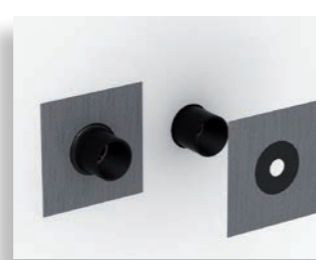
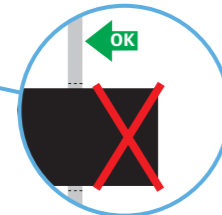
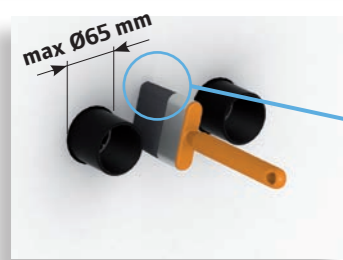

DISASSEMBLY

