

**uponor**

# **PEX Piping Systems Installation Guide**



PEX Piping Systems Installation Guide  
is published by

**Uponor Inc.**

5925 148th Street West  
Apple Valley, MN 55124  
USA

**T** 800.321.4739

**F** 952.891.2008

**Uponor Ltd.**

6510 Kennedy Road  
Mississauga, ON L5T 2X4  
CANADA

**T** 888.994.7726

**F** 800.638.9517

**uponor.com**

© 2024 Uponor

All rights reserved

Fifth edition

First printing November 2019

Printed in the United States of America

This piping systems installation guide is published for mechanical contractors, installers and building officials interested in Uponor PEX piping systems. It describes general installation recommendations that use Uponor PEX piping products. Refer to local codes for additional requirements.

Uponor made reasonable efforts to collect, prepare and provide quality information and material in this installation guide. However, system enhancements may result in modification of features or specifications without notice.

Uponor is not liable for installation practices that deviate from this installation guide or are not acceptable practices within the mechanical trades, codes or standards of practice.

Prior to installing Uponor piping systems, Uponor recommends all installers attend Uponor piping systems installation training performed by an Uponor trainer or manufacturer's representative. To schedule a training session at your business or job site, contact your local Uponor representative or call 800.321.4739.

Direct any questions regarding the suitability of an application or a specific design to a local Uponor representative by calling 888.594.7726 (U.S.) or 888.994.7726 (Canada).

ii | uponor.com

## Table of contents

Important safety information.....	1
Standards, codes and listings .....	1
Making ProPEX® connections.....	1
Making ProPEX connections with Milwaukee M12™, M12 FUEL™, M18™, or M18 FUEL™ 2" ProPEX expansion tools .....	5
Making ProPEX connections with Milwaukee M18 FORCE LOGIC™ ProPEX expansion tools.....	10
Making a ProPEX connection.....	12
Making 3/8" ProPEX connections .....	18
Proper expander tool and head maintenance .....	19
Cutting large-diameter PEX pipe.....	20
Troubleshooting ProPEX connections.....	21
Verifying ProPEX connections.....	25
Bending PEX.....	25
Reforming kinked piping.....	27
Thawing frozen piping.....	28
Uponor PEX ultraviolet (UV) resistance ratings .....	29
UV from light fixtures.....	29
Storing and handling PEX.....	30
Supporting Uponor PEX piping systems .....	32
Uponor PEX—a Pipe Support.....	35
Supporting Uponor multiport tees.....	42
Strapping .....	45
Bundling .....	45
Linear expansion and contraction.....	46
Protection of ProPEX fittings from clamps .....	59





## Important safety information

To reduce the risk of injury, read and understand this Uponor PEX Piping Systems Installation Guide before beginning work.

Read all product safety warnings and operator's manuals for the Milwaukee® Tool M12™, M12 FUEL™, M18™, M18 FUEL™, and FORCE LOGIC™ ProPEX expansion tools, PEX pipe cutters, and other installation tools to operate those tools safely and correctly.

Always wear safety goggles or safety glasses with side shields when performing work.



**WARNING:** Cancer and Reproductive Harm  
[www.P65Warnings.ca.gov](http://www.P65Warnings.ca.gov)

## Standards, codes, and listings

Uponor PEX pipe and ProPEX fittings are designed to all applicable industry standards, codes, and listings. Refer to our product submittals on [uponor.com](http://uponor.com), for complete details.

## Making ProPEX connections

Uponor ProPEX ASTM F1960 (CAN/CSA B137.5) cold-expansion fittings make solid, permanent, manufactured connections without the need for torches, glues, solder, flux, or gauges. The unique shape memory of Uponor PEX piping forms a tight seal around the fitting, creating a strong, reliable connection. This section shows how to make proper ProPEX connections using one of the following tools.

- Milwaukee M12, M12 FUEL, M18, and M18 FUEL 2" ProPEX expansion tools
- Milwaukee M18 FORCE LOGIC ProPEX Expansion Tool
- ProPEX 201 Corded Expander Tool
- ProPEX Hand Expander Tool

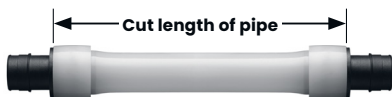
## Distance between fittings

Uponor requires a minimum distance between ProPEX fittings to avoid damaging the fittings during installation and to protect against elevated stress on the pipe and fittings. Refer to **Table 1** for the minimum distance between fittings, which is expressed as cut length of pipe.

Nominal fitting size	Cut length of pipe
½"	2"
¾"	3"
1"	3½"
1¼"	4½"
1½"	4½"
2"	6" or 6¾"*
2½"	7½"
3"	9"

**Table 1: Minimum distance between ProPEX fittings**

\*6¾" for Milwaukee M18 FUEL 2" ProPEX Expansion Tool.



**Figure 1: Distance between fittings**

## General ProPEX connection tips

- If the fitting does not slide into the piping all the way to the stop, immediately remove it from the piping and expand the piping one final time.

**Note:** To avoid over-expanding the piping, do not hold the piping in the expanded position.

- **Table 2** shows the recommended number of expansions. Experience, technique, and weather conditions influence the actual number of expansions. Fewer expansions may be necessary under certain conditions. The correct number of expansions is the amount necessary for the piping and the shoulder of the fitting to fit snugly together.
- Ensure the ProPEX ring rests snugly against the fitting shoulder. If there is more than  $\frac{1}{16}$ " (1 mm) between the ring and the shoulder of the fitting, the connection must be replaced. Square cut the piping 2" away from the fitting for  $\frac{3}{8}$ " to 1" pipe, 3" away for  $\frac{1}{4}$ " to 2" pipe, and 5" away for  $2\frac{1}{2}$ " and 3" pipe prior to making the new connection.
- Brass ProPEX fittings can be disconnected and reused. EP fittings must be discarded. Be sure to follow the recommended minimum distance between ProPEX fittings shown in **Table 1**.

Pipe size	Milwaukee ProPEX expansion tools					Uponor ProPEX expander tools		
	M12 with standard heads (2432)	M12 FUEL with RAPID SEAL™ heads (2532)	M18 (2632)	M18 FUEL 2" (2932)	M18 FORCE LOGIC (2633)	Manual	100/150	201
3/8"	6-7	6-10	5	5-7	—	5	7	—
1/2"	7-8	5-8	9	7-9	—	4	4	—
5/8"	9-10	6-10	9	8-9	—	9	9H	—
3/4"	11-12	7-12	10	9-11	—	14	7H	—
1"	17-18	12-18	19	12-13 (or 7-8H)	—	—	7H	—
1 1/4"	—	—	9	9-10H	—	—	8H	—
1 1/2"	—	—	10	8-9H	—	—	—	—
2"	—	—	—	9-10	4	—	—	5H
2 1/2"	—	—	—	—	5	—	—	—
3"	—	—	—	—	7	—	—	—

**Table 2: Recommended number of expansions for 3/8" to 3" piping at 73.4°F (23°C)**

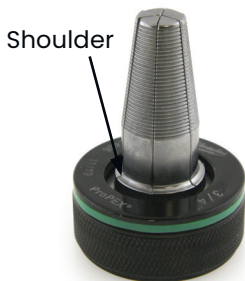
**Note:** "H" in the table refers to Uponor H-series expander heads.

## Making ProPEX connections with Milwaukee M12, M12 FUEL, M18, or M18 FUEL 2" ProPEX expansion tools

**Note:** All standard Uponor expander heads are compatible with the M12 and M18 tools. Uponor expander heads will not auto-rotate on the Milwaukee tools (only Milwaukee expansion heads will auto-rotate on the M12 and M18). H-heads are not compatible with Milwaukee tools and Milwaukee heads are not compatible with Uponor tools. Milwaukee heads are easily distinguished by color coding and the Milwaukee logo.



**Figure 2:  $\frac{3}{8}$ " and  $\frac{1}{2}$ " Milwaukee expansion heads**



**Figure 3:  $\frac{3}{4}$ " to 3" Milwaukee expansion heads**

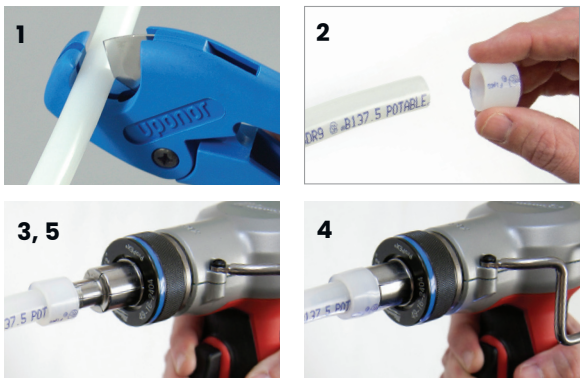
**Important!** Making expansions are slightly different when using a tool that features auto rotation. When making a ProPEX connection, be sure to follow the guidelines for the tool you are using in your application.

1. Square cut the PEX piping perpendicular to the length of the piping. Remove all excess material or burrs that might affect the fitting connection.
2. Slide the ProPEX ring over the end of the piping until it reaches the stop edge. If using a ProPEX ring without a stop edge, extend the ring over the end of the piping no more than  $\frac{1}{16}$ " (1mm).

**Important!** If making a  $\frac{3}{8}$ " ProPEX connection, first expand each side of the ring before placing it on the piping. Refer to the "Making  $\frac{3}{8}$ " ProPEX connections" instructions on **page 18** for further information.

### **With auto rotation (standard Milwaukee heads)**

3. Milwaukee ProPEX expansion tools come with built-in auto rotation. If using a Milwaukee expansion head, simply hold the piping and tool in place while holding the trigger to expand the piping. The head will automatically rotate to ensure the piping is evenly expanded. Continue expanding and rotating until the piping and ring are snug against the shoulder on the expander head. See **Table 2** for the recommended number of expansions for each piping size.



**Figure 4: Expansion with Milwaukee M12, M12 FUEL, M18, and M18 FUEL 2" ProPEX expansion tools**

**Note:** Do not force the pipe onto the expander head. Ensure the expander head is rotating during each expansion.

**Without auto rotation  
(standard Uponor heads)**

4. Press the trigger to expand the piping.
5. Release the trigger, remove the head from the piping, rotate it  $\frac{1}{8}$  turn and slide the head back into the piping. Continue expanding and rotating until the piping and ring are snug against the shoulder on the expander head. See **Table 2** for the recommended number of expansions.

**Important!** Rotating the tool between expansions will provide smooth, even expansion of the piping. Failure to rotate the tool will cause deep grooves in the piping which can result in potential leak paths.



**Figure 5: Inserting ProPEX fitting into ½" Uponor PEX piping**



**Figure 6: Inserting ProPEX fitting into 1" Uponor PEX piping**

6. After the final expansion, immediately remove the tool and insert the fitting. Ensure the piping and ring seat against the shoulder of the fitting.



**Important!** Only perform the necessary number of expansions. DO NOT over expand the pipe. You should feel some resistance as the fitting goes into the piping. If you do not feel any resistance, the piping may be over expanded and will require additional time to shrink over the fitting.



**Figure 7: ProPEX coupling**



**Figure 8: ProPEX tee**



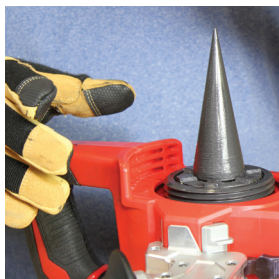
**Figure 9: Expansion with Milwaukee M18 ProPEX Expansion Tool**

# Making ProPEX connections with Milwaukee M18 FORCE LOGIC ProPEX expansion tools

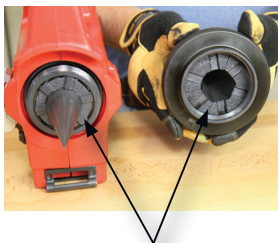
## FORCE LOGIC expansion head installation

The Milwaukee FORCE LOGIC ProPEX Expansion Tool for 2", 2½", and 3" Uponor PEX pipe features an auto-rotating head with specially designed alignment cogs. This requires slightly different head installation than the M12 and M18 ProPEX expansion tools for ¾" to 1½" pipe sizes.

1. Remove the battery pack and place the FORCE LOGIC tool in the upright position (cone up).
2. Verify the expansion cone is fully retracted.
3. Screw the head onto the tool (clockwise). Hand-tighten securely. Do not over tighten. Ensure the expansion head fits flush against the tool.



**Figure 10: FORCE LOGIC expansion head installation**



**Auto-rotate teeth**

**Figure 11: FORCE LOGIC expansion head auto-rotate teeth**

4. Check the installation.
  - a. Ensure the head segments do not “flower”
  - b. If the head flowers, correct the installation by loosening the head slightly and rotating the segments until they engage in the cogs. Re-tighten the head.
  - c. Rotate the six expansion segments in the clockwise direction. They will rotate freely. They should not rotate counter clockwise.
  - d. The expansion head collar will fit flush against the tool.



**Figure 12: Incorrect expansion head “flowering”**



**Figure 13: Correct expansion head alignment**

## Making a ProPEX connection

1. Square cut the pipe perpendicular to the length, and remove all excess material or burrs.
2. Slide the ProPEX ring over the end of the piping until it reaches the stop edge.
3. The tool features auto rotation so the head will automatically rotate to ensure the piping is evenly expanded.

**Note:** To cancel the expansion process quickly, pull and release the trigger.

4. Press the trigger to initiate the rotation of the head. A green light will turn on and the work light will blink. Insert the pipe and ring and release the trigger. When the expansion head has reached its maximum diameter, it will retract.



**Figure 14: Cut pipe**



**Figure 15: Add ring**



**Figure 16: Ensure ring reaches stop edge**

**Important!** Do not force the pipe and ring on the head during any expansion.

5. After the tool has retracted, the green indicator light blinks three times. Press the trigger and repeat the expansion process.
6. Repeat the process until the pipe and ring are snug against the shoulder of the expansion head. Repeat the expansion one or two more times depending on the ambient temperature.

**Note:** Colder temperatures require fewer expansions.

7. After final expansion, immediately remove the tool and insert the fitting.



**Figure 17: Begin expanding**



**Figure 18: Expand to shoulder**



**Figure 19: Insert fitting**

## Making ProPEX connections with ProPEX 201 corded expander tools

1. Square cut the PEX piping perpendicular to the length of the piping. Remove all excess material or burrs that might affect the fitting connection.
2. Slide the ProPEX ring over the end of the piping until it reaches the stop edge. If using a ProPEX ring without a stop edge, extend the ring over the end of the piping no more than  $\frac{1}{16}$ " (1 mm).

3. Slide the expander head into the piping until it stops. Full expansions are necessary to make a proper connection.



**Figure 20: Cut pipe**



**Figure 21: Add ring**



**Figure 22: Slide head into piping**

4. Press the trigger to expand the piping.



**Figure 23: Begin expanding**

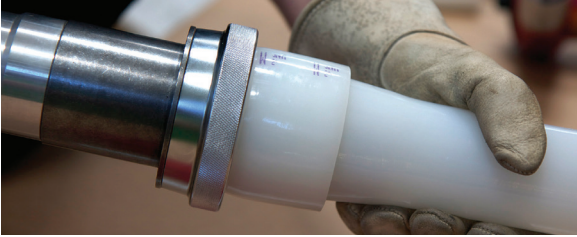
5. Release the trigger, remove the head from the piping, rotate it  $\frac{1}{8}$  turn and slide the head back into the piping. Continue expanding and rotating until the piping and ring are snug against the shoulder on the expander head. See **Table 2** for recommended number of expansions.



**Figure 24: Rotate head**

**Important!** Rotating the tool between expansions will provide smooth, even expansion of the piping. Failure to rotate the tool will cause deep grooves in the piping which can result in potential leak paths.

6. After the final expansion, immediately remove the tool and insert the fitting. Ensure the piping and ring seat against the shoulder of the fitting.



**Figure 25: Expand to shoulder**



**Figure 26: Insert fitting**

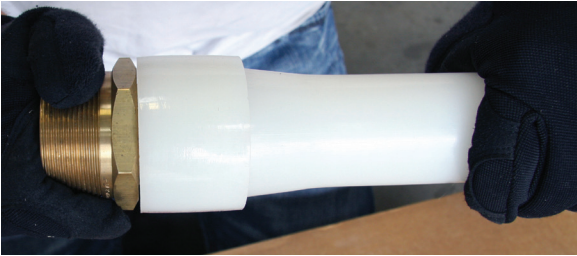


**Figure 27: Ensure piping and ring seat against shoulder of fitting**





**Figure 28: ProPEX EP tee connected to pipe**



**Figure 29: ProPEX brass fitting connected to pipe**

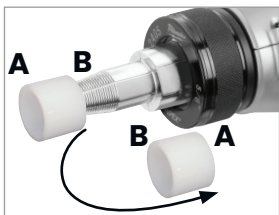
## Making $\frac{3}{8}$ " ProPEX connections

When making a  $\frac{3}{8}$ " ProPEX connection, expand the ring once on each side to properly fit over the piping. Refer to the following instructions to make a  $\frac{3}{8}$ " ProPEX connection.

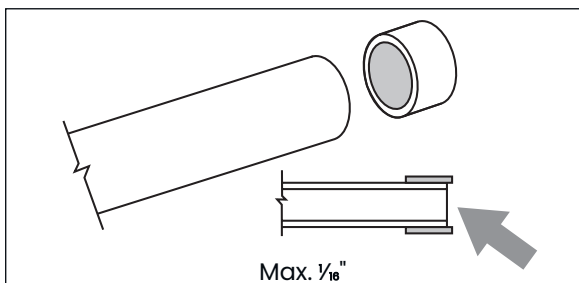
1. Square cut the PEX piping perpendicular to the length of the piping. Remove all excess material or burrs that might affect the fitting connection.
2. Expand each side of the ring once.
3. Slide the expanded ring over the end of the piping. Extend the end of the ring over the end of the piping no more than  $\frac{1}{16}$ " (1 mm).



**Figure 30: E6081128 pipe cutter (plastic)**



**Figure 31: Expand each side of the ring**



**Figure 32: Slide the expanded ring over the end of the piping**

4. After the ring is on the piping, continue with the regular steps for making a proper connection with your specific tool.

### Important tips for a proper $\frac{3}{8}$ " ProPEX connection

- The thicker  $\frac{3}{8}$ " ProPEX Ring shrinks over the fitting faster than larger-sized rings.
- When the temperature is below 40°F (4.4°C), fewer expansions are required.

## Proper expander tool and head maintenance

- Use a lint-free cloth to apply a light coat of lubricant to the cone prior to making any ProPEX connections.
- If used regularly, apply the lubricant daily to the cone of the ProPEX expander tool. Failure to keep the tool lubricated may result in improper connections.



**Caution:** Excessive lubrication may result in improper connections. Only use a small amount of lubrication to keep the tool working properly.

- Keep all other parts of the tool free from lubricant.
- Once a month, soak the heads in degreasing agent to remove any grease from between the segments. Clean the cone using a clean, dry cloth.

## Cutting large-diameter PEX pipe



**Caution:** Read and thoroughly understand all safety instructions in the pipe cutter operator's manuals before performing work.



**Caution:** Be sure to wear safety gloves and proper eye protection prior to cutting pipe. Failure to do so could result in personal injury.

Use a swing or ratchet-type cutter to create smooth, clean cuts.



**Figure 33: Uponor swing-style pipe cutter for up to 4" pipe (E6084000)**



**Figure 34: Uponor ratchet-style pipe cutter for up to 3" pipe (E6083000)**

## Troubleshooting ProPEX connections

Trouble-free ProPEX installations begin with a tool that is maintained in proper working condition. If the tool or segment fingers are damaged, it is very difficult to make a proper connection. Refer to the following guidelines to assist with challenges in the field.

### Fittings won't seal

- Make sure the expander head is securely tightened onto the tool.
- Ensure the segment fingers are not bent. If the head does not completely close when the drive unit is fully retracted or the handles of the manual tool are open, replace the head.
- Examine the tool for excess grease on the segment fingers. Remove excess grease prior to making connections.
- Check the fitting for damage. Nicks and gouges will cause the fitting to leak.
- Make sure the internal driver cone is not damaged or bent.
- Make sure the last expansion is not held in the expanded position before the fitting is inserted. You should feel some resistance as the fitting goes into the piping. If you do not feel any resistance, the piping may be over expanded and will require additional time to shrink over the fitting.
- Be sure to rotate the tool  $\frac{1}{8}$  turn after each expansion to avoid deep grooves in the piping which can result in potential leak paths.

## **Expansion is difficult**

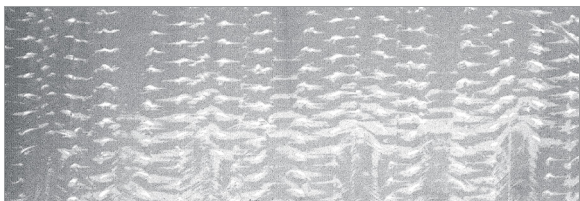
- Make sure the internal cone is properly greased.

## **Expansion head slips out of piping when making expansions**

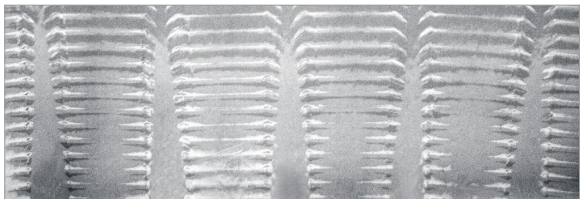
- Ensure the piping and ProPEX ring are dry.
- Make sure that grease is not getting into the piping.
- Examine the segment fingers to ensure they are not damaged or bent.

## **ProPEX ring slides down piping during expansion**

- Ensure your hands are clean while handling the piping. Any sweat or oils on your hands can act as a lubricant. Due to the smoothness of PEX, any form of lubricant can cause the ProPEX ring to slide down the piping during expansion.
- If you anticipate the ProPEX ring may possibly slide down, position the ring slightly farther over the end of the piping and make the first couple of expansions slowly. Once the ring and the piping begin to expand together, continue with the normal number and type of expansions.
- Place your thumb against the ProPEX ring to help support it and feel for any movement. If caught early, you can slide the ring up the piping and expand as described in the previous bullet point.



**Figure 35: Expansion with proper rotation**



**Figure 36: Expansion without proper rotation**

**More than the recommended number of expansions are needed to make a connection**

- Ensure the head is hand-tightened to the expander tool.
- Examine the segment fingers for damage.
- Be sure to completely cycle the tool on each expansion (i.e., close the manual tool handle or release the trigger).

**Cold-weather expansions**

- Uponor recommends the use of the Milwaukee M12 FUEL ProPEX expansion tool with RAPID SEAL™ heads for cold-weather installation of  $\frac{3}{8}$ " to 1" Uponor piping systems.

- Temperatures affect the time required for the piping and ring to shrink onto the fitting. The colder the temperature, the slower the contraction time.
- Warming ProPEX fittings and ProPEX rings reduces contraction time. Put fittings and rings in your pockets prior to installation to keep them warm.
- Fewer expansions are necessary in temperatures below 40°F (4.4°C).

**Note:** Do not use a heat gun on EP fittings to speed up the contraction time as this could result in damage to the fitting.



**Figure 37: Milwaukee RAPID SEAL 1" head**



## Verifying ProPEX connections

Ensure the ProPEX ring is tight against the fitting shoulder.



**Figure 38: Coupling shoulder**



**Figure 39: Tee shoulder**

## Bending PEX

### Uponor PEX bend radius

The minimum bend radius of Uponor PEX pipe is six times the outside diameter. Bend supports are available for  $\frac{3}{8}$ ",  $\frac{1}{2}$ ",  $\frac{3}{4}$ ", and 1" piping and may be used to facilitate 45-degree or 90-degree bends. Use large-diameter PVC conduit to facilitate 90-degree bends in larger-diameter Uponor PEX piping.

Pipe size	Pipe O.D.	Min. bend radius	2 x O.D.
$\frac{1}{2}$ "	0.625"	3 $\frac{3}{4}$ " (95mm)	1 $\frac{1}{4}$ " (32mm)
$\frac{3}{4}$ "	0.875"	5 $\frac{1}{4}$ " (133mm)	1 $\frac{3}{4}$ " (44mm)
1"	1.125"	6 $\frac{3}{4}$ " (171mm)	2 $\frac{1}{4}$ " (57mm)

**Table 3: Bending Uponor PEX**

To alleviate stress on ProPEX connections and fittings, do not change direction immediately after a ProPEX connection.

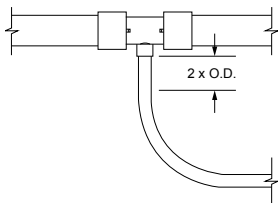
Uponor recommends a minimum of two times the outside diameter (O.D.) of the pipe as the minimum distance before changing direction; however, it is up to the installer to use best judgment. See **Figures 41** and **42** for guidance.

**Note:** When a proper bend is not possible, use a ProPEX elbow.

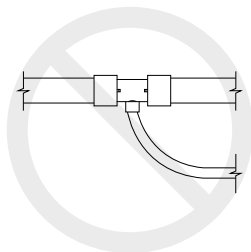
**Note:** Uponor recommends the use of elbows in sizes  $1\frac{1}{4}$ " and larger for directional changes unless adequate space is available for a proper bend.



**Figure 40: Bend radius**



**Figure 41: Correct bending**



**Figure 42: Incorrect bending**

## Reforming kinked piping

If the piping is kinked and hinders flow, easily make repairs following the steps below.

1. Make sure the system is not pressurized.
2. Straighten the kinked portion of the piping.
3. Heat the kinked area to approximately 265°F/129.4°C with an electric heat gun



### Figure 43: Reforming kinked piping

(approximately 450 watts of power). Apply the heat evenly until the piping returns to its original size and shape. **Do not use an open flame** (see **Figure 43**).

4. Allow the repaired piping to cool undisturbed to room temperature. When the piping returns to its opaque appearance, the repair is complete.

**Caution:** The piping surface temperature must not exceed 338°F/170°C. Do not apply direct flame to Uponor PEX piping. Uponor PEX piping repaired according to these recommendations will return to its original shape and strength. If the piping is sliced, punctured or otherwise damaged beyond the capacity of the crosslinked memory, install a ProPEX coupling. Uponor PEX piping cannot be welded or repaired with adhesives.

## Thawing frozen piping

Uponor PEX can withstand extreme freeze-thaw cycles better than other piping materials. The crosslinking of the piping allows it to expand and absorb much of the expansion energy from the freezing process. In fact, the Plastics Pipe Institute (PPI) Technical Report (TR-52) proves the exceptional resiliency of PEX pipe in freeze/thaw cycles.

If freezing occurs, the installer should advise the end user to correct the lack of insulation or heat to eliminate the problem from reoccurring. Should Uponor PEX piping experience an ice blockage, thaw the piping using one or more of the following methods.

- Pour hot water over the affected portion of piping.
- Wrap hot towels around the affected portion of piping.
- Place a small portable heating unit in the area to heat the space and thaw the ice blockage from the piping.
- Slowly heat the affected area with a hair dryer. Rub a hand over the area while heating to ensure the piping does not get too hot.

## Uponor PEX ultraviolet (UV) resistance ratings

Product	Marking	UV resistance
Uponor AquaPEX White	5106	1 month
Uponor AquaPEX White with Blue Print	5106	1 month
Uponor AquaPEX White with Red Print	5106	1 month
Uponor AquaPEX Purple	5106	1 month
Uponor AquaPEX Blue	5306	6 months
Uponor AquaPEX Red	5306	6 months
Uponor ServicePEX	5306	6 months*

**Table 4: Uponor PEX UV resistance ratings**

\*ServicePEX has been **tested** and **proven** to withstand **12 months of UV exposure**.

### UV from light fixtures

Do not install PEX within 5 ft. (1.5 m) of direct view from fluorescent and LED lights unless protected with a UV-blocking material (i.e., approved insulation or plastic wrap/sleeve).

## Storing and handling PEX

Although not comprehensive, the following highlights the most common guidelines when storing and handling Uponor PEX.

- Uponor PEX is approved for direct connection to electric water heaters as well as power-vented gas water heaters where allowed by local code.
- Do not store Uponor PEX piping outdoors.
- Keep Uponor PEX piping in the original packaging until the time of installation.
- Do not use Uponor PEX piping where temperatures and pressures exceed ratings.
- Do not use or store Uponor PEX piping products where they will be exposed to direct sunlight beyond their UV ratings. Refer to **Table 4** for the UV ratings of each Uponor PEX product.
- Do not weld or glue to join Uponor PEX piping.
- Do not apply open flame to Uponor PEX piping.
- Minimum clearance from Insulation Contact (I.C.)-rated fixtures is 2". Minimum clearance from non-I.C. rated fixtures is 12". For distances closer than the above minimums, protect the pipe with an approved insulation.
- Do not install Uponor PEX within 5 ft. of direct view from fluorescent and LED lighting without protecting the pipe with a UV-blocking material.
- Do not use Uponor PEX piping to convey natural gas.

- Do not solder, braze, weld or fusion-weld within 18" of any Uponor PEX piping in the same water line. Make any heat-related connections prior to making the ProPEX connection.
- Do not install Uponor PEX piping between the tub/shower valve and tub spout.
- Do not use Uponor PEX piping for an electrical ground.
- Do not spray on or allow organic chemicals, strong acids or strong bases to come into contact with Uponor PEX piping.
- Do not use petroleum or solvent-based paints, greases or sealants on Uponor PEX piping.
- Use only approved and appropriate firestop materials with Uponor PEX piping.
- Do not allow rodents, insects or other pests to come into contact with Uponor PEX piping.
- Do not subject Uponor PEX piping to blunt impact.
- Do not install Uponor PEX piping in soil environments contaminated with solvents, fuels, organic compounds, pesticides or other detrimental materials that may cause permeation, corrosion, degradation or structural failure of the piping. In areas where such conditions are suspected, perform a chemical analysis of the soil or groundwater to ascertain the acceptability of Uponor PEX piping for the specific installation. Check local codes for additional requirements.
- Do not press standard ProPEX LF brass fittings or standard brass (i.e., copper press). Only

press Uponor ProPEX copper press adapters.

- Do not install Uponor PEX pipe in steel-stud applications without the use of grommets to protect the pipe from abrasion.
- Do not install Uponor PEX within 6" (15.2cm) of a vent pipe for direct or gravity-vented appliances.\*
- For chemical compatibility questions, contact Uponor Technical Services at 888.594.7726 (U.S.) or 888.994.7726 (Canada).

\*Maintain a minimum 1" (25mm) distance from double-wall B vents or zero-clearance plastic vents.

**Note:** When transitioning from Uponor PEX to other piping materials, follow the appropriate installation instructions for that product.

## **Supporting Uponor PEX piping systems**

When determining support-types and distances, it is important to take into account both the local code requirements, as well as the specific manufacturer's requirements for their product. This is because the manufacturer may have requirements above and beyond code to protect the integrity of the piping system due to its unique properties (e.g., thermal expansion or contraction control).

### **General requirements for supporting PEX pipe**



- Use copper tube size (CTS) supports and clamps whenever possible.
- Use supports and clamps that are free of any sharp edges.
- Do not overtighten clamps.
- Isolate piping from other mechanical, electrical, and plumbing (MEP) systems.
- Do not strap pipe directly to DWV piping systems.

### **Code requirements**

As a minimum, follow local code requirements when supporting Uponor PEX piping. Note that these code requirements do not account for linear growth or movement due to expansion or contraction. See **Table 5**.

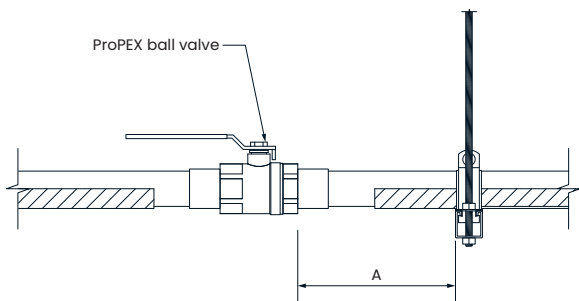
**Note:** In fire-rated assemblies, the penetration is not acting as support for the pipe. The pipe will still need to be supported per **Table 5**.

Nominal pipe size	Maximum horizontal spacing		Maximum vertical spacing		
	IPC/IMC/ UPC/UMC	National Plumbing Code of Canada	IPC/IMC	UPC/UMC	National Plumbing Code of Canada
PEX pipe 1" and smaller	32 inches	0.8 m	10 feet <sup>1</sup>	Base and each floor; provide mid-story guides	Support at the base and at the floor of alternate stories; not to exceed 7.5 m <sup>2</sup>
	4 feet				
PEX pipe 1¼" and larger					

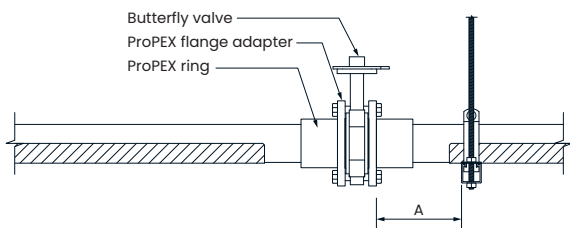
**Table 5: Support requirements for crosslinked polyethylene (PEX) pipe by code**

<sup>1</sup> For sizes 2 inch and smaller, a guide shall be installed midway between required vertical supports. Such guide shall prevent pipe movement in a direction perpendicular to the axis of the pipe.

<sup>2</sup> Although not required by the National Plumbing Code of Canada, Uponor recommends the use of vertical supports at five feet for sizes 2 inch and smaller to minimize pipe movement.



**Figure 44: Supporting 1¼" to 2" ball valves**



**Figure 45: Supporting 2½" to 3" butterfly valves**

## Uponor PEX-a Pipe Support

PEX-a Pipe Support is a 23-gauge galvanized-steel channel for PEX piping with a CTS (copper tube size) controlled outside diameter. It features a profile that is over half-round, making it self-gripping. It provides continuous, uninterrupted support of PEX piping, allowing increased hanger spacing over bare PEX.

## Product offering

Uponor PEX-a Pipe Support is available in 9-foot (3 m) lengths for ½" through 3" pipe sizes.

## Nylon strapping

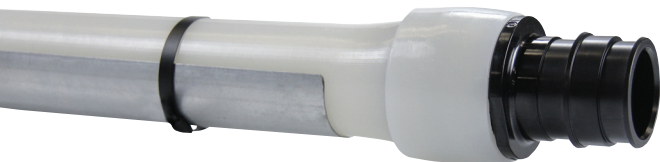
Each bundle of PEX-a Pipe Support includes a package of nylon straps. They are temperature rated to 180°F (82.2°C), UV rated, carry a 120-lb. tensile rating, and are tested for Uponor-supported applications.

## Insulating PEX-a Pipe Support

The low profile of PEX-a Pipe Support allows insulation with typical CTS pipe insulation

## Important tips for installing PEX-a Pipe Support

- Always follow local code for general piping support requirements.
- Use the included 120-lb. nylon straps to secure the support channel to the pipe. If the straps are misplaced, use a nylon strap of equal or greater strength that is temperature rated for the application.



**Figure 46: Uponor PEX-a Pipe Support with nylon strapping**

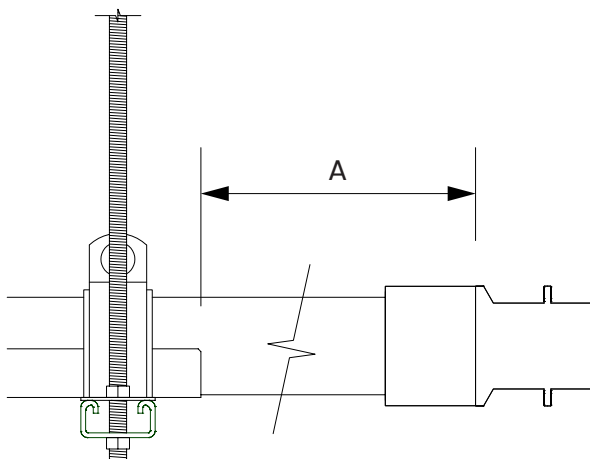
- Due to expansion characteristics of Uponor PEX piping, it is important to use a minimum 120-lb. nylon cable tie or equivalent for securing the support to the piping. Ensure ties are intended for applications up to 180°F (82.2°C) and are UV-rated.

### **Tips for cutting PEX-a Pipe Support**

- Always cut the PEX-a Pipe Support starting from the round side.
- When using a reciprocating or band saw to cut the PEX-a Pipe Support, either place the support flat-side down to make a clean cut or place a scrap piece of pipe into the support before cutting.
- When using a hand tool such as tin snips to cut the PEX-a Pipe Support, place the support flat-side down and mark a line on the support to follow.
- When cutting a support, take care not to bend it.
- After cutting PEX-a Pipe Support, taper and smooth any sharp edges.

Nominal pipe size	Min. distance to fitting (A)
½"	1¼"
¾"	1¾"
1"	2¼"
1¼"	2¾"
1½"	3"
2"	4"
2½"	5"
3"	6"

**Table 6: Uponor PEX-a Pipe Support minimum distance to fittings**



**Figure 47: Minimum distance to fitting**

## **Increasing horizontal support spacing distances**

Horizontal support spacing distances for Uponor PEX may be increased up to 8 feet (2.4 m) with the use of Uponor's PEX-a Pipe Support and straps (see **Table 7**). PEX-a Pipe Support is a 23-gauge galvanized-steel channel that is secured onto the bottom of Uponor PEX pipe and provides a continuous, rigid support.

Additionally, PEX-a Pipe Support, when used with clamps and fixed points, helps to reduce linear expansion (or contraction) in the piping system. Together, you get all the benefits of a polymer piping system with aesthetics similar to those of a metallic piping system. Refer to ICC PMG-1006 for more information and applicable code approvals.

System type	Maximum support spacing with PEX-a Pipe Support	Fixed points
$\Delta T$ less than or equal to 40°F (22.2°C) (e.g. domestic cold water; chilled water) <sup>1</sup>	8 feet (2.4 m); clamps not required	Not required
$\Delta T$ greater than 40°F (22.2°C) (e.g. domestic hot water; domestic hot-water return; heating hot water) <sup>1</sup>	8 feet (2.4 m) with clamps every 32 feet (9.7 m) max. <sup>2</sup>	See <b>Table 8</b>

**Table 7: Horizontal support recommendations with PEX-a Pipe Support**

<sup>1</sup> System examples are for reference only. Delta T ( $\Delta T$ ) shall determine actual support requirements.

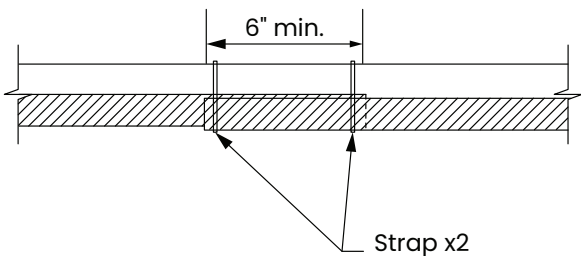
<sup>2</sup> Fittings 1½" and smaller require support within 12 inches (0.3 m) to prevent sagging. Tees may be supported from their respective branch pipe.

**Note:** Delta T as referenced in the above table refers to the temperature difference between the ambient air temperature and the system water temperature.



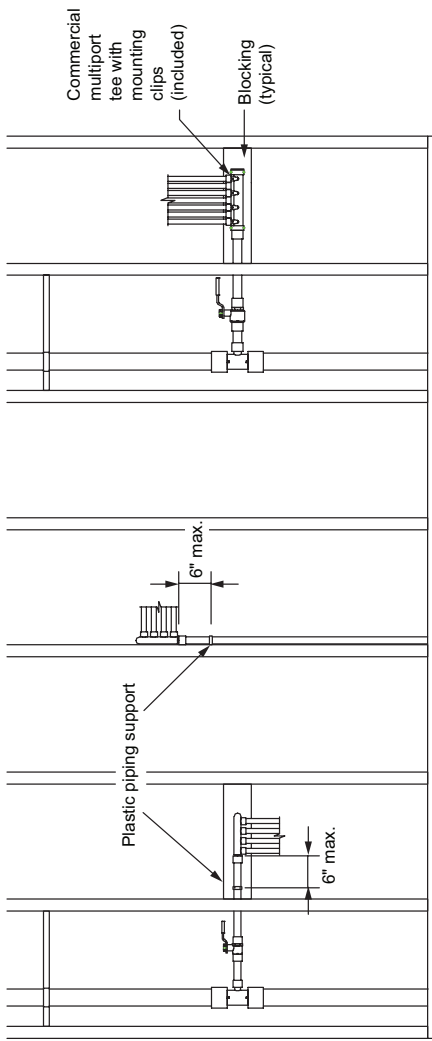
## PEX-a Pipe Support straps

Uponor PEX-a Pipe Support is secured to the bottom of the PEX pipe using the three (3) included straps. The straps are nylon and feature a 120-lb. tensile rating. If the straps are misplaced, use straps of equal or greater strength in their place. Straps should be spaced every 3 feet (0.9 m) maximum. Refer to **Figure 48** for strapping at overlaps.

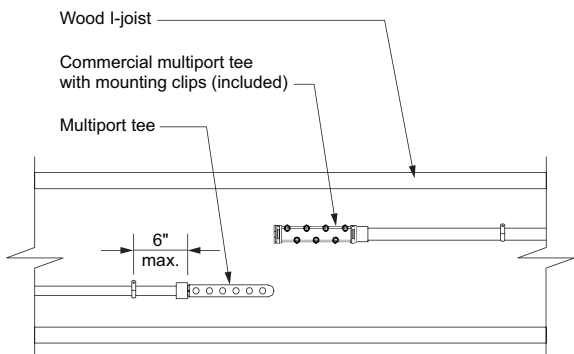


**Figure 48: Strapping overlaps**

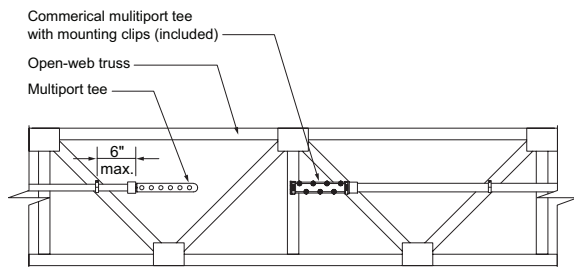
## Supporting Uponor multiport tees



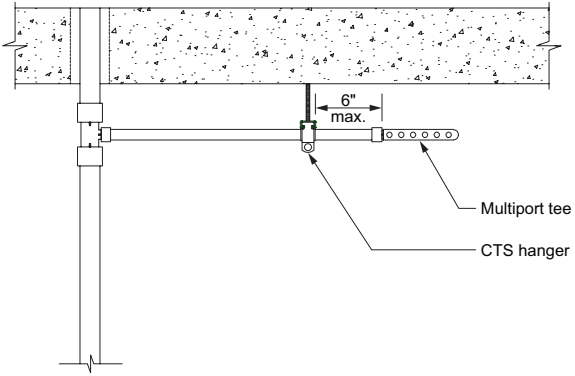
**Figure 49: In-wall supports for multiport tees**



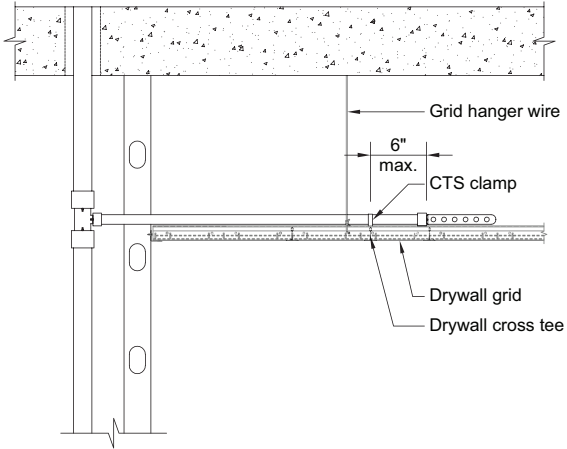
**Figure 50: Supporting multiport tees on wood I-joists**



**Figure 51: Supporting multiport tees on open-web wood trusses**



**Figure 52: Supporting multiport tees in suspended applications**



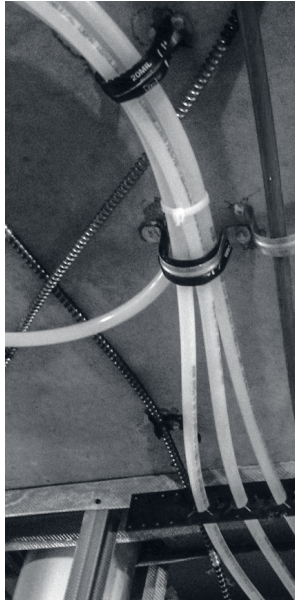
**Figure 53: Supporting multiport tees on drywall grid**

## Strapping

Support Uponor PEX pipe by approved materials/methods only, including:

- Tube talons
- Clamps and hangers (i.e., loop or clevis hangers)
- Stand-off brackets

Isolate piping from other mechanical, electrical and plumbing (MEP) systems by means of insulation or stand-off brackets. Uponor does not recommend strapping PEX pipe directly to waste and vent piping. Always follow local code.



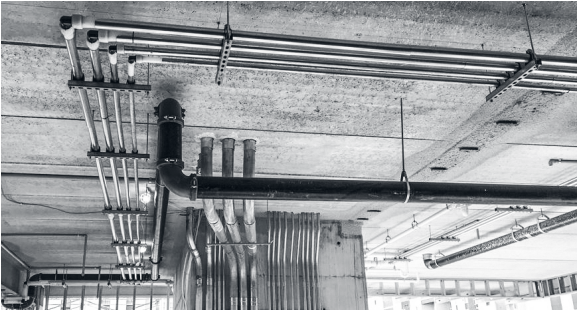
**Figure 54: Proper bundling of Uponor PEX**

## Bundling

Parallel runs of Uponor PEX may be bundled together, when approved by local code, given the following:

- Bundle hot and cold water pipes separately at least 6" apart (15.2cm), unless piping is insulated.
- Support the bundle at the required on-center distance.
- Use cable ties to group a bundle.\*

\*Cable ties are not approved for supporting pipe.



**Figure 55: Supporting PEX with PEX-a Pipe Support**

## **Linear expansion and contraction**

An important consideration when supporting Uponor PEX piping systems are the effects of linear expansion or contraction due to the temperature difference ( $\Delta T$ ) between the ambient temperature of the space and the fluid operating temperature (e.g., ambient space temperature of 70°F and a fluid operating temperature of 140°F equals a 70°F  $\Delta T$ ). Generally, the greater the  $\Delta T$ , the more the pipe will expand or contract. To help minimize this movement or growth, Uponor recommends the use of our PEX-a Pipe Support and straps, along with the requirements set forth in **Tables 7** and **8**.

Length of straight piping run	Number of fixed points*	Fixed point spacing
0 - 63 ft. (0 - 19.2 m)	0	N/A
64 - 128 ft. (19.5 - 39 m)	1	Closest support with clamps to center
129 - 192 ft. (39 - 58.5 m)	2	Min. 64 ft. (19.5 m) apart
193 - 256 ft. (58.8 - 78 m)	3	
257 - 320 ft. (78.3 - 97.5 m)	4	

**Table 8: Fixed point recommendations for linear expansion/contraction control in horizontal applications**

\*Pipes 1" and smaller do not require fixed points.

### Test validation

Through internal testing, Uponor has determined that the combination of the PEX-a Pipe Support, clamps and fixed points, help to greatly reduce the amount of linear growth and movement (snaking) in long, straight PEX piping runs without the use of expansion loops (see **Table 9**). This applies to both horizontal and vertical applications.

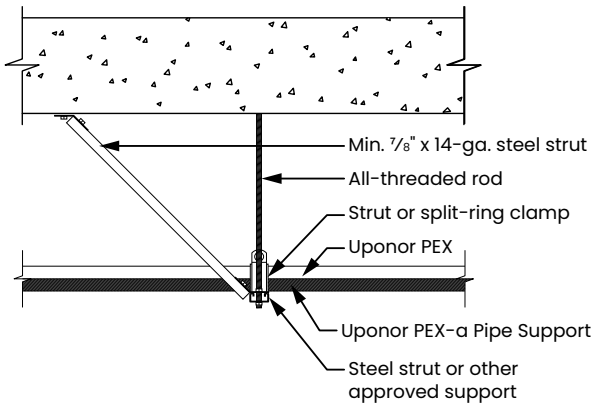
Nominal pipe size tested	Delta T ( $\Delta T$ ) <sup>1</sup>	Length of run (feet)	PEX-a Pipe Support	Support spacing (feet)	Clamp spacing (feet)	Fixed point spacing (feet)	Measured linear expansion (inches)	Coefficient of linear expansion (inches/ $10^{\circ}\text{F } \Delta T/100$ feet) <sup>*</sup>
1"							0.63	0.032
1½"	100°F	200	Yes	8	32	195	2.16	0.108
3"							5.12	0.256

**Table 9: Test results for Uponor PEX in suspended horizontal applications**

<sup>1</sup>Delta T is the temperature difference between the ambient temperature of the space and the fluid operating temperature.

<sup>\*</sup>For reference, the coefficient of linear expansion for copper tubing is 0.11"/ $10^{\circ}\text{F } \Delta T/100$  feet.





**Figure 56: Fixed point**

## **Linear expansion and contraction in underground applications**

For direct-burial applications, mitigate the effects of linear expansion with a proper installation that provides adequate resistance to axial stress. Per PPI TR-21 *Thermal Expansion and Contraction in Plastic Piping Systems*, restrain a buried or concrete-encased pipe from both lateral and axial movement with surrounding embedment material. The magnitude of the frictional restraining force is dependent on the nature of the soil and on the installation and operating conditions.

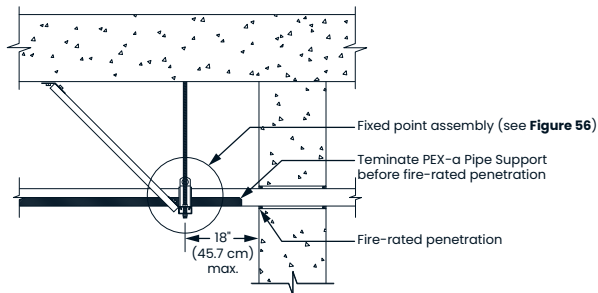
For example, the extent of compaction near the pipe can affect the quality of contact between the pipe and surrounding soil. The anchoring or restraining effect of surrounding soil on pipe movement can be significantly augmented by external pipe geometry. Tees, lateral connections and changes in direction all help to anchor a pipe in the surrounding soil.

## **Linear expansion/contraction and fire-rated penetrations**

To protect the integrity of both horizontal and vertical fire penetrations, fixed points should be used to help minimize pipe movement through the penetration. This applies to 1¼" and larger PEX pipes with a  $\Delta T$  greater than 40°F (22.2°C). See **Figures 57, 58, and 59**.

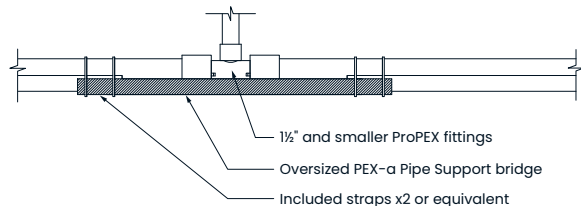
Note that this applies primarily to assemblies utilizing intumescent caulking.

Certain assemblies and cast-in-place devices, such as the HILTI CP 680-P, are designed to allow some movement, while still maintaining the assembly's integrity. Refer to the respective fire-stop manufacturer's information regarding allowable pipe movement.



**Figure 57: Fixed points near a fire-rated penetration (horizontal)**

**Note:** Fixed point is only required on one side of the penetration.



**Figure 58: Fitting bridge**

## ASTM E84 requirements for PEX-a Pipe Support

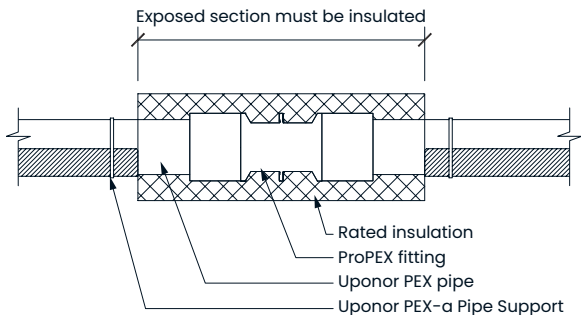
Uponor PEX-a Pipe Support is tested and approved for use in ASTM E84 applications. To meet the requirements, install PEX-a Pipe Support per the following requirements:

- Pipe or fittings without PEX-a Pipe Support shall be covered with a minimum  $\frac{1}{2}$ " (13 mm) thick insulation.
- There is no minimum segment length of PEX-a Pipe Support.

When installed per the above requirements, there are no spacing limitations between parallel piping runs.

**Note:** The above requirements also apply to PEX-a Pipe Support installed in a vertical position for ASTM E84 applications.

**Note:** Exposed sections of  $\frac{1}{2}$ " and  $\frac{3}{4}$ " Uponor PEX pipe can be installed un-insulated if the pipe runs are separated by a minimum of 18" (45.7 cm).



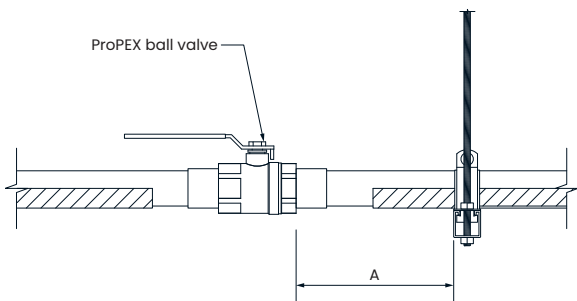
**Figure 59: PEX-a Pipe Support installations in ASTM E84 applications**

## Supporting large-diameter valves

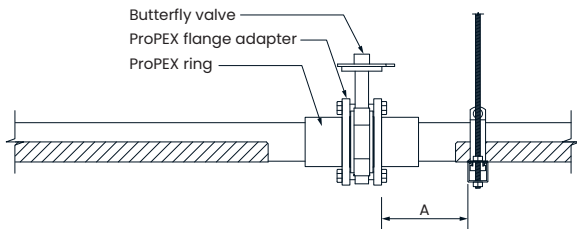
Nominal pipe size	Valve-type	Maximum support distance "A"
1¼" - 2"	Ball	18" (45.7cm)
2½" - 3"	Butterfly	7" (17.7cm)

**Table 10: Support requirements for large-diameter valves**

**Note:** For ball valves larger than 2", support within 7" (17.7 cm).



**Figure 60: Supporting 1¼" to 2" ball valves**



**Figure 61: Supporting 2½" to 3" butterfly valves**

## Vertical support requirements

Vertical runs of pipe fall into two categories: in wall and risers. For general support requirements by code, refer to **Table 5**.

In-wall piping is typically smaller in diameter (<1"), and does not pass through multiple stories like a riser. It is most often the dedicated supply piping to the fixture.

Riser piping is typically larger in diameter (>1") and passes through multiple stories, often requiring fire-penetration sealants.

**Note:** The two categories above are not mutually exclusive. Use best judgment when determining which supports are necessary.

## Vertical expansion and contraction mitigation

To help minimize expansion and contraction in vertical applications and protect the integrity of fire-penetrations, Uponor recommends the methods set forth in **Table 11**. These are in addition to the code minimums shown previously in **Table 5**.

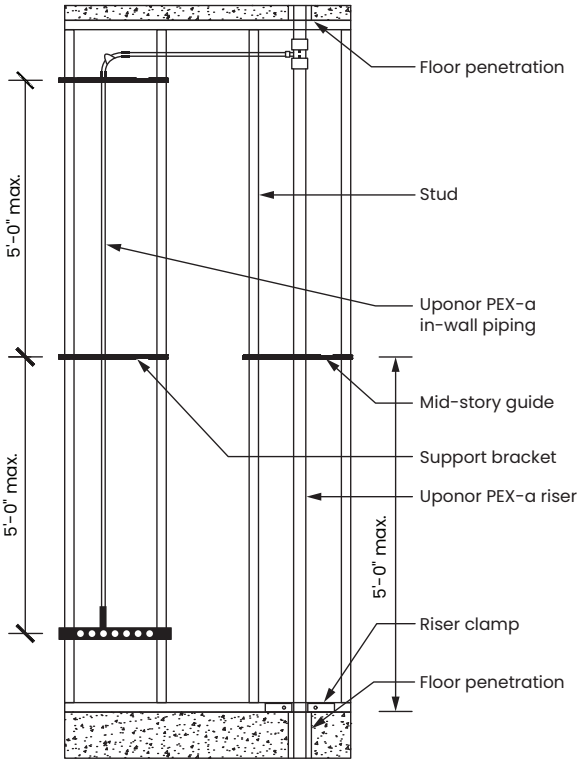
**Note:** PEX-a Pipe Support may be used in vertical applications to help reduce expansion/contraction and maintain alignment, but its use does not eliminate the need for fixed points and mid-story guides.

System type	Additional support recommendations
$\Delta T$ less than or equal to 40°F (22.2°C) (e.g. domestic cold water; chilled water) <sup>1</sup>	N/A
$\Delta T$ greater than 40°F (22.2°C) (e.g. domestic hot water; domestic hot water return; heating hot water) <sup>1</sup>	Fixed-point at the first floor penetration and every third floor thereafter <sup>2</sup> (see <b>Figures 63</b> and <b>64</b> )

**Table 11: Minimizing expansion and contraction for vertical piping**

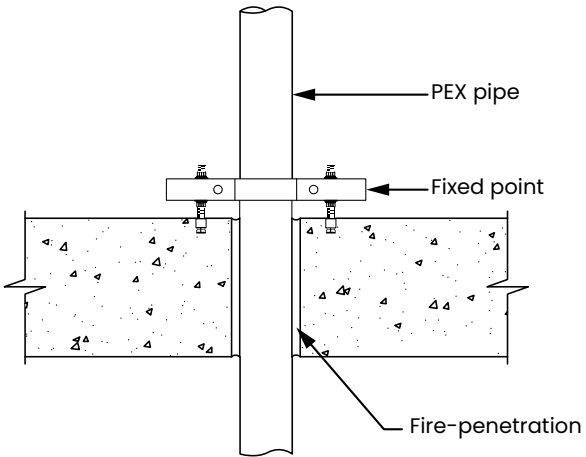
<sup>1</sup> System examples are for reference only. Delta T ( $\Delta T$ ) shall determine actual support requirements.

<sup>2</sup> Based on internal testing, this limits linear expansion to approximately 0.5" (1.27 cm) over 30 feet (2" PEX at a 100°F  $\Delta T$ ).

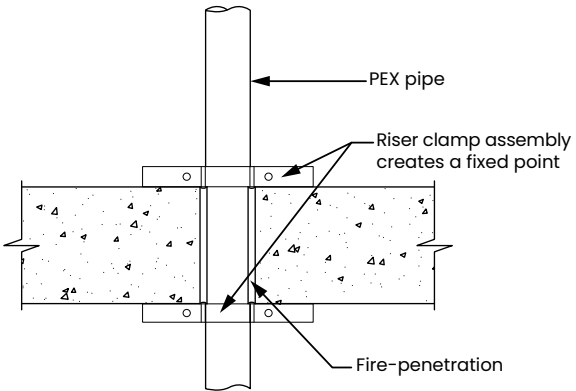


**Figure 62: In-wall versus riser piping**

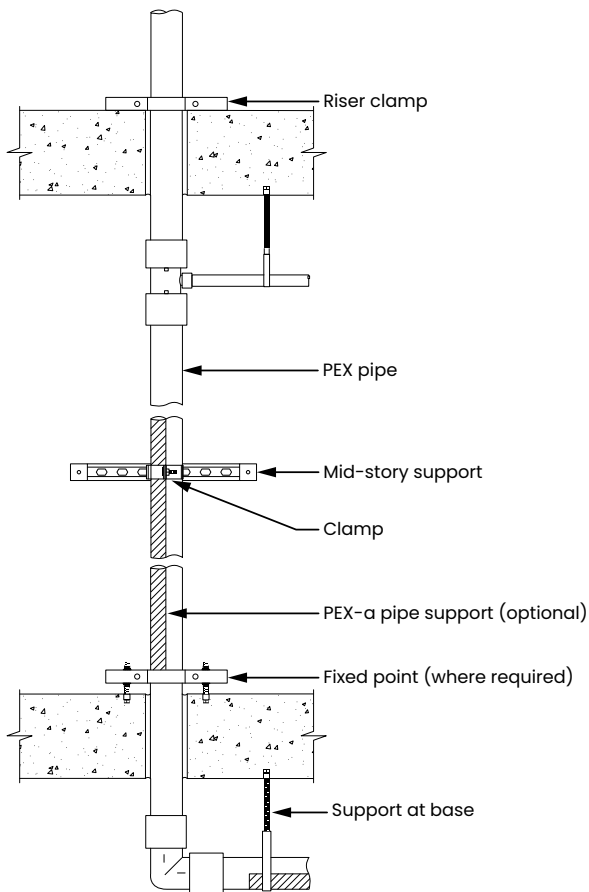




**Figure 63: Fixed point example 1 (vertical)**



**Figure 64: Fixed point example 2 (vertical)**



**Figure 65: PEX riser detail**

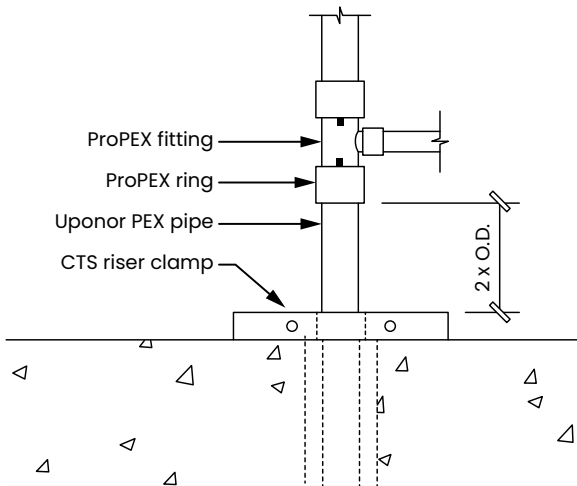
**Note:** PEX-a Pipe Support must not pass through the fire penetration, unless approved by the authority having jurisdiction (AHJ).

## Protection of ProPEX fittings from clamps

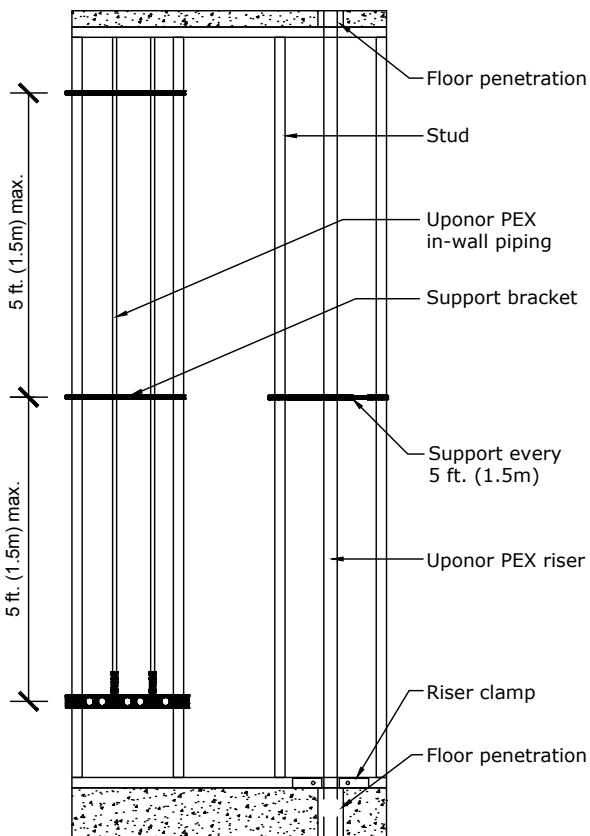
To prevent damage to ProPEX fittings, Uponor recommends the following minimum distances between clamps and ProPEX fittings.

Nominal pipe size	2 x O.D.
½"	1¼" (32 mm)
⅝"	1½" (38 mm)
¾"	1¾" (44 mm)
1"	2¼" (57 mm)
1¼"	2¾" (70 mm)
1½"	3¼" (83 mm)
2"	4¼" (108 mm)
2½"	4¾" (133 mm)
3"	6¼" (159 mm)
4"	8¼" (210 mm)

**Table 12: Distance to clamps**



**Figure 66: Clamp distance example**



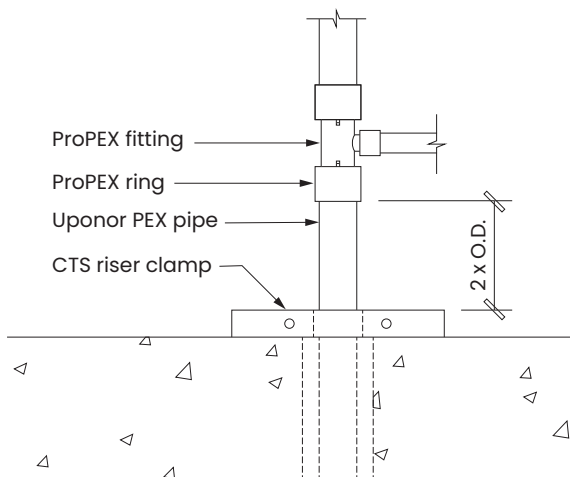
**Figure 67: In-wall versus riser piping**

### Riser clamps

To prevent damage to ProPEX fittings, Uponor recommends the following minimum distances between riser clamps and ProPEX fittings.

Nominal pipe size	2 x O.D.
½"	1¼" (32mm)
⅝"	1½" (38mm)
¾"	1¾" (44mm)
1"	2¼" (57mm)
1¼"	2¾" (70mm)
1½"	3¼" (83mm)
2"	4¼" (108mm)
2½"	4¾" (133mm)
3"	6¼" (159mm)
3½"	7¼" (184mm)
4"	8¼" (210mm)

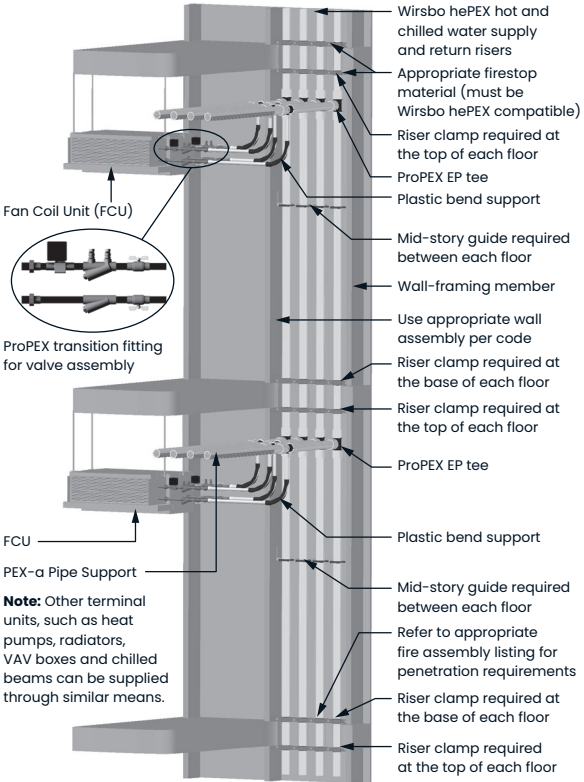
**Table 13: Distance to clamps**



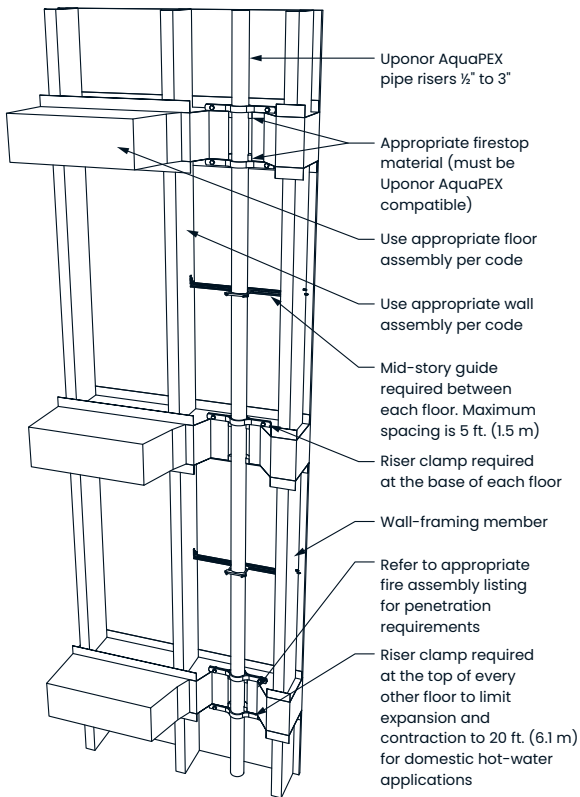
**Figure 68: Riser clamp detail**

## Risers

Vertical piping runs must comply with support spacing as defined by code. Best practice is to use the floor/ceiling assembly as a fixed point for controlling expansion and contraction by means of riser clamps.



**Figure 69: Hydronic piping riser detail**



**Figure 70: Domestic hot-water riser detail**

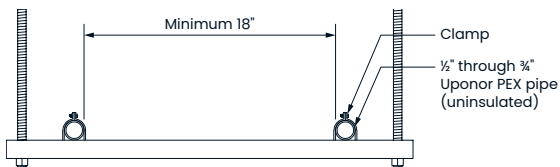


## Fire-resistant construction

The following requirements are for Uponor products installed in return-air plenum spaces.



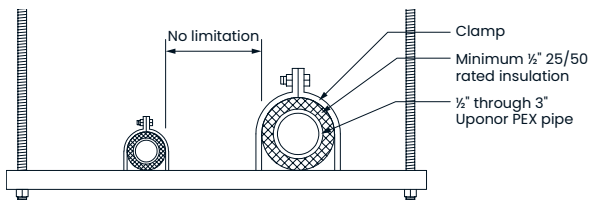
### United States — ASTM E84



**Figure 71: QAI P321-1**

Guidelines: ½" through ¾" (uninsulated)

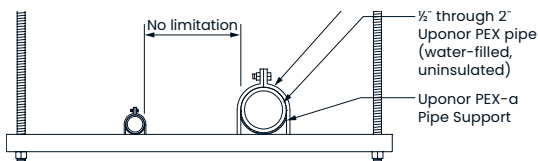
Limitations: Adjacent runs shall be located at least 18" (45.7 cm) apart.



**Figure 72: QAI P321-1**

Guidelines: ½" through 3" (insulated)

Limitations: ½" minimum thickness insulation as specified in **Table 14**.

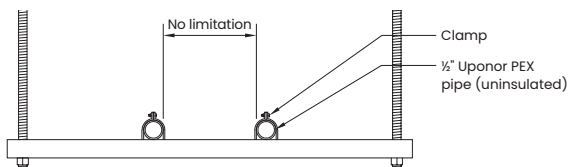


**Figure 73: QAI P321-2**

Guidelines: ½" through 3" (PEX-a Pipe Support)  
 Limitations: Pipe or fitting sections without PEX-a Pipe Support must be covered with a rated insulation per **Table 14**. There is no minimum length of PEX-a Pipe Support segments

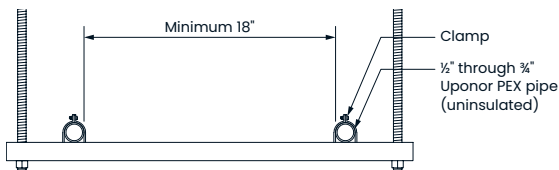


**Canada – CAN/ULC-S102.2**



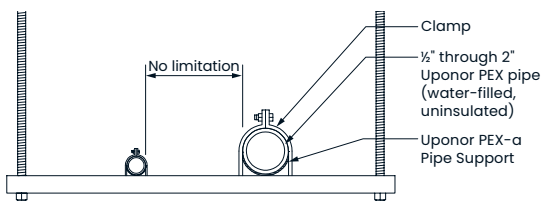
**Figure 74: QAI P321-1**

Guidelines: ½" (uninsulated)  
 Limitations: No spacing limitations.



**Figure 75: QAI P321-1**

Guidelines: ¾" and 1" (uninsulated)  
 Limitations: Adjacent pipe runs shall be located at least 18" (45.7 cm) apart.

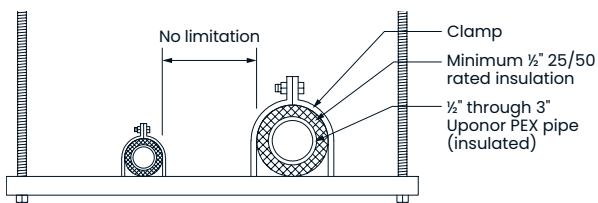


**Figure 76: QAI P321-3**

Guidelines: ½" through 2" (water-filled)

Limitations: No spacing limitations.

**Canada – CAN/ULC-S102.2**



**Figure 77: QAI P321-1**

Guidelines: ½" through 3" (insulated)

Limitations: ½" minimum thickness insulation as specified in **Table 14**.

## Specifications for pipe insulations in ASTM E84 and CAN/ULC-S102.2 applications

Products (minimum thickness)	ASTM E84 and CAN/ULC-S102.2		Density of insulation
	Flame spread	Smoke developed	
½" Manson Alley-K Fiberglass Pipe Insulation	25 or less	50 or less	4.0 pcf
½" Armaflex Composite Pipe Insulation	25 or less	50 or less	3.0 pcf
½" Johns Manville Micro- Lok Fiberglass Pipe Insulation	25 or less	50 or less	3.3 pcf
½" Johns Manville Micro-Lok HP	25 or less	50 or less	3.5 pcf
½" Owens Corning VaporWick Pipe Insulation	25 or less	50 or less	4.0 pcf
½" Owens Corning Fiberglass Pipe Insulation	25 or less	50 or less	3.5 pcf
½" Knauf Earthwool Redi-Klad Pipe Insulation	25 or less	50 or less	3.8 pcf
½" GLT Pipe and Tank Insulation	25 or less	50 or less	4.5 pcf
½" Nomalock Pipe Insulation*	25 or less	50 or less	4.0 pcf

**Table 14: Specifications for pipe insulations in  
ASTM E84 and CAN/ULC-S102.2 applications**

\*Check the rated grade of Nomalock insulations for plenum use.



## ASTM E814 and CAN/ULC-S115 listings

■ = ASTM E814 and CAN/ULC-S115

■ = CAN/ULC-S115 only

Assembly types		Manufacturer							
		3M™		Hilti®		RectorSeal®		STI	
		Wall	Floor/clg	Wall	Floor/clg	Wall	Floor/clg	Wall	Floor/clg
Wood-stud/steel-stud assemblies	1-hour	PHV-120-04	F-C-2039	W-L-2186	F-C-2081	W-L-2342	F-C-2298	F-C-2319	F-C-2032
		PHV-120-11	F-C-2240	W-L-2235	F-C-2230	W-L-2262	F-C-8015	W-L-2100	F-C-2252
		W-L-2091	F-C-2343	W-L-2466	F-C-2310	W-L-2373	F-C-2329	W-L-2144	F-C-2319
		W-L-2146	F-C-2344	W-L-2474	F-C-2334	W-L-2430	F-C-2212	W-L-2241	F-E-2003
		W-L-2173	F-C-2391	W-L-2480	F-C-8038	W-L-2526	F-E-2007	W-L-2242	F-C-8021
		W-L-2448	F-E-2002	W-L-2537	F-C-8044	W-L-2121	F-C-2221	W-L-2423	F-C-8029
		W-L-2483	F-E-2012	W-L-2467	F-C-2416	W-L-2209	F-C-2385	W-L-2508	F-E-8003
		W-L-2543	F-E-2040	W-L-5224		W-L-2528		W-L-2548	F-C-8045
		W-L-2547	PHV-120-04	W-L-2671		W-L-2402		W-L-2549	F-E-8010
		W-L-2299	PHV-120-11	W-L-2057		W-L-2638		W-L-7193	
		PV-60-02				W-L-2639		F-C-8021	
						W-L-2007		F-C-8029	
						W-L-2170		W-L-5290	
						W-L-2287		W-L-2631	
						W-L-2457			
						W-L-2524			
				W-L-2594					
				W-L-2595					

**Table 15a: Fire assemblies per manufacturer**

**Note:** This table is not meant to address every compatible fire assembly or firestop manufacturer. It is the end user's responsibility to ensure that the fire assembly

documentation being used is approved and current for the specific application. Please refer to the respective manufacturer's website for detailed listing information.

## ASTM E814 and CAN/ULC-S115 listings

■ = ASTM E814 and CAN/ULC-S115

■ = CAN/ULC-S115 only

Assembly types		Manufacturer							
		3M™		Hilti®		RectorSeal®		STI	
		Wall	Floor/clg	Wall	Floor/clg	Wall	Floor/clg	Wall	Floor/clg
Wood-stud/steel-stud assemblies	2-hour	PHV-120-04	PHV-120-04	W-L-2186	F-C-2081	W-L-2342	F-C-2221	W-L-2100	
		PHV-120-11	PHV-120-11	W-L-2235	F-C-2310	W-L-2262	F-C-2385	W-L-2144	
		W-L-2090		W-L-2466		W-L-2373		W-L-2241	
		W-L-2091		W-L-2474		W-L-2430		W-L-2242	
		W-L-2146		W-L-2480		W-L-2526		W-L-2423	
		W-L-2448		W-L-2537		W-L-2121		W-L-2508	
		W-L-2483		W-L-2467		W-L-2209		W-L-2548	
		W-L-2543		W-L-5224		W-L-2528		W-L-2549	
		W-L-2547		W-L-2671		W-L-2402		W-L-7193	
		W-L-2299				W-L-2638		W-L-5290	
						W-L-2639		W-L-2631	
						W-L-2170			
						W-L-2287			
						W-L-2457			
						W-L-2524			
				W-L-2594					
				W-L-2595					

**Table 15b: Fire assemblies per manufacturer**

**Note:** This table is not meant to address every compatible fire assembly or firestop manufacturer. It is the end user's responsibility to ensure that the fire assembly

documentation being used is approved and current for the specific application. Please refer to the respective manufacturer's website for detailed listing information.

## ASTM E814 and CAN/ULC-S115 listings

■ = ASTM E814 and CAN/ULC-S115

■ = CAN/ULC-S115 only

Assembly types		Manufacturer								
		3M™		Hilti®		RectorSeal®		STI		HOLDRITE
		Wall	Floor/clg	Wall	Floor/clg	Wall	Floor/clg	Wall	Floor/clg	Floor/clg
Concrete assemblies	1-hour					C-AJ-2605	C-AJ-2605			
	2-hour	C-AJ-2510	C-AJ-2510	C-AJ-2170	C-AJ-2170	W-J-2162	C-AJ-2628	W-J-2021	C-AJ-2031	F-A-2188
		C-AJ-2536	C-AJ-2536	C-AJ-2407	C-AJ-2407	W-J-2122	F-A-2171	W-J-2043	C-AJ-2140	F-A-2221
		PHV-120-04	F-A-2115	C-AJ-2647	C-AJ-2647	W-J-2180	C-AJ-2701	W-J-2076	C-AJ-2291	F-B-2042
		PHV-120-11	PH-120-10	W-J-2207	C-AJ-2674	W-J-2025	C-AJ-2176	W-J-2077	F-A-2186	F-A-2269
		C-AJ-2213	PHV-120-04	W-J-2229	F-B-2040	C-AJ-2628	F-A-2235	W-J-2232	F-A-2224	F-A-2222
		C-AJ-2378	PHV-120-11	W-J-2206	F-B-2041	C-AJ-2679	F-A-2237	W-J-2233	F-A-2225	F-A-2037
		W-J-2231	C-AJ-2076	W-J-5122	F-A-2142	C-AJ-2701	C-AJ-2494	W-J-5148	C-AJ-2586	
		W-J-2110	C-AJ-2213	W-J-2321	W-J-2071	W-J-2295	C-AJ-2679	C-AJ-2586	C-AJ-5345	
		C-AJ-2213	C-AJ-2378			W-J-2296	C-AJ-2702	C-AJ-5345	C-BJ-2046	
		C-AJ-2378	C-AJ-2213			C-AJ-2702		C-BJ-2046		
		C-AJ-2738	C-AJ-2378			C-AJ-2176		W-J-2291		
		PHV-120-12	C-AJ-2738			C-AJ-2494				
		C-AJ-2698	PHV-120-12			W-J-2035				
			C-AJ-2698			W-J-2051				
						W-J-2142				
						W-J-2197				
						W-J-2220				

**Table 16a: Fire assemblies per manufacturer**

**Note:** This table is not meant to address every compatible fire assembly or firestop manufacturer. It is the end user's responsibility to ensure that the fire assembly

documentation being used is approved and current for the specific application. Please refer to the respective manufacturer's website for detailed listing information.



## ASTM E814 and CAN/ULC-S115 listings

■ = ASTM E814 and CAN/ULC-S115

■ = CAN/ULC-S115 only

Assembly types		Manufacturer								
		3M™		Hilti®		RectorSeal®		STI		HOLDRITE
		Wall	Floor/clg	Wall	Floor/clg	Wall	Floor/clg	Wall	Floor/clg	Floor/clg
2-hour					W-J-2222					
					W-J-2224					
					W-J-2266					
3-hour			C-BJ-2028	C-BJ-2028	C-AJ-2119	C-AJ-2119	C-AJ-2671	C-AJ-2671	F-A-2176	
			C-BJ-2040	C-BJ-2040	C-AJ-2194	C-AJ-2194	C-AJ-5344	C-AJ-5344	F-A-2221	
			C-BJ-2041	C-BJ-2041	C-AJ-2622	C-AJ-2622	C-AJ-5346	C-AJ-5346	F-B-2042	
								C-AJ-2578	F-A-2269	
								F-A-2203	F-A-8034	
								F-A-2204	F-A-2222	

**Table 16b: Fire assemblies per manufacturer**

**Note:** This table is not meant to address every compatible fire assembly or firestop manufacturer. It is the end user's responsibility to ensure that the fire assembly

documentation being used is approved and current for the specific application. Please refer to the respective manufacturer's website for detailed listing information.

## **Below-grade and in-slab installation**

Alternative methods to overhead piping include below-grade and in-slab piping. In these installations, the pipe is laid in a trench or secured to steel-reinforcing bar (rebar) or wire mesh and routed to the desired locations. The piping system is pressurized (usually 20 psi above working pressure) and buried. Because PEX piping is available in long, continuous lengths, it is an ideal material for running below grade or in-slab without fittings. (See **pages 84 to 85** for proper trench preparation.) Always follow local code when burying Uponor PEX pipe as some jurisdictions require additional sleeving and protection.

### **Fittings for below-grade and in-slab**

Uponor EP and LF brass fittings are all approved for use in below-grade and in-slab applications. Uponor recommends EP fittings for in-slab applications where required.

Uponor LF brass fittings are approved for direct burial in soil per NSF/ANSI Standard 14 testing which established minimum performance criteria for dezincification resistance (DZR) and stress-corrosion cracking (SCC) resistance for PEX fittings intended for potable water.

**Note:** Uponor recommends wrapping LF brass fittings with a minimum 6-mil poly wrap.

**Note:** Uponor brass (non-LF) fittings are not approved for direct burial.

## **Termiticides and pesticides**

Uponor PEX piping is approved for installation directly in soil (below-grade) or in concrete (in-slab) where water-based termiticide/pesticide treatment is required. Note that Uponor PEX is only approved for use with water-based treatment products. Do not use organic solvent-based (petroleum solvent-based) products with Uponor PEX.

## **Pre-insulated Uponor PEX piping**

Pre-insulated Uponor PEX piping is approved for use in below-grade and in-slab applications. For below-grade applications, Uponor recommends the use of pre-insulated PEX with a minimum 1"-thick insulation due to static soil loads.

Protect piping where it enters and exits a concrete slab with 0.025" (0.064 mm) thick protective material, such as HDPE wrapping, closed-cell pipe insulation, PVC elbows and sleeves or equivalent, that allow expansion and contraction of the piping. Ensure proper placement where piping exits the slab. These products are described as slab-penetration protection devices.

## **Pre-sleeved Uponor PEX piping**

When using pre-sleeved Uponor PEX piping or a protection sleeve, an annular gap between these protection devices and the PEX piping will exist. In such installations, fill the annular gap between the protection device and

the PEX piping at the exposed ends to help prevent pathways for pests and the mistaken application of harmful chemicals into the space between the PEX piping and the protection device. Use only sealants that are compatible with PEX piping.

**Note:** The following products are appropriate for use when sealing PEX piping and slab-penetration protection devices:

- Latex caulk
- Latex foam
- Silicone sealant
- Polyurethane expanding foam

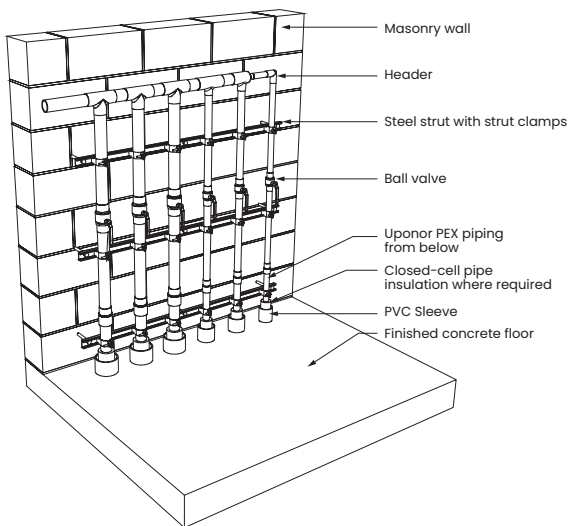
**Note:** Misapplication of these products could result in pooling or puddling of the products around the PEX piping, which is prohibited.

**Caution:**

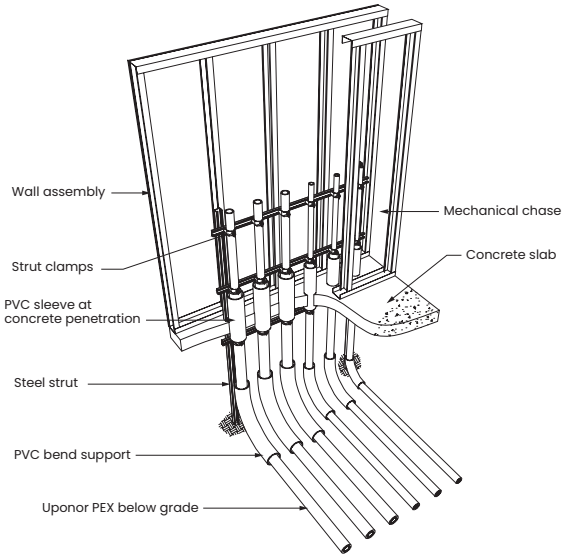
- If applying termiticides/pesticides while the installed PEX piping still has exposed open ends that are not yet connected to plumbing fixtures, cap, plug or close the ends of the piping to prevent these chemicals from entering the piping.
- Do not allow organic (petroleum-based) chemicals, petroleum distillates, termiticides or pesticides to come into direct contact with PEX piping.
- Fill the annular gap between PEX piping and slab-penetration protection devices (sleeving or PVC bend guides) at the ends of the piping

to help prevent pathways for pests and the mistaken application of harmful chemicals into the space between the PEX piping and the protection device. Use only sealants that are compatible with PEX piping.

- When PEX piping is continuously sleeved below or above a slab (such as when using pre-sleeved Uponor PEX piping), never fill the space between the PEX piping and the sleeving with any liquid chemical, including pesticides or termiticides. Prevent pooling or puddling of these liquids around PEX piping.
- When it is necessary to re-treat soil near PEX piping, prevent the puddling or pooling of the termiticide/pesticide.



**Figure 78: Mechanical room transition (below-grade piping)**



**Figure 79: Wet-wall chase transition (below-grade piping)**



**Figure 80: Uponor PEX below grade**

## Water service

Uponor ServicePEX™ pipe is manufactured and designed for use in water service applications. The pipe is certified to the AWWA C904 Standard and is listed to IPC, IRC, and UPC requirements.

The pipe has the following hydrostatic **ratings** per **PPI TR-4**:

- 160 psi at 73°F (11 bar at 23°C)
- 100 psi at 180°F (6.9 bar at 82°C)

**Note:** ServicePEX can satisfy the **performance requirements** of section F.7 of PPI **TR-3** for polyethylene (PE) materials to qualify for a **higher 0.63 design factor** resulting in a hydrostatic temperature/pressure rating of **200 psi at 73.4°F (13.8 bar at 23°C)**.

Note that while the pipe features a PEX 5306 marking for six months of UV resistance, the pipe has been **tested** and **proven** to withstand **12 months of UV exposure**.



**Figure 81: Uponor ServicePEX pipe**

## **Compression fittings**

Use only SDR9 compression fittings listed in compliance with AWWA C800 as referenced in AWWA C904 for water service applications when transitioning from curb stops or corporation stops to Uponor PEX piping. Be sure to use insert stiffeners when assembling a compression fitting with PEX. Commonly available SDR9 compression fitting manufacturers include:

- Ford Meter Box Company, Inc.®
- Mueller Company®
- A.Y. McDonald Mfg. Co.®
- Philmac®

For  $\frac{5}{8}$ " to 1" water meter connections, Uponor offers direct ProPEX to NPSM swivel adapters in straight, elbow, and valved configurations. Refer to the Uponor Product Catalog for more information.

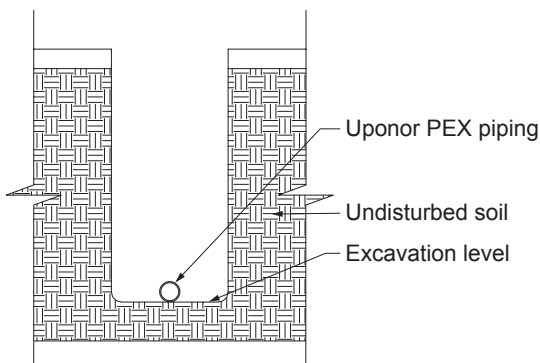
## **Trace wire**

Uponor recommends the use of trace wire to facilitate the detection of underground pipe systems. Trace wire should be 14-gauge minimum solid copper with thermoplastic insulation suitable for direct burial. Refer to local code for further requirements.

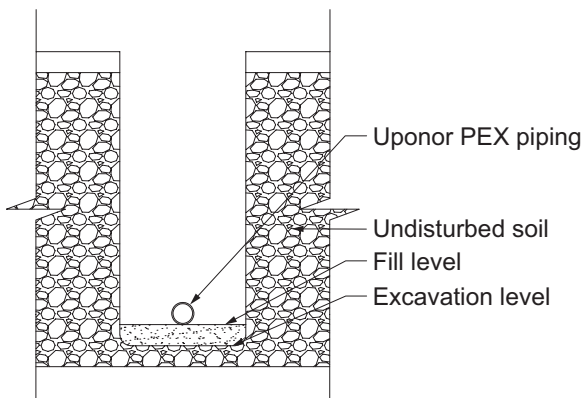
## **Trench bottom preparation**

To achieve a satisfactory installation, it is essential that the soil provides stable and continuous support for the piping.





**Figure 82: Good soil conditions** — If the trench is dug smoothly, install the piping directly on the prepared bottom. The bottom must be flat with no hollows, lumps or rocks.



**Figure 83: Poor soil conditions** — With rocky, clay, muddy or other poor soil conditions, it may be necessary to prepare the trench bottom using granular material of such size and grading to provide a stable base. See local code for additional requirements.

## **Piping embedment**

Proper soil selection, placement and compaction are essential in the area around the piping. Backfill around the piping with sand or gravel that has a maximum particle size of  $\frac{3}{4}$ ".

Compact the initial backfill around the piping to provide adequate piping support and prevent settling. It is particularly important to adequately compact the soil around the tap connection. Uponor recommends pressurizing the piping prior to backfilling to reveal any damage. In heavy vehicular traffic areas, compact backfill to 90 percent of maximum soil density.

Do not use highly plastic clays, silts, organic materials, or sharp or large rocks as backfill in the immediate vicinity of the piping. Compact the backfill from the subgrade to a level per local code that will cover the piping 4" to 6" to provide protection around the piping and to prevent settling that puts stress on the fittings and the piping.

## **Installation**

Install Uponor PEX piping underground in a manner that ensures external loads will not subsequently cause a decrease in the vertical dimension of the cross section of the piping that exceeds 5 percent of the outside diameter. Install Uponor PEX piping in a snaking pattern with sufficient slack in the line to allow for contraction of the line due to temperature change prior to backfilling. The linear expansion rate for Uponor PEX piping is approximately

1.1" per 10°F temperature change per 100 ft. of piping (27.94 mm per 5.56°C temperature change per 30.48 m of piping).

**Note:** Do not use blocking to support the piping or change the piping grade. Do not install potable-water service piping in, under or above cesspools, septic tanks, septic-tank drainage fields or pits.



**Caution:** Do not install Uponor PEX piping in soil environments contaminated with solvents, fuels, organic compounds, pesticides or other detrimental materials that may cause permeation, corrosion, degradation or structural failure of the piping. In areas where such conditions are suspected, perform a chemical analysis of the soil or groundwater to ascertain the acceptability of Uponor PEX piping for the specific installation. Check local codes for additional requirements.

## Handling and repairs

Although Uponor PEX piping is highly resistant to kinking and abrasion, take care while handling and installing the piping to prevent damage and possible failure of the piping. If damage occurs during installation, cut out the damaged area and repair before backfilling.

To reform kinked piping, see “Reforming kinked piping” on **page 27**. If the piping is damaged beyond its thermal-memory capacity, use a ProPEX coupling. Do not reuse or reclaim EP fittings.

## **Horizontal directional drilling (HDD)**

Horizontal directional drilling is used when trenching or excavation is not practical. A surface-launched drilling rig provides a steerable, trenchless method of installing underground pipes along a shallow arc bore path, resulting in minimal impact to surrounding areas. It is suitable for a variety of soil conditions.

HDD is further categorized into the following types:

- Mini-HDD
  - Distances less than 600 ft.
  - Depths up to 15 ft.
  - Pipe diameters up to 12"
- Equipment pullback capability of up to 20,000 lbs. and torque less than 950 ft-lbs.
- Maxi-HDD
  - Distances greater than 600 ft.
  - Depths up to 200 ft.
  - Pipe diameters up to 48"
  - Equipment pullback capability of up to 100,000 lbs. and torque up to 80,000 ft-lbs.

## **Criteria for Uponor PEX piping in HDD applications**

- Use Uponor PEX only as the follow pipe.
- Take precautionary steps to ensure piping does not come in contact with sharp objects.
- Do not exceed minimum bend radius of 6 times the O.D. of the piping.
- Pressure test installed piping after installation to ensure the integrity of the piping has not been compromised.

For HDD applications using Uponor PEX piping, reference PPI TR-46 *Guidelines for Use of Mini-Horizontal Directional Drilling for Placement of High Density Polyethylene Pipe*.

SDR9 Uponor PEX 12-hour pull		
Nominal pipe size	Tensile yield design (safety) factor	Allowable tensile load at 73°F/22.8°C - lbs (N)
½"	0.4	128 (569)
¾"	0.4	248 (1,103)
1"	0.4	411 (1,828)
1¼"	0.4	615 (2,735)
1½"	0.4	859 (3,821)
2"	0.4	1,465 (6,516)
2½"	0.4	2,239 (9,960)
3"	0.4	3,169 (14,096)

**Table 17: Safe pull force**

**Note:** The method set forth in ASTM F1804 determines the allowable tensile load.

## Pressure testing

### Residential applications

1. Pressurize system to 25 psi (1.7 bar) above working pressure or 100 psi (6.9 bar).
2. Test in accordance with local code.

### Commercial applications

1. Visually confirm all connections are properly made per Uponor installation guidelines.

2. Ensure that all components, fixtures and equipment not rated for the test pressure are isolated from the test system.
3. Ensure that all other thermoplastic piping materials are isolated from the test system.
4. Fill the system with potable water, air or a mixture of both.
5. Condition the system to 1.5 times the required test pressure for 30 minutes. This will require constant pumping or cycling the valve and compressor to maintain a pressure of 1.5 times the test pressure. If cycling the valve and compressor, apply additional pressure once the psi has dropped 10 psi (0.7 bar).
6. After conditioning the system for 30 minutes, quickly relieve excess pressure by opening the valve. Close the valve when the system has reached the desired test pressure.

**Note:** Uponor recommends a test pressure of 80 psi (5.5 bar) (unless local code dictates higher pressures).

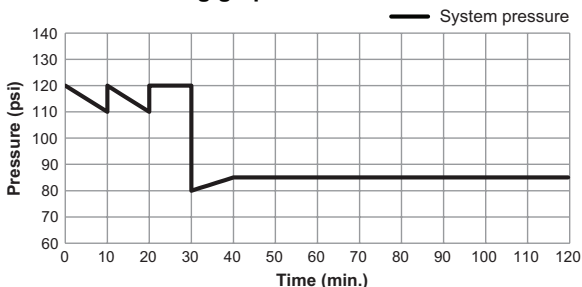
7. Once the valve is closed, confirm a slight rise in pressure 3 to 6 psi (0.2 to 0.4 bar). This increase will occur as the pipe's I.D. is shrinking from its conditioned state to equalize at the lower pressure.
8. Visually check for leakage and monitor the pressure for the duration specified by local code. (A typical pressure test can range from 2 to 24 hours).
9. If there is no reduction in pressure, the system is regarded as leak tight.

**Note:** Slight fluctuations of pressure are normal due to ambient temperature changes, especially during long durations (e.g., 24 hours).

10. Flush the system as required by code.

**Note:** If using water to pressure test the system, purge all water from the system prior to the ambient air temperatures falling to 32°F (0°C). Failing to remove the water from the system can result in damage to the piping and associated equipment.

### Pressure testing graph



**Figure 84: Pressure testing graph**

## System flushing

Uponor **recommends flushing** the plumbing system and all potable water fixtures with fresh, potable water prior to occupancy. Consult local codes as additional requirements may apply.

## Water system disinfection

**When system disinfection is required,** treatment can be accomplished through thermal or chemical disinfection methods.



**Thermal disinfection** – For “thermal disinfection”, raise the hot-water temperature to 160°F (71°C) and maintain while flushing for a minimum of five minutes, not to exceed 24 hours on a monthly basis. Care should be taken to prevent scalding at elevated temperatures.

**Chemical disinfection** – When adding chemicals to a plumbing system, disinfection chemicals are strong oxidizing agents and have the potential to reduce system life of the piping system. See **Table 18** for recommended maximum concentration of common chemicals used for disinfection, and corresponding duration and temperature.

**Note:** Flush the system with clean, potable water after disinfection.

Thermal and chemical disinfection treatment methods should not exceed 80 psi system pressure or the maximum guidelines stated in **Table 18**.

### **Chlorine dioxide**

Uponor **does not** recommend use of its PEX pipe and ProPEX fittings as part of any potable-water distribution system in buildings where chlorine dioxide is used for secondary disinfection or where injection systems using chlorine dioxide are present. This is based on the limited industry data available for the long-term effects of chlorine dioxide on PEX piping systems at allowable controlled levels.



## **Important system disinfection notes**

- Uponor does NOT recommend long-term or continuous-dosing chemical treatments.
- Do not use chemical disinfection/shock treatment on a monthly basis. Limit chemical disinfection to four cycles over the life of the piping system.
- Do not use especially high oxidizing agents, such as ozone, chlorine dioxide, etc.
- These guidelines are for disinfection treatment and do not supersede normal operating parameters.

These guidelines are set forth for informational purposes only, and it remains the responsibility of the facility manager, water management contractor and end-user to maintain system health and to ensure compatibility and effectiveness of the disinfection treatment with the entirety of the plumbing system.

If other treatments or chemicals not included in this document are intended for use, contact Uponor Technical Services for compatibility prior to system exposure. If necessary, have the chemical manufacturer approve the suitability of the disinfectant for all components of the plumbing system and installation.

Note that these guidelines are subject to change. Please contact Uponor Technical Services at 888.594.7726 to confirm the latest guidelines.

Chemical	Symbol	Concentration of free chlorine	Maximum	
			Duration	Temperature
Sodium hypochlorite	NaOCl	200 mg/L (ppm)	3 hours	
		50 mg/L (ppm)	24 hours	77°F (25°C)
Chlorine (liquid or gas)	Cl <sub>2</sub>	200 mg/L (ppm)	3 hours	
		50 mg/L (ppm)	24 hours	
		4 mg/L (ppm)	72 hours	140°F (60°C)
Hydrogen peroxide	H <sub>2</sub> O <sub>2</sub>	200 mg/L (ppm)	3 hours	
		50 mg/L (ppm)	24 hours	77°F (25°C)
Chloramines	NH <sub>2</sub> Cl	200 mg/L (ppm)	3 hours	
		50 mg/L (ppm)	24 hours	
		4 mg/L (ppm)	72 hours	140°F (60°C)

**Table 18: Uponor disinfection guidelines**

## Water additives

The building industry widely uses Uponor PEX-based systems in hydronic piping applications, mostly for conveying water between water heating/cooling devices (e.g., boilers, chillers) and terminal units such as fan coils. Uponor PEX pipe offers advantages such as light weight, corrosion resistance, ease-of-assembly and cost-effectiveness. In addition to Uponor PEX pipe, these applications also use various configurations of Uponor ProPEX fittings (e.g., tees, ells, couplings, etc.) made from brass or EP for connection purposes. Most hydronic piping systems incorporate metallic components supplied by third parties, which require corrosion protection. Consideration must also be given to external factors, such as temperature and induced stresses, in addition to water conditions, such as pH, impurity control, and buffering. Thus, various additives are typically added to the water being conveyed throughout hydronic piping systems. To avoid damage to Uponor PEX pipe and ProPEX fittings, all of these variables must be considered, and only additives that are chemically compatible with the Uponor components should be employed.

As a means of providing guidance in selecting an additive that is chemically compatible with Uponor PEX pipe and ProPEX fittings, we recommend that the attributes of the treated water should be in the ranges indicated in **Table 19**.

Attribute	Low	High
pH	7	9.1
Nitrite	0 ppm	≤2,000 ppm
Soluble metal – iron	0 ppm	≤ 2 ppm
Soluble metal – copper	0 ppm	≤ 1 ppm
Azole –TTA	0 ppm	≤ 100 ppm
Molybdate	0 ppm	≤ 500 ppm

**Table 19: Recommended attributes of treated water**

It is also important to give consideration when selecting a cleaning agent. Cleaning the hydronic system is common upon initial startup. With Uponor PEX-based systems, the cleaning process should:

- Not exceed 72 hours
- Use non-petroleum-based cleaners
- Not exceed a pH of 11
- Have water temperatures less than 140°F (60°C)

Prior to cleaning the hydronic system, ensure the water management contractor is informed of the above guidelines.

Note that these guidelines are subject to change. Please contact Uponor Technical Services at 888.594.7726 to confirm the latest guidelines information.

These guidelines are set forth for informational purposes only, and it remains the responsibility of the additive supplier, water management contractor, and the end-user to assure compatibility and effectiveness of the treated hydronic water with the entirety of the hydronic piping system.

## **Pipe identification**

Uponor testing allows the use of pipe tapes, adhesive tapes, and markers to identify Uponor PEX piping products.

## **Painting PEX**

It is acceptable to use latex and acrylic-based paint, such as 100 percent acrylic exterior latex house paint, with Uponor PEX. These products will not harm the molecular structure or integrity of the PEX piping or ProPEX fittings (EP or brass).

## **Operating parameters**

### **Excessive temperature and pressure capability**

In the event of an equipment or system malfunction, Uponor PEX is capable of withstanding temperatures of up to 210°F at 150 psi (99°C at 10 bar) for a maximum of 48 hours until repairs can be made.

**Note:** Excessive temperature and pressure requirements are meant solely to demonstrate that PEX piping can temporarily withstand intermittent elevated values and shall not be used as system operating parameters.

System type	Uponor PEX maximum operating parameters		
	Temperature	Pressure	Velocity
Water service piping	See <b>Table 21</b>		10 ft./sec.
Domestic cold-water piping	See <b>Table 21</b>		10 ft./sec.
Domestic hot-water piping	140°F (60°C)	80 psi (5.5 bar)	8 ft./sec.
Domestic hot-water recirculation piping (dedicated)*	140°F (60°C)	80 psi (5.5 bar)	2 ft./sec.
Heating hot-water piping	See <b>Table 21</b>		8 ft./sec.
Chilled-water piping	See <b>Table 21</b>		8 ft./sec.

**Table 20: Maximum recommended design parameters for Uponor PEX piping systems**

\*Sized per the requirements stated in ASPE Plumbing Engineering Design Handbook (PEDH), Volume 2, Plumbing Systems

**Note:** For systems requiring pressures and/or temperatures beyond the recommended values, please contact Uponor Technical Services at 888.594.7726.

<b>Hydrostatic temperature and pressure ratings*</b>	
<b>°F/°C</b>	<b>psi/bar</b>
<b>200.0/93.3</b>	<b>80/5.5</b>
190.0/87.8	90/6.2
<b>180.0/82.2</b>	<b>100/6.9</b>
170.0/76.7	106/7.3
160.0/71.1	111/7.7
150.0/65.6	117/8.0
140.0/60.0	123/8.5
130.0/54.4	128/8.8
120.0/48.9	134/9.2
110.0/43.3	139/9.6
100.0/37.8	145/10.0
90.0/32.2	151/10.4
80.0/26.7	156/10.8
<b>73.4/23.0</b>	<b>160/11.0</b>
60.0/15.6	168/11.6
50.0/10.0	173/11.9
40.0/4.4	179/12.3

**Table 21: Interpolated hydrostatic temperature and pressure ratings of Uponor PEX for water service, domestic cold water, and hydronic systems.**

\*ServicePEX can satisfy the performance requirements of section F.7 of PPI TR-3 for polyethylene (PE) materials to qualify for a higher 0.63 design factor resulting in a temperature/pressure rating of 200 psi at 73.4°F (13.8 bar at 23°C).



## Domestic hot-water recirculation operation

To provide clarity around domestic hot-water (DHW) and DHW recirculation (DHW-R) systems, refer to the following definitions along with the information in **Table 20**.

**Important:** Damage caused by improper operating conditions in DHW-R systems will **void** the Uponor **warranty**. If there are differences between Uponor recommendations and local code, always follow the more-restrictive criteria. For example, where Uponor's recommendations are more restrictive than the local code, follow the Uponor recommendations to ensure the product performs as expected and remains covered under warranty.

### DHW and DHW-R temperature

Controlling the delivered water temperature in all plumbing systems is critical to ensure system longevity, occupant health, energy efficiency, and sustainability. The following are examples for properly controlling the DHW temperature to ensure it does not exceed the maximum recommended temperature of 140°F (60°C) for Uponor AquaPEX pipe.

### Temperature dial

Tank-style water heaters come standard with a dial to set the temperature of the water in the tank. Many or most of these dials come with arbitrary markings (e.g., A, B, C, or Warm, Hot, etc.). Confirm the dial setting through a

temperature gauge installed on the outlet of the heater (hot side). Use a thermometer to measure the temperature of the water flow at the closest fixture. Allow the water to run to ensure the water sample is an accurate reflection of the tank temperature.

### **Digital control**

Devices, such as indirect water tanks or tankless water heaters, use onboard controls to manage the water temperature being supplied to the DHW system. Become familiar with these controls to properly set a reasonable, effective, and efficient temperature, which is typically 115°F (46°C) to 122°F (50°C). Confirm through the temperature display that the set temperature is not exceeded during a heat-up cycle.

### **Aquastat**

Set the aquastat dial to the desired setting based on a typical delivery temperature or design requirement. Confirm the aquastat (or tank) setting by sampling the DHW and the nearest fixture.

### **Tempering valve**

In cases where local or onboard controls cannot consistently control the desired water temperature delivery, consider installing a tempering valve to ensure operating condition.

## **Modulating valve**

Due to the size and volume needed to provide DHW to occupants in commercial structures, it may be necessary to install a modulating valve (or valves) to control the fluctuations and swings in demand for the supply water temperature.

## **System pressure**

If system pressure is not properly controlled and maintained, excessive static or fluctuating pressures can cause premature performance issues with the plumbing system, including water heaters, washing machines, dishwashers, and toilet flush valves, to name a few. The following bullets provide information regarding the origination of increased system pressures along with means to prevent or control pressure fluctuations.

- **Backflow preventers/check valves** –

When water is heated, it expands. This may increase the system water pressure above the recommended code limit of 80 psi.

In systems with no backflow preventers, volume expansion can be absorbed back into the water mains. However, a system with backflow preventers experiences the volume expansion within the plumbing system, which may increase pressures beyond the limits of the plumbing system components. Because backflow preventers are often installed in water meters and are difficult to identify, it is important to install an expansion tank in these circumstances.

- **Expansion tanks** – In accordance with most major plumbing codes in North America, systems with backflow preventers or check valves on the main water service line will require an expansion tank or other approved device to control thermal expansion. Systems using these devices are more likely to experience elevated pressures that may be above the maximum recommended limit of 80 psi due to thermal expansion of the heated water. Install expansion tanks on the cold-water supply line to the heater and size accordingly based on the water heater tank capacity. Also, refer to the water heater manufacturer's installation guidelines for expansion tanks and other similar devices.
- **Pressure-reducing valves (PRVs)** – Recent trends have seen many utilities increase the supply water pressure above 80 psi to provide service to more homes. In this case, Uponor recommends installing a pressure-reducing valve (PRV) to limit the pressure entering the plumbing system. Typical system pressurization should be between 50 and 60 psi.
- **Secondary pressure relief valves** – In situations where other methods of controlling over pressurization are not working or are not an option, install a secondary pressure-relief valve. Typical relief valves that come with water heaters are set to relieve pressure at 125 or 150 psi. A secondary relief valve set to 80 psi will ensure the system is properly protected from pressure spikes.

- **Water hammer** – Water hammer is a high pressure shockwave that spreads through a piping system when moving water is forced to stop or change direction quickly. This phenomenon happens when the domestic water system includes swing-check and fast-closing solenoid valves. Water hammer is present when there is a knocking or banging sound in the system but may not always be noticeable, depending on the piping materials installed. These spikes can damage system equipment, including pumps, appliances, gauges, etc., along with create excessive stress in the pipes, causing reduced service life. Consider installing silent or spring-assisted check valves along with water hammer arrestors. Other options for addressing water hammer include reducing the operating pressure and/or flow rate velocity or installing PRVs in the supply line.
- **Booster pumps** – Booster pumps that increase low water pressure and flow can sometimes exceed the limitations for the domestic water piping. Ensure booster pump operation does not allow the system to exceed pipe limitations.

## **Balancing valves**

Balancing valves maintain flow conditions to ensure control valves function properly. These are important to include because unbalanced systems can produce wide temperature, pressures, and velocity swings.

## Balancing DHW-R systems

DHW-R systems require flow balancing to maintain satisfactory system temperatures and flows. If systems are not properly balanced, circulated water has the tendency to short circuit through the shortest loop in the system, thus creating high velocities in that loop and resulting in hot water delays to remote loops. It is important to insulate DHW-R lines, and they typically require little flow to maintain satisfactory system temperatures. Uponor limits maximum velocity for DHW-R systems to 2 fps in dedicated hot-water return piping using Uponor PEX (see **Table 22**). For system balancing, use calibrated devices such as balancing valves or flow limiters. Consider thermostatic balancing valves with an electronically commutated motor (ECM)/variable-speed DHW return pumps. Each balancing valve requires a check valve, either inline or incorporated into the balancing valve assembly, to prevent reverse flow from fixture discharge.

Uponor recommends saving balancing reports for future review of documentation should it be needed.

Nominal pipe size	Velocity (ft./sec.)	Flow rate (gpm)	Friction loss per foot at 120°F/48.9°C
½"	2	1.1	0.0195
¾"	2	2.2	0.0126
1"	2	3.6	0.0092
1¼"	2	5.4	0.0072
1½"	2	7.5	0.0059
2"	2	12.9	0.0042
2½"	2	19.8	0.0033
3"	2	28.1	0.0026

**Table 22: Uponor AquaPEX flow rates at 2 ft./sec.**

# Appendix A: Dimensions and physical characteristics of Uponor PEX pipe

Dimensions and physical characteristics of SDR9 Uponor PEX pipe					
Nominal pipe size	Pipe O.D. (in)	Pipe I.D. (in)	Weight of pipe only lbs/ft (kg/m)	Contents of pipe gal/ft (l/m)	Weight of pipe and water lbs/ft (kg/m)
¼"	0.375	0.241	0.04 (0.018)	0.0024 (0.009)	0.06 (0.027)
⅜"	0.50	0.35	0.05 (0.022)	0.005 (0.018)	0.09 (0.040)
½"	0.625	0.475	0.06 (0.027)	0.0092 (0.034)	0.14 (0.063)
⅝"	0.750	0.574	0.08 (0.036)	0.0134 (0.050)	0.19 (0.086)
¾"	0.875	0.671	0.1 (0.045)	0.0184 (0.069)	0.25 (0.113)
1"	1.125	0.862	0.2 (0.090)	0.0303 (0.114)	0.45 (0.204)
1¼"	1.375	1.054	0.34 (0.154)	0.0453 (0.171)	0.72 (0.326)
1½"	1.625	1.244	0.44 (0.199)	0.0632 (0.239)	0.96 (0.435)
2"	2.125	1.629	0.682 (0.309)	0.1083 (0.409)	1.58 (0.716)
2½"	2.625	2.011	0.93 (0.421)	0.1649 (0.624)	2.3 (1.043)
3"	3.125	2.4	1.28 (0.580)	0.2351 (0.889)	3.24 (1.469)

**Table 23: Dimensions and physical characteristics of SDR9 Uponor PEX pipe**



## Appendix B: Hydrostatic temperature and pressure ratings

Uponor maintains standard-grade ratings for Uponor PEX piping. Uponor PEX carries the following temperature and pressure ratings shown in **Table 24**.

**Note:** Uponor EP and LF brass fittings carry the same temperature and pressure ratings as Uponor PEX pipe.

ASTM F876 temperature and pressure ratings for SDR9 PEX		
Rated temperature	Hydrostatic design stress (HDS) psi	Pressure rating for water psi
73.4°F/23°C	630	160 psi (11 bar)
180°F/82°C	400	100 psi (6.9 bar)
200°F/93°C	315	80 psi (5.5 bar)

**Table 24: Hydrostatic temperature and pressure ratings for Uponor PEX pipe**

**Note:** ServicePEX can satisfy the performance requirements of section F.7 of PPI TR-3 for polyethylene (PE) materials to qualify for a higher 0.63 design factor resulting in a temperature/pressure rating of 200 psi at 73.4°F (13.8 bar at 23°C).

## Interpolation method

Pressure ratings at different temperatures are determined by using a linear relationship between the standard-grade ratings. See **Table 25** for interpolated temperature and pressure ratings.

## Excessive temperature and pressure capability

In accordance with ASTM F876 Standard Specification for Crosslinked Polyethylene (PEX) Piping, the excessive temperature and pressure capability of Uponor PEX is 210°F at 150 psi (99°C at 10 bar).

This standard requires that Uponor PEX piping maintain its integrity for a period of 720 hours (30 days) at 210°F (99°C) at 150 psi (10 bar). If installed as directed, Uponor PEX will withstand these conditions.

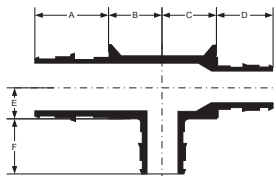
**Note:** Excessive temperature and pressure requirements are always subject to approval by local building codes (e.g., temperature and pressure-relief valves).

<b>Interpolated hydrostatic temperature and pressure ratings</b>	
<b>°F/°C</b>	<b>PSI/bar</b>
<b>200.0/93.3</b>	<b>80/5.5</b>
190.0/87.8	90/6.2
<b>180.0/82.2</b>	<b>100/6.9</b>
170.0/76.7	106/7.3
160.0/71.1	111/7.7
150.0/65.6	117/8.0
140.0/60.0	123/8.5
130.0/54.4	128/8.8
120.0/48.9	134/9.2
110.0/43.3	139/9.6
100.0/37.8	145/10.0
90.0/32.2	151/10.4
80.0/26.7	156/10.8
<b>73.4/23.0</b>	<b>160/11.0</b>
60.0/15.6	168/11.6
50.0/10.0	173/11.9
40.0/4.4	179/12.3

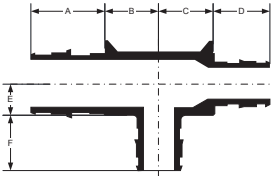
**Table 25: Interpolated hydrostatic temperature and pressure ratings for Uponor PEX pipe**

**Note:** ServicePEX can satisfy the performance requirements of section F.7 of PPI TR-3 for polyethylene (PE) materials to qualify for a higher 0.63 design factor resulting in a temperature/pressure rating of 200 psi at 73.4°F (13.8 bar at 23°C).

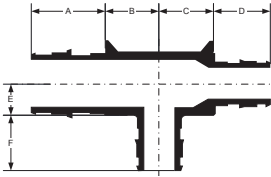
# Appendix C: ProPEX fitting dimensions



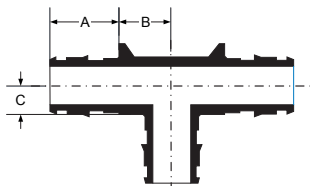
ProPEX EP reducing tees		A	B	C	D	E	F
Description	Part no.	in	in	in	in	in	in
		mm	mm	mm	mm	mm	mm
½" PEX x ½" PEX x ¾" PEX	Q4755575	¾	11/16	11/16	¾	½	15/16
		19	18	18	19	13	24
¾" PEX x ½" PEX x ½" PEX	Q4757555	15/16	11/16	11/16	¾	½	¾
		24	18	18	19	13	19
¾" PEX x ½" PEX x ¾" PEX	Q4757557	15/16	11/16	11/16	¾	½	15/16
		24	18	18	19	13	24
¾" PEX x ¾" PEX x 5/8" PEX	Q4757563	15/16	11/16	11/16	15/16	9/16	7/8
		24	18	18	24	14	22
¾" PEX x ¾" PEX x ½" PEX	Q4757550	15/16	11/16	11/16	15/16	9/16	¾
		24	18	18	24	14	19
¾" PEX x ¾" PEX x 1" PEX	Q4757710	15/16	7/8	7/8	15/16	11/16	13/16
		24	22	22	24	18	30
1" PEX x ¾" PEX x ¾" PEX	Q4751775	13/16	7/8	7/8	15/16	11/16	15/16
		30	22	22	24	18	24
1" PEX x ¾" PEX x 1" PEX	Q4751751	13/16	7/8	7/8	15/16	11/16	13/16
		30	22	22	24	18	30
1" PEX x 1" PEX x ½" PEX	Q4751150	13/16	7/8	7/8	13/16	11/16	¾
		30	22	22	30	18	19
1" PEX x 1" PEX x ¾" PEX	Q4751175	13/16	7/8	7/8	13/16	11/16	15/16
		30	22	22	30	18	24
1¼" PEX x 1" PEX x ¾" PEX	Q4751317	13/16	15/16	15/16	17/16	15/16	15/16
		30	25	25	37	24	24
1¼" PEX x 1" PEX x 1" PEX	Q4751311	17/16	15/16	15/16	13/16	15/16	13/16
		37	25	25	30	24	30
1¼" PEX x 1¼" PEX x ½" PEX	Q4751350	17/16	¾	¾	17/16	¾	¾
		37	19	19	37	19	19
1¼" PEX x 1¼" PEX x ¾" PEX	Q4751337	17/16	7/8	7/8	17/16	¾	15/16
		37	23	23	37	19	24
1¼" PEX x 1¼" PEX x 1" PEX	Q4751331	17/16	15/16	15/16	17/16	15/16	13/16
		37	25	25	37	24	30
1½" PEX x 1" PEX x ¾" PEX	Q4751517	11/16	13/16	13/16	13/16	17/16	15/16
		43	30	30	30	28	24
1½" PEX x 1" PEX x 1" PEX	Q4751511	11/16	13/16	13/16	13/16	17/16	13/16
		43	30	30	30	28	30
1½" PEX x 1" PEX x 1½" PEX	Q4751505	11/16	1¼	1¼	13/16	15/16	11/16
		43	32	32	30	24	43



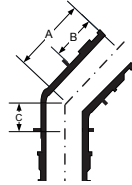
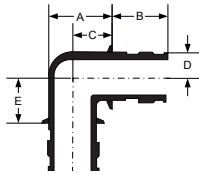
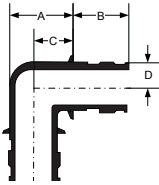
ProPEX EP reducing tees		A	B	C	D	E	F
Description	Part no.	in	in	in	in	in	in
		mm	mm	mm	mm	mm	mm
1½" PEX x 1¼" PEX x ¾" PEX	Q4751537	1⅞	1⅞	1⅞	1⅞	⅞	1⅞
		43	29	29	37	23	24
1½" PEX x 1¼" PEX x 1" PEX	Q4751531	1⅞	1⅞	1⅞	1⅞	⅞	1⅞
		43	29	29	37	23	30
1½" PEX x 1¼" PEX x ¼" PEX	Q4751533	1⅞	1⅞	1⅞	1⅞	⅞	1⅞
		43	29	29	37	23	37
1½" PEX x 1½" PEX x ½" PEX	Q4751550	1⅞	¾	¾	1⅞	1⅞	¾
		43	19	19	43	21	19
1½" PEX x 1½" PEX x ¾" PEX	Q4751557	1⅞	1⅞	1⅞	1⅞	1⅞	1⅞
		43	30	30	43	28	24
1½" PEX x 1½" PEX x 1" PEX	Q4751551	1⅞	1⅞	1⅞	1⅞	1⅞	1⅞
		43	30	30	43	28	30
1½" PEX x 1½" PEX x ¼" PEX	Q4751553	1⅞	1⅞	1⅞	1⅞	1⅞	1⅞
		43	30	30	43	28	37
2" PEX x 1½" PEX x ¾" PEX	Q4752575	2⅞	1⅞	1⅞	1⅞	1⅞	1⅞
		56	34	34	43	33	24
2" PEX x 1½" PEX x 1" PEX	Q4752051	2⅞	1⅞	1⅞	1⅞	1⅞	1⅞
		56	34	34	43	33	30
2" PEX x 1½" PEX x ¼" PEX	Q4752053	2⅞	1⅞	1⅞	1⅞	1⅞	1⅞
		56	35	35	43	33	37
2" PEX x 1½" PEX x ½" PEX	Q4752055	2⅞	1⅞	1⅞	1⅞	1⅞	1⅞
		56	35	35	43	33	43
2" PEX x 1½" PEX x 2" PEX	Q4752152	2⅞	1¼	1¼	1⅞	1⅞	2⅞
		56	44	44	43	26	56
2" PEX x 2" PEX x ½" PEX	Q4752250	2⅞	¾	¾	2⅞	1⅞	¾
		56	19	19	56	26	19
2" PEX x 2" PEX x ¾" PEX	Q4752275	2⅞	1⅞	1⅞	2⅞	1⅞	1⅞
		56	34	34	56	33	24
2" PEX x 2" PEX x 1" PEX	Q4752210	2⅞	1⅞	1⅞	2⅞	1⅞	1⅞
		56	34	34	56	33	30
2" PEX x 2" PEX x ¼" PEX	Q4752213	2⅞	1⅞	1⅞	2⅞	1⅞	1⅞
		56	34	34	56	33	37
2" PEX x 2" PEX x ½" PEX	Q4752215	2⅞	1⅞	1⅞	2⅞	1⅞	1⅞
		56	34	34	56	33	43



ProPEX EP reducing tees		A	B	C	D	E	F
Description	Part no.	in	in	in	in	in	in
		mm	mm	mm	mm	mm	mm
2½" PEX x 2" PEX x 1½" PEX	Q4752525	2 <sup>13</sup> / <sub>16</sub>	1 <sup>5</sup> / <sub>8</sub>	1 <sup>5</sup> / <sub>8</sub>	2 <sup>3</sup> / <sub>16</sub>	1 <sup>5</sup> / <sub>16</sub>	1 <sup>11</sup> / <sub>16</sub>
		72	41	41	56	33	43
2½" PEX x 2" PEX x 2" PEX	Q4752522	2 <sup>13</sup> / <sub>16</sub>	2	2	2 <sup>3</sup> / <sub>16</sub>	1 <sup>5</sup> / <sub>16</sub>	2 <sup>3</sup> / <sub>16</sub>
		72	51	51	56	33	56
2½" PEX x 2½" PEX x ¾" PEX	Q4752557	2 <sup>13</sup> / <sub>16</sub>	1 <sup>1</sup> / <sub>8</sub>	1 <sup>1</sup> / <sub>8</sub>	2 <sup>13</sup> / <sub>16</sub>	1 <sup>5</sup> / <sub>16</sub>	1 <sup>8</sup> / <sub>16</sub>
		72	29	29	72	33	24
2½" PEX x 2½" PEX x 1" PEX	Q4752510	2 <sup>13</sup> / <sub>16</sub>	1¼	1¼	2 <sup>13</sup> / <sub>16</sub>	1 <sup>5</sup> / <sub>16</sub>	1 <sup>3</sup> / <sub>16</sub>
		72	32	32	72	33	30
2½" PEX x 2½" PEX x 1¼" PEX	Q4752513	2 <sup>13</sup> / <sub>16</sub>	1½	1½	2 <sup>13</sup> / <sub>16</sub>	1 <sup>5</sup> / <sub>16</sub>	1 <sup>7</sup> / <sub>16</sub>
		72	38	38	72	33	37
2½" PEX x 2½" PEX x 1½" PEX	Q4752515	2 <sup>13</sup> / <sub>16</sub>	1 <sup>5</sup> / <sub>8</sub>	1 <sup>5</sup> / <sub>8</sub>	2 <sup>13</sup> / <sub>16</sub>	1 <sup>5</sup> / <sub>16</sub>	1 <sup>11</sup> / <sub>16</sub>
		72	41	41	72	33	43
2½" PEX x 2½" PEX x 2" PEX	Q4752520	2 <sup>13</sup> / <sub>16</sub>	2	2	2 <sup>13</sup> / <sub>16</sub>	1¼	2 <sup>3</sup> / <sub>16</sub>
		72	51	51	72	32	56
3" PEX x 2" PEX x 2" PEX	Q4753220	3 <sup>3</sup> / <sub>8</sub>	2	2	2 <sup>3</sup> / <sub>16</sub>	1 <sup>9</sup> / <sub>16</sub>	2 <sup>3</sup> / <sub>16</sub>
		86	51	51	56	39	56
3" PEX x 2½" PEX x 1½" PEX	Q4753215	3 <sup>3</sup> / <sub>8</sub>	1 <sup>5</sup> / <sub>8</sub>	1 <sup>5</sup> / <sub>8</sub>	2 <sup>13</sup> / <sub>16</sub>	1 <sup>9</sup> / <sub>16</sub>	1 <sup>11</sup> / <sub>16</sub>
		86	41	41	72	39	43
3" PEX x 2½" PEX x 2" PEX	Q4753252	3 <sup>3</sup> / <sub>8</sub>	2	2	2 <sup>13</sup> / <sub>16</sub>	1 <sup>9</sup> / <sub>16</sub>	2 <sup>3</sup> / <sub>16</sub>
		86	51	51	72	39	56
3" PEX x 3" PEX x ¾" PEX	Q4753375	3 <sup>3</sup> / <sub>8</sub>	1 <sup>1</sup> / <sub>8</sub>	1 <sup>1</sup> / <sub>8</sub>	3 <sup>3</sup> / <sub>8</sub>	1 <sup>9</sup> / <sub>16</sub>	1 <sup>5</sup> / <sub>16</sub>
		86	29	29	86	39	24
3" PEX x 3" PEX x 1" PEX	Q4753310	3 <sup>3</sup> / <sub>8</sub>	1¼	1¼	3 <sup>3</sup> / <sub>8</sub>	1 <sup>9</sup> / <sub>16</sub>	1 <sup>3</sup> / <sub>16</sub>
		86	32	32	86	39	30
3" PEX x 3" PEX x 1¼" PEX	Q4753313	3 <sup>3</sup> / <sub>8</sub>	1½	1½	3 <sup>3</sup> / <sub>8</sub>	1 <sup>9</sup> / <sub>16</sub>	1 <sup>7</sup> / <sub>16</sub>
		86	38	38	86	39	37
3" PEX x 3" PEX x 1½" PEX	Q4753315	3 <sup>3</sup> / <sub>8</sub>	1 <sup>5</sup> / <sub>8</sub>	1 <sup>5</sup> / <sub>8</sub>	3 <sup>3</sup> / <sub>8</sub>	1 <sup>9</sup> / <sub>16</sub>	1 <sup>11</sup> / <sub>16</sub>
		86	41	41	86	39	43
3" PEX x 3" PEX x 2" PEX	Q4753320	3 <sup>3</sup> / <sub>8</sub>	2	2	3 <sup>3</sup> / <sub>8</sub>	1 <sup>9</sup> / <sub>16</sub>	2 <sup>13</sup> / <sub>16</sub>
		86	51	51	86	39	72
3" PEX x 3" PEX x 2½" PEX	Q4753325	3 <sup>3</sup> / <sub>8</sub>	2½	2½	3 <sup>3</sup> / <sub>8</sub>	1 <sup>9</sup> / <sub>16</sub>	2 <sup>13</sup> / <sub>16</sub>
		86	64	64	86	39	72



ProPEX tees		A	B	C
Description	Part no.	in	in	in
		mm	mm	mm
½" PEX x ½" PEX x ½" PEX	Q4755050	¾	9/16	3/8
		19	15	10
½" PEX x ½" PEX x ½" PEX	LF4705050	11/16	9/16	5/16
		18	14	8
¾" PEX x ¾" PEX x ¾" PEX	Q4757575	15/16	11/16	½
		24	18	13
¾" PEX x ¾" PEX x ¾" PEX	LF4707575	15/16	11/16	3/8
		24	18	10
1" PEX x 1" PEX x 1" PEX	Q4751010	13/16	7/8	11/16
		30	22	18
1" PEX x 1" PEX x 1" PEX	LF4701010	13/16	7/8	9/16
		30	22	14
1¼" PEX x 1¼" PEX x 1¼" PEX	Q4751313	17/16	15/16	15/16
		37	25	24
1½" PEX x 1½" PEX x 1½" PEX	Q4751515	11/16	13/16	1/8
		43	30	28
2" PEX x 2" PEX x 2" PEX	Q4752000	23/16	19/16	15/8
		56	40	41
2½" PEX x 2½" PEX x 2½" PEX	Q4752500	213/16	27/16	15/16
		72	62	34
3" PEX x 3" PEX x 3" PEX	Q4753000	33/8	2¾	17/16
		86	70	37



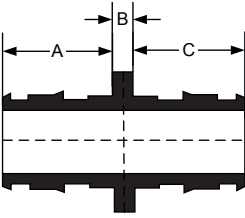
EP elbow

Brass elbow

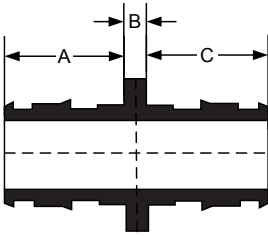
EP 45 elbow

ProPEX elbows		A	B	C	D	E
Description	Part no.	in	in	in	in	in
		mm	mm	mm	mm	mm
½" PEX x ½" PEX EP Elbow	Q4760500	1 <sup>1</sup> / <sub>16</sub> 21	¾ 19	9 <sup>9</sup> / <sub>16</sub> 14	¼ 7	
¾" PEX x ¾" PEX EP Elbow	Q4760750	1 <sup>1</sup> / <sub>16</sub> 27	18 <sup>18</sup> / <sub>16</sub> 24	11 <sup>11</sup> / <sub>16</sub> 17	3 <sup>3</sup> / <sub>8</sub> 10	
¾" PEX x ¾" PEX LF Brass Elbow	LF4710750	1 <sup>1</sup> / <sub>16</sub> 27	18 <sup>18</sup> / <sub>16</sub> 24	11 <sup>11</sup> / <sub>16</sub> 18	3 <sup>3</sup> / <sub>8</sub> 10	3 <sup>3</sup> / <sub>8</sub> 10
1" PEX x 1" PEX EP Elbow	Q4761000	1 <sup>5</sup> / <sub>8</sub> 42	1 <sup>3</sup> / <sub>16</sub> 30	7 <sup>7</sup> / <sub>8</sub> 22	1 <sup>13</sup> / <sub>16</sub> 20	
1" PEX x 1" PEX EP 45 Elbow	Q4761010	1 <sup>3</sup> / <sub>4</sub> 46	1 <sup>3</sup> / <sub>16</sub> 30	9 <sup>9</sup> / <sub>16</sub> 14		
1" PEX x 1" PEX LF Brass Elbow	LF4711000	1 <sup>1</sup> / <sub>4</sub> 32	1 <sup>3</sup> / <sub>16</sub> 30	7 <sup>7</sup> / <sub>8</sub> 22	1 <sup>13</sup> / <sub>16</sub> 14	9 <sup>9</sup> / <sub>16</sub> 14
1¼" PEX x 1¼" PEX EP Elbow	Q4761250	1 <sup>3</sup> / <sub>4</sub> 43	1 <sup>7</sup> / <sub>16</sub> 37	1 <sup>1</sup> / <sub>8</sub> 28	5 <sup>5</sup> / <sub>8</sub> 15	
1¼" PEX x 1¼" PEX EP 45 Elbow	Q4761313	2 <sup>1</sup> / <sub>16</sub> 52	1 <sup>7</sup> / <sub>16</sub> 37	5 <sup>5</sup> / <sub>8</sub> 15		
1½" PEX x 1½" PEX EP Elbow	Q4761500	1 <sup>7</sup> / <sub>8</sub> 47	1 <sup>11</sup> / <sub>16</sub> 43	1 <sup>3</sup> / <sub>16</sub> 30	1 <sup>11</sup> / <sub>16</sub> 17	
1½" PEX x 1½" PEX EP 45 Elbow	Q4761515	2 <sup>5</sup> / <sub>16</sub> 59	1 <sup>11</sup> / <sub>16</sub> 43	5 <sup>5</sup> / <sub>8</sub> 15		
2" PEX x 2" PEX EP Elbow	Q4762000	2 <sup>9</sup> / <sub>16</sub> 65	2 <sup>3</sup> / <sub>16</sub> 56	1 <sup>5</sup> / <sub>8</sub> 41	1 <sup>15</sup> / <sub>16</sub> 24	
2" PEX x 2" PEX EP 45 Elbow	Q4762020	2 <sup>18</sup> / <sub>16</sub> 74	2 <sup>3</sup> / <sub>16</sub> 56	¾ 19		
2½" PEX x 2½" PEX EP Elbow	Q4762500	3 <sup>5</sup> / <sub>16</sub> 84	2 <sup>13</sup> / <sub>16</sub> 72	2 <sup>1</sup> / <sub>8</sub> 53	1 <sup>13</sup> / <sub>16</sub> 31	
2½" PEX x 2½" PEX EP 45 Elbow	Q4762525	3 <sup>13</sup> / <sub>16</sub> 97	2 <sup>13</sup> / <sub>16</sub> 72	1 25		
3" PEX x 3" PEX EP Elbow	Q4763000	3 <sup>15</sup> / <sub>16</sub> 99	3 <sup>3</sup> / <sub>8</sub> 86	2½ 64	1 <sup>7</sup> / <sub>16</sub> 36	
3" PEX x 3" PEX EP 45 Elbow	Q4763030	4½ 114	3 <sup>3</sup> / <sub>8</sub> 86	1 <sup>1</sup> / <sub>8</sub> 28		

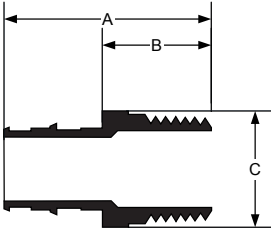




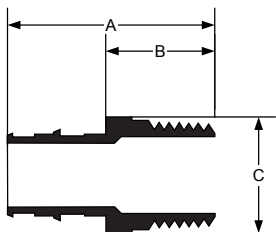
ProPEX couplings		A	B	C
Description	Part no.	in	in	in
		mm	mm	mm
½" PEX x ½" PEX	Q4775050	¾ 19	⅛ 3	¾ 19
	LF4545050	⅞ 18	⅛ 3	⅞ 18
¾" PEX x ¾" PEX	Q4777575	⅞ 24	⅛ 3	⅞ 24
	LF4547575	⅞ 24	⅛ 3	⅞ 24
1" PEX x 1" PEX	Q4771010	⅞ 30	⅛ 3	⅞ 30
	LF4541010	⅞ 30	⅛ 3	⅞ 30
1¼" PEX x 1¼" PEX	Q4771313	1⅞ 37	⅛ 3	1⅞ 37
	Q4771515	1⅞ 44	⅛ 3	1⅞ 44
2" PEX x 2" PEX	Q4772020	2⅞ 56	¼ 6	2⅞ 56
	Q4772525	2⅞ 72	¼ 6	2⅞ 72
3" PEX x 3" PEX	Q4773030	3⅞ 86	¼ 6	3⅞ 86



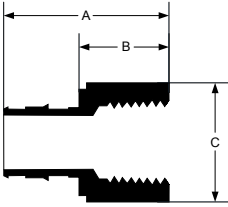
ProPEX reducing couplings		A	B	C
Description	Part no.	in	in	in
		mm	mm	mm
¾" PEX x ½" PEX	Q4775075	1 <sup>5</sup> / <sub>16</sub>	1/8	¾
		24	3	19
1" PEX x ¾" PEX	Q4777510	1 <sup>8</sup> / <sub>16</sub>	1/8	1 <sup>5</sup> / <sub>16</sub>
	LF4547510	30	3	24
1¼" PEX x ¾" PEX	Q4771307	1 <sup>8</sup> / <sub>16</sub>	1/8	1 <sup>5</sup> / <sub>16</sub>
		30	3	24
1¼" PEX x 1" PEX	Q4771310	1 <sup>7</sup> / <sub>16</sub>	1/8	1 <sup>8</sup> / <sub>16</sub>
		37	3	30
1½" PEX x ¾" PEX	Q4771507	1 <sup>11</sup> / <sub>16</sub>	1/8	1 <sup>5</sup> / <sub>16</sub>
		44	3	24
1½" PEX x 1" PEX	Q4771510	1 <sup>11</sup> / <sub>16</sub>	1/8	1 <sup>8</sup> / <sub>16</sub>
		44	3	30
1½" PEX x 1¼" PEX	Q4771513	1 <sup>11</sup> / <sub>16</sub>	1/8	1 <sup>7</sup> / <sub>16</sub>
		44	3	37
2" PEX x 1½" PEX	Q4772015	2 <sup>3</sup> / <sub>16</sub>	¼	1 <sup>11</sup> / <sub>16</sub>
		56	6	44
2½" PEX x 1¼" PEX	Q4772513	2 <sup>13</sup> / <sub>16</sub>	¼	1 <sup>7</sup> / <sub>16</sub>
		72	6	37
2½" PEX x 1½" PEX	Q4772515	2 <sup>13</sup> / <sub>16</sub>	¼	1 <sup>11</sup> / <sub>16</sub>
		72	6	44
2½" PEX x 2" PEX	Q4772520	2 <sup>13</sup> / <sub>16</sub>	¼	2 <sup>3</sup> / <sub>16</sub>
		72	6	56
3" PEX x 2" PEX	Q4773020	3 <sup>3</sup> / <sub>8</sub>	¼	2 <sup>3</sup> / <sub>16</sub>
		86	6	56
3" PEX x 2½" PEX	Q4773025	3 <sup>3</sup> / <sub>8</sub>	¼	2 <sup>13</sup> / <sub>16</sub>
		86	6	72



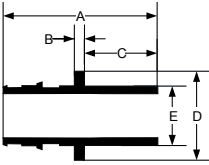
ProPEX brass male threaded adapters		A	B	C
Description	Part no.	in	in	in
		mm	mm	mm
3/8" PEX x 1/2" NPT	LF4523850	1 5/8	1	7/8
		41	25	22
1/2" PEX x 1/2" NPT	Q5525050	1 5/8	7/8	7/8
		41	23	22
	LF4525050	1 11/16	1 5/16	7/8
		42	24	22
1/2" PEX x 3/4" NPT	LF4525075	1 3/16	1 1/16	1 1/8
		45	27	29
3/4" PEX x 3/4" NPT	LF4527575	1 7/8	1	1 1/8
		48	25	29
	Q5527575	1 7/8	7/8	1 1/8
		47	23	29
3/4" PEX x 1" NPT	LF4527510	2 1/4	1 1/4	1 3/8
		56	32	35
	Q5527510	2	1 1/16	1 3/8
		51	27	35
1" PEX x 3/4" NPT	LF4521075	2 1/4	1 1/16	1 1/4
		57	27	32
	Q5521075	2 1/16	1 1/16	1 1/4
		53	27	32
1" PEX x 1" NPT	LF4521010	2 5/16	1 1/8	1 3/8
		59	29	35
	Q5521010	2 1/4	1 1/16	1 3/8
		57	27	35
1 1/4" PEX x 1 1/4" NPT	LF4521313	2 5/8	1 3/16	1 3/4
		66	30	44
	Q5521313	2 1/2	1 1/16	1 3/4
		64	27	44



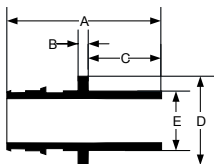
ProPEX brass male threaded adapters		A	B	C
Description	Part no.	in	in	in
		mm	mm	mm
1½" PEX x 1½" NPT	LF4521515	3	1¼	2
		76	32	51
	Q5521515	2 <sup>18</sup> / <sub>16</sub>	1¼	2
		74	32	51
2" PEX x 2" NPT	LF4522020	3 <sup>9</sup> / <sub>16</sub>	1 <sup>3</sup> / <sub>8</sub>	2 <sup>3</sup> / <sub>8</sub>
		90	35	60
	Q5522020	3 <sup>7</sup> / <sub>16</sub>	1 <sup>5</sup> / <sub>16</sub>	2 <sup>3</sup> / <sub>8</sub>
		87	33	60
2½" PEX x 2½" NPT	LF4522525	4 <sup>19</sup> / <sub>16</sub>	2	3¼
		123	51	83
3" PEX x 3" NPT	LF4523030	5½	2 <sup>1</sup> / <sub>8</sub>	3¼
		140	55	95



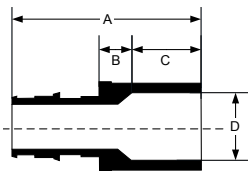
ProPEX brass female threaded adapters		A	B	C
Description	Part no.	in	in	in
		mm	mm	mm
½" PEX x ½" NPT	Q5575050	1 <sup>9</sup> / <sub>16</sub> 40	7/ <sub>8</sub> 22	1 25
	LF4575050	1 <sup>9</sup> / <sub>16</sub> 40	7/ <sub>8</sub> 22	1 25
½" PEX x ¾" NPT	LF4575075	1¾ 44	1 <sup>1</sup> / <sub>16</sub> 26	1 <sup>3</sup> / <sub>16</sub> 30
		¾" PEX x ¾" NPT	Q5577575	1 <sup>7</sup> / <sub>8</sub> 47
¾" PEX x 1" NPT	LF4577575		1 <sup>7</sup> / <sub>8</sub> 47	7/ <sub>8</sub> 23
	¾" PEX x 1" NPT	Q5577510	2 <sup>1</sup> / <sub>8</sub> 54	1 <sup>3</sup> / <sub>16</sub> 32
LF4577510		2 <sup>3</sup> / <sub>16</sub> 56	1¼ 32	1½ 38
1" PEX x 1" NPT	Q5571010	2 <sup>3</sup> / <sub>8</sub> 60	1 <sup>3</sup> / <sub>16</sub> 30	1½ 38
	LF4571010	2 <sup>3</sup> / <sub>8</sub> 60	1 <sup>3</sup> / <sub>16</sub> 30	1½ 38
1¼" PEX x 1¼" NPT	Q5571313	2 <sup>9</sup> / <sub>16</sub> 65	1 <sup>1</sup> / <sub>8</sub> 28	2 51
	LF4571313	2 <sup>9</sup> / <sub>16</sub> 65	1 <sup>1</sup> / <sub>8</sub> 28	2 51
1½" PEX x 1½" NPT	Q5571515	2 <sup>7</sup> / <sub>8</sub> 73	1 <sup>1</sup> / <sub>8</sub> 29	2¼ 57
	LF4571515	2 <sup>7</sup> / <sub>8</sub> 73	1 <sup>1</sup> / <sub>8</sub> 29	2¼ 57
2" PEX x 2" NPT	Q5572020	3 <sup>9</sup> / <sub>16</sub> 90	1 <sup>3</sup> / <sub>8</sub> 35	3 76
	LF4572020	3 <sup>9</sup> / <sub>16</sub> 90	1 <sup>3</sup> / <sub>8</sub> 35	3 76



ProPEX brass fitting adapters		A	B	C	D	E
Description	Part no.	in	in	in	in	in
		mm	mm	mm	mm	mm
½" PEX x ½" Copper	LF4505050	1 <sup>3</sup> / <sub>8</sub> 35	1/8 3	9/16 14	3/4 19	5/8 16
	Q5505050	1 <sup>11</sup> / <sub>16</sub> 43	1/8 3	7/8 22	3/4 19	5/8 16
½" PEX x ¾" Copper	LF4505075	1 <sup>5</sup> / <sub>8</sub> 42	1/8 3	1 <sup>3</sup> / <sub>16</sub> 21	1 <sup>5</sup> / <sub>16</sub> 23	7/8 22
	Q4506350	1 <sup>9</sup> / <sub>16</sub> 39	1/8 3	9/16 14	1 <sup>1</sup> / <sub>16</sub> 26	5/8 16
5/8" PEX x ½" Copper	Q4506375	1 <sup>13</sup> / <sub>16</sub> 46	1/8 3	1 <sup>3</sup> / <sub>16</sub> 21	1 <sup>5</sup> / <sub>16</sub> 24	7/8 22
	LF4507550	1 <sup>5</sup> / <sub>8</sub> 41	1/8 3	9/16 14	1 <sup>1</sup> / <sub>8</sub> 28	5/8 16
¾" PEX x ½" Copper	Q5507550	1 <sup>15</sup> / <sub>16</sub> 50	1/8 3	7/8 22	1 <sup>1</sup> / <sub>8</sub> 28	5/8 16
	LF4507575	1 <sup>1</sup> / <sub>8</sub> 48	1/8 3	1 <sup>3</sup> / <sub>16</sub> 21	1 <sup>1</sup> / <sub>8</sub> 28	7/8 22
¾" PEX x ¾" Copper	Q5507575	2 <sup>1</sup> / <sub>16</sub> 53	1/8 3	1 25	1 <sup>1</sup> / <sub>8</sub> 28	7/8 22
	LF4507510	2 <sup>1</sup> / <sub>16</sub> 53	1/8 3	1 25	1 <sup>3</sup> / <sub>16</sub> 30	1 <sup>1</sup> / <sub>8</sub> 28
¾" PEX x 1" Copper	Q5507510	2 <sup>1</sup> / <sub>16</sub> 53	1/8 3	1 25	1 <sup>1</sup> / <sub>8</sub> 29	1 <sup>1</sup> / <sub>8</sub> 28
	LF4501010	2 <sup>1</sup> / <sub>4</sub> 58	1/8 3	1 25	1 <sup>3</sup> / <sub>8</sub> 35	1 <sup>1</sup> / <sub>8</sub> 29
1" PEX x 1" Copper	Q5501010	2 <sup>5</sup> / <sub>16</sub> 59	1/8 3	1 25	1 <sup>3</sup> / <sub>8</sub> 35	1 <sup>1</sup> / <sub>8</sub> 29
	LF4501313	2 <sup>9</sup> / <sub>8</sub> 66	1/8 3	1 25	1 <sup>5</sup> / <sub>8</sub> 42	1 <sup>3</sup> / <sub>8</sub> 35
1¼" PEX x 1¼" Copper	Q5501313	2 <sup>11</sup> / <sub>16</sub> 69	1/8 3	1 <sup>1</sup> / <sub>8</sub> 29	1 <sup>3</sup> / <sub>4</sub> 44	1 <sup>3</sup> / <sub>8</sub> 35

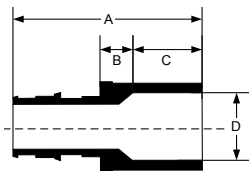


ProPEX brass fitting adapters		A	B	C	D	E
Description	Part no.	in	in	in	in	in
		mm	mm	mm	mm	mm
1½" PEX x 1½" Copper	LF4501515	3	1/8	1 <sup>9</sup> / <sub>16</sub>	1 <sup>7</sup> / <sub>8</sub>	1 <sup>5</sup> / <sub>8</sub>
		76	3	29	48	41
	Q5501515	3 <sup>3</sup> / <sub>8</sub>	1/8	1 <sup>9</sup> / <sub>16</sub>	1 <sup>7</sup> / <sub>8</sub>	1 <sup>5</sup> / <sub>8</sub>
		86	3	40	48	41
2" PEX x 2" Copper	LF4502020	3 <sup>18</sup> / <sub>16</sub>	¼	1 <sup>7</sup> / <sub>16</sub>	2 <sup>5</sup> / <sub>8</sub>	2 <sup>1</sup> / <sub>8</sub>
		97	6	36	66	54
	Q5502020	4 <sup>1</sup> / <sub>8</sub>	¼	1 <sup>3</sup> / <sub>4</sub>	2 <sup>11</sup> / <sub>16</sub>	2 <sup>1</sup> / <sub>8</sub>
		105	6	44	68	54

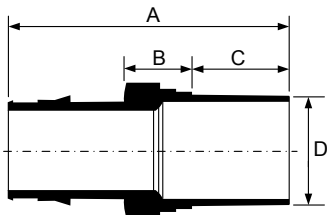


ProPEX brass sweat adapters		A	B	C	D
Description	Part no.	in	in	in	in
		mm	mm	mm	mm
3/8" PEX x 1/2" Copper	LF4513850	1 <sup>5</sup> / <sub>16</sub> 34	1/4 6	1/2 13	5/8 16
	LF4515050	1 <sup>3</sup> / <sub>8</sub> 35	3/10 5	1/2 13	5/8 16
1/2" PEX x 1/2" Copper	Q5515050	1 <sup>3</sup> / <sub>8</sub> 35	3/10 5	1/2 13	5/8 16
	LF4515075	1 <sup>5</sup> / <sub>8</sub> 41	3/10 5	3/4 19	7/8 22
3/4" PEX x 1/2" Copper	LF4517550	1 <sup>1</sup> / <sub>16</sub> 42	1/4 6	1/2 13	5/8 16
	Q5517550	1 <sup>1</sup> / <sub>16</sub> 42	1/4 6	1/2 13	5/8 16
3/4" PEX x 3/4" Copper	LF4517575	1 <sup>7</sup> / <sub>8</sub> 47	3/10 5	3/4 19	7/8 22
	Q5517575	1 <sup>7</sup> / <sub>8</sub> 47	3/10 5	3/4 19	7/8 22
3/4" PEX x 1" Copper	LF4517510	2 <sup>1</sup> / <sub>8</sub> 53	1/4 6	1 <sup>5</sup> / <sub>16</sub> 23	1 <sup>1</sup> / <sub>8</sub> 29
	Q5517510	2 <sup>1</sup> / <sub>8</sub> 53	1/4 6	1 <sup>5</sup> / <sub>16</sub> 23	1 <sup>1</sup> / <sub>8</sub> 29
1" PEX x 1" Copper	LF4511010	2 <sup>1</sup> / <sub>4</sub> 58	3/10 5	1 <sup>5</sup> / <sub>16</sub> 23	1 <sup>1</sup> / <sub>8</sub> 29
	Q5511010	2 <sup>1</sup> / <sub>4</sub> 58	3/10 5	1 <sup>5</sup> / <sub>16</sub> 23	1 <sup>1</sup> / <sub>8</sub> 29
1 1/4" PEX x 1 1/4" Copper	LF4511313	2 <sup>5</sup> / <sub>8</sub> 66	3/10 5	1 25	1 <sup>3</sup> / <sub>8</sub> 35
	Q5511313	2 <sup>5</sup> / <sub>8</sub> 66	3/10 5	1 25	1 <sup>3</sup> / <sub>8</sub> 35

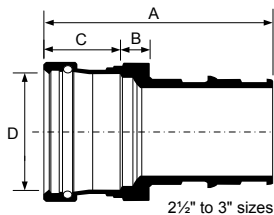
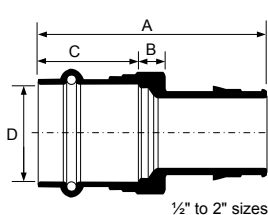




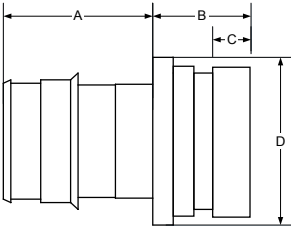
ProPEX brass sweat adapters		A	B	C	D
Description	Part no.	in	in	in	in
		mm	mm	mm	mm
1½" PEX x 1½" Copper	LF4511515	3 <sup>9</sup> / <sub>16</sub>	¼	1 <sup>1</sup> / <sub>16</sub>	1 <sup>5</sup> / <sub>8</sub>
		78	6	28	41
	Q5511515	3 <sup>9</sup> / <sub>16</sub>	¼	1 <sup>1</sup> / <sub>16</sub>	1 <sup>5</sup> / <sub>8</sub>
		78	6	28	41
2" PEX x 2" Copper	LF4512020	3¾	¼	1 <sup>5</sup> / <sub>16</sub>	2 <sup>1</sup> / <sub>8</sub>
		95	6	34	54
	Q5512020	3¾	¼	1 <sup>5</sup> / <sub>16</sub>	2 <sup>1</sup> / <sub>8</sub>
		95	6	34	54
2½" PEX x 2½" Copper	LF4512525	4 <sup>9</sup> / <sub>16</sub>	5 <sup>1</sup> / <sub>16</sub>	1 <sup>7</sup> / <sub>16</sub>	2 <sup>5</sup> / <sub>8</sub>
		116	8	37	67
3" PEX x 3" Copper	LF4513030	5 <sup>5</sup> / <sub>16</sub>	5 <sup>1</sup> / <sub>16</sub>	1 <sup>11</sup> / <sub>16</sub>	3 <sup>1</sup> / <sub>8</sub>
		135	8	42	80



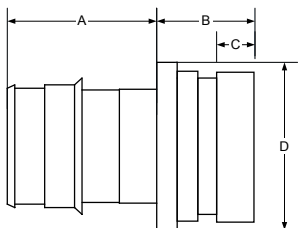
ProPEX LF brass copper press fitting adapters		A	B	C	D
Description	Part no.	in	in	in	in
		mm	mm	mm	mm
½" PEX x ½" copper	LFP4505050	2	9/16	¾	5/8
		51	14	19	16
¾" PEX x ¾" copper	LFP4507575	2 3/8	5/8	7/8	7/8
		61	15	22	22
1" PEX x 1" copper	LFP4501010	2 7/8	1 1/16	1	1 1/8
		73	17	25	29
1 ¼" PEX x 1 ¼" copper	LFP4501313	3 5/16	¾	1 1/16	1 3/8
		84	19	27	35
1 ½" PEX x 1 ½" copper	LFP4501515	3 7/8	¾	1 7/16	1 5/8
		99	19	36	41
2" PEX x 2" copper	LFP4502020	4 5/8	1 5/16	1 9/16	2 1/8
		118	24	40	54
2 ½" PEX x 2 ½" copper	LFP4502525	5 7/8	1 3/8	1 5/8	2 5/8
		149	36	41	67
3" PEX x 3" copper	LFP4503030	6 11/16	1 ½	1 13/16	3 1/8
		169	38	46	79



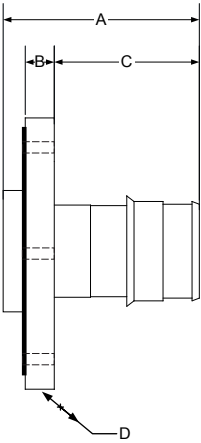
<b>ProPEX LF brass copper press adapters</b>		<b>A</b>	<b>B</b>	<b>C</b>	<b>D</b>
<b>Description</b>	<b>Part no.</b>	<b>in</b>	<b>in</b>	<b>in</b>	<b>in</b>
		<b>mm</b>	<b>mm</b>	<b>mm</b>	<b>mm</b>
½" PEX x ½" copper	LFP4515050	2 <sup>1</sup> / <sub>16</sub>	7 <sup>1</sup> / <sub>16</sub>	7 <sup>1</sup> / <sub>8</sub>	5 <sup>1</sup> / <sub>8</sub>
		53	11	22	16
¾" PEX x ¾" copper	LFP4517575	2 <sup>9</sup> / <sub>16</sub>	9 <sup>1</sup> / <sub>16</sub>	7 <sup>1</sup> / <sub>8</sub>	7 <sup>1</sup> / <sub>8</sub>
		61	14	22	22
1" PEX x 1" copper	LFP4511010	2 <sup>11</sup> / <sub>16</sub>	5 <sup>1</sup> / <sub>16</sub>	1 <sup>3</sup> / <sub>16</sub>	1 <sup>1</sup> / <sub>8</sub>
		68	8	30	29
1¼" PEX x 1¼" copper	LFP4511313	3 <sup>1</sup> / <sub>16</sub>	9 <sup>1</sup> / <sub>16</sub>	1	1 <sup>3</sup> / <sub>8</sub>
		77	14	25	35
1½" PEX x 1½" copper	LFP4511515	3 <sup>5</sup> / <sub>8</sub>	9 <sup>1</sup> / <sub>16</sub>	1 <sup>5</sup> / <sub>16</sub>	1 <sup>5</sup> / <sub>8</sub>
		91	14	34	42
2" PEX x 2" copper	LFP4512020	4 <sup>5</sup> / <sub>8</sub>	½	2	2 <sup>1</sup> / <sub>8</sub>
		118	12	51	54
2½" PEX x 2½" copper	LFP4512525	5¼	1 <sup>1</sup> / <sub>16</sub>	1¾	2 <sup>5</sup> / <sub>8</sub>
		133	17	44	67
3" PEX x 3" copper	LFP4513030	6 <sup>1</sup> / <sub>8</sub>	1 <sup>5</sup> / <sub>16</sub>	1 <sup>15</sup> / <sub>16</sub>	3 <sup>1</sup> / <sub>8</sub>
		156	24	49	80



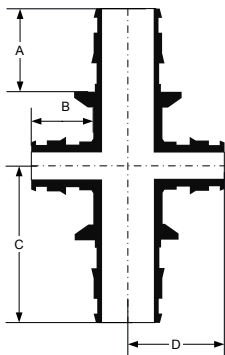
ProPEX LF brass groove fitting adapters		A	B	C	D
Description	Part no.	in	in	in	in
		mm	mm	mm	mm
2" PEX x 2" CTS Groove	LFV2962020	2 <sup>1</sup> / <sub>8</sub>	1 <sup>1</sup> / <sub>2</sub>	5 <sup>5</sup> / <sub>8</sub>	2 <sup>11</sup> / <sub>16</sub>
		54	38	15	68
2" PEX x 2 <sup>1</sup> / <sub>2</sub> " CTS Groove	LFV2962025	2 <sup>1</sup> / <sub>8</sub>	1 <sup>1</sup> / <sub>2</sub>	5 <sup>5</sup> / <sub>8</sub>	2 <sup>11</sup> / <sub>16</sub>
		54	38	15	68
2 <sup>1</sup> / <sub>2</sub> " PEX x 2 <sup>1</sup> / <sub>2</sub> " CTS Groove	LFV2962525	2 <sup>3</sup> / <sub>16</sub>	1 <sup>1</sup> / <sub>2</sub>	5 <sup>5</sup> / <sub>8</sub>	3 <sup>3</sup> / <sub>8</sub>
		72	38	15	86
3" PEX x 3" CTS Groove	LFV2963030	3 <sup>3</sup> / <sub>8</sub>	1 <sup>1</sup> / <sub>2</sub>	5 <sup>5</sup> / <sub>8</sub>	3 <sup>13</sup> / <sub>16</sub>
		86	38	15	96
2" PEX x 2" IPS Groove	LFV2972020	2 <sup>1</sup> / <sub>8</sub>	1 <sup>1</sup> / <sub>2</sub>	5 <sup>5</sup> / <sub>8</sub>	2 <sup>11</sup> / <sub>16</sub>
		54	38	15	68
2" PEX x 2 <sup>1</sup> / <sub>2</sub> " IPS Groove	LFV2972025	2 <sup>1</sup> / <sub>8</sub>	1 <sup>1</sup> / <sub>2</sub>	5 <sup>5</sup> / <sub>8</sub>	2 <sup>7</sup> / <sub>8</sub>
		54	38	15	73
2 <sup>1</sup> / <sub>2</sub> " PEX x 2" IPS Groove	LFV2972520	2 <sup>3</sup> / <sub>16</sub>	1 <sup>1</sup> / <sub>2</sub>	5 <sup>5</sup> / <sub>8</sub>	3 <sup>3</sup> / <sub>8</sub>
		72	38	15	86
2 <sup>1</sup> / <sub>2</sub> " PEX x 2 <sup>1</sup> / <sub>2</sub> " IPS Groove	LFV2972525	2 <sup>3</sup> / <sub>16</sub>	1 <sup>1</sup> / <sub>2</sub>	5 <sup>5</sup> / <sub>8</sub>	3 <sup>3</sup> / <sub>8</sub>
		72	38	15	86



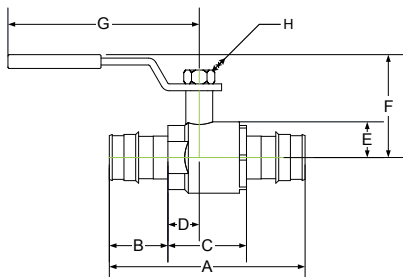
ProPEX LF brass groove fitting adapters		A	B	C	D
Description	Part no.	in	in	in	in
		mm	mm	mm	mm
2½" PEX x 3" IPS Groove	LFV2972530	2 <sup>13</sup> / <sub>16</sub>	1½	<sup>5</sup> / <sub>8</sub>	3½
		72	38	15	89
3" PEX x 2½" IPS Groove	LFV2973025	3 <sup>3</sup> / <sub>8</sub>	1½	<sup>5</sup> / <sub>8</sub>	3 <sup>13</sup> / <sub>16</sub>
		86	38	15	96
3" PEX x 3" IPS Groove	LFV2973030	3 <sup>3</sup> / <sub>8</sub>	1½	<sup>5</sup> / <sub>8</sub>	3 <sup>13</sup> / <sub>16</sub>
		86	38	15	96



ProPEX LF brass flange adapter		A	B	C	D
Description	Part no.	in	in	in	in
		mm	mm	mm	mm
2½" PEX x Flange	LF2982525	3¾	¾	2¹³⁄₁₆	7
		96	16	72	178
3" PEX x Flange	LF2983030	4⁵⁄₁₆	¾	4¹⁄₁₆	7½
		110	16	104	191

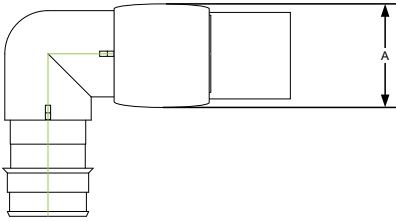


<b>ProPEX EP opposing-port tees</b>		<b>A</b>	<b>B</b>	<b>C</b>	<b>D</b>
<b>Description</b>	<b>Part no.</b>	<b>in</b>	<b>in</b>	<b>in</b>	<b>in</b>
		<b>mm</b>	<b>mm</b>	<b>mm</b>	<b>mm</b>
1" PEX x 1" PEX x ¾" PEX x ¾" PEX	Q4801075	1 <sup>3</sup> / <sub>16</sub>	1 <sup>5</sup> / <sub>16</sub>	2 <sup>1</sup> / <sub>16</sub>	1 <sup>5</sup> / <sub>8</sub>
		30	24	53	41
1¼" PEX x 1¼" PEX x ¾" PEX x ¾" PEX	Q4801375	1 <sup>7</sup> / <sub>16</sub>	1 <sup>5</sup> / <sub>16</sub>	2 <sup>3</sup> / <sub>8</sub>	1¾
		37	24	60	44
1½" PEX x 1½" PEX x ¾" PEX x ¾" PEX	Q4801575	1 <sup>11</sup> / <sub>16</sub>	1 <sup>5</sup> / <sub>16</sub>	2 <sup>11</sup> / <sub>16</sub>	1 <sup>5</sup> / <sub>8</sub>
		43	24	69	49
2" PEX x 2" PEX x ¾" PEX x ¾" PEX	Q4802075	2 <sup>3</sup> / <sub>16</sub>	1 <sup>5</sup> / <sub>16</sub>	3 <sup>3</sup> / <sub>16</sub>	2
		56	24	81	51

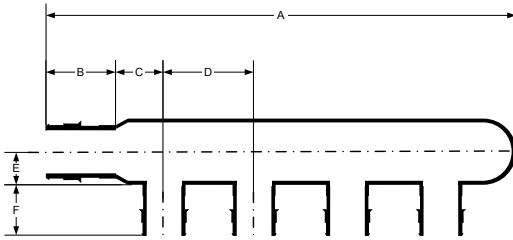


ProPEX brass ball valves		A	B	C	D	E	F	G	H
Description	Part no.	in	in	in	in	in	in	in	in
		mm	mm	mm	mm	mm	mm	mm	mm
½" PEX x ½" PEX	A3205050	2½ 64	1¹⁄₁₆ 18	1¹⁄₁₆ 27	¾ 10	½ 12	1¹¹⁄₁₆ 43	3³⁄₈ 86	¾ 10
	LFC4825050	2½ 64	1¹⁄₁₆ 18	1¹⁄₁₆ 27	¾ 10	½ 12	1¹¹⁄₁₆ 43	3³⁄₈ 86	¾ 10
¾" PEX x ¾" PEX	A3207575	3³⁄₈ 86	1⁵⁄₁₆ 24	1½ 38	½ 12	½ 12	1⁷⁄₈ 47	3³⁄₈ 86	¾ 10
	LFC4827575	3³⁄₈ 86	1⁵⁄₁₆ 24	1½ 38	½ 12	½ 12	1⁷⁄₈ 47	3³⁄₈ 86	¾ 10
1" PEX x 1" PEX	A3201010	4³⁄₁₆ 106	1³⁄₁₆ 30	1¹³⁄₁₆ 46	¾ 19	1³⁄₁₆ 20	1⁷⁄₈ 48	4⁷⁄₁₆ 114	½ 12
	LFC4821010	4³⁄₁₆ 106	1³⁄₁₆ 30	1¹³⁄₁₆ 46	¾ 19	1³⁄₁₆ 20	1⁷⁄₈ 48	4⁷⁄₁₆ 114	½ 12
1¼" PEX x 1¼" PEX	A3201313	4¹³⁄₁₆ 122	1⁷⁄₁₆ 37	1¹⁵⁄₁₆ 49	⁵⁄₈ 17	1⁵⁄₁₆ 24	2¼ 58	4⁷⁄₁₆ 114	½ 12
	LFC4821313	4¹³⁄₁₆ 122	1⁷⁄₁₆ 37	1¹⁵⁄₁₆ 49	⁵⁄₈ 17	1⁵⁄₁₆ 24	2¼ 58	4⁷⁄₁₆ 114	½ 12
1½" PEX x 1½" PEX	A3201515	5¹¹⁄₁₆ 145	1¹¹⁄₁₆ 43	2¹⁄₈ 58	1⁵⁄₁₆ 23	1¹⁄₈ 28	2¹¹⁄₁₆ 69	5⁹⁄₁₆ 142	⁹⁄₁₆ 14
	LFC4821515	5¹¹⁄₁₆ 145	1¹¹⁄₁₆ 43	2¹⁄₈ 58	1⁵⁄₁₆ 23	1¹⁄₈ 28	2¹¹⁄₁₆ 69	5⁹⁄₁₆ 142	⁹⁄₁₆ 14
2" PEX x 2" PEX	A3202020	7¹⁄₈ 181	2¹⁄₈ 55	2¹³⁄₁₆ 72	1¹⁄₈ 28	1⁷⁄₁₆ 37	3³⁄₈ 86	5⁹⁄₁₆ 142	⁹⁄₁₆ 14
	LFC4822020	7¹⁄₈ 181	2¹⁄₈ 55	2¹³⁄₁₆ 72	1¹⁄₈ 28	1⁷⁄₁₆ 37	3³⁄₈ 86	5⁹⁄₁₆ 142	⁹⁄₁₆ 14

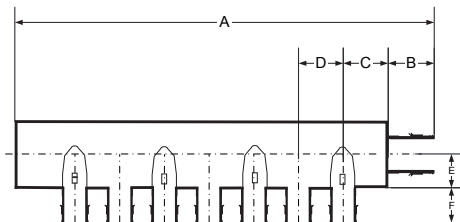




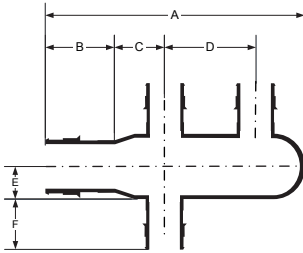
ProPEX ring installed diameter		A
Description	Part no.	in
		mm
½" ProPEX ring with stop	Q4690512	1 <sup>5</sup> / <sub>16</sub>
		24
¾" ProPEX ring with stop	Q4690756	1¼
		32
1" ProPEX ring with stop	Q4691000	1 <sup>9</sup> / <sub>16</sub>
		40
1¼" ProPEX ring with stop	Q4691250	1 <sup>13</sup> / <sub>16</sub>
		47
1½" ProPEX ring with stop	Q4691500	2 <sup>1</sup> / <sub>16</sub>
		53
2" ProPEX ring with stop	Q4692000	2 <sup>15</sup> / <sub>16</sub>
		74
2½" ProPEX ring with stop	Q4692500	3 <sup>9</sup> / <sub>16</sub>
		91
3" ProPEX ring with stop	Q4693000	4¼
		108



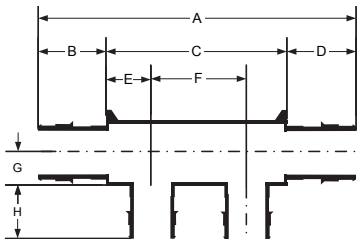
EP branch multiport tees		A	B	C	D	E	F
Description	Part no.	in	in	in	in	in	in
		mm	mm	mm	mm	mm	mm
¾" EP Branch Multiport Tee, 3 outlets	Q2237550	5 <sup>1</sup> / <sub>8</sub>	1 <sup>5</sup> / <sub>16</sub>	5 <sup>5</sup> / <sub>8</sub>	1 <sup>1</sup> / <sub>4</sub>	7 <sup>7</sup> / <sub>16</sub>	¾
		131	24	16	32	12	19
1¼" EP Branch Multiport Tee, 3 outlets	Q2231375	6 <sup>7</sup> / <sub>8</sub>	1 <sup>7</sup> / <sub>16</sub>	7 <sup>7</sup> / <sub>8</sub>	1 <sup>3</sup> / <sub>4</sub>	1 <sup>11</sup> / <sub>16</sub>	1 <sup>5</sup> / <sub>16</sub>
		174	37	23	44	18	24
¾" EP Branch Multiport Tee, 4 outlets	Q2247550	6 <sup>3</sup> / <sub>8</sub>	1 <sup>5</sup> / <sub>16</sub>	5 <sup>5</sup> / <sub>8</sub>	1 <sup>1</sup> / <sub>4</sub>	7 <sup>7</sup> / <sub>16</sub>	¾
		163	24	16	32	12	19
1" EP Branch Multiport Tee, 4 outlets	Q2241050	6 <sup>11</sup> / <sub>16</sub>	1 <sup>3</sup> / <sub>16</sub>	1 <sup>3</sup> / <sub>16</sub>	1 <sup>1</sup> / <sub>4</sub>	5 <sup>5</sup> / <sub>8</sub>	¾
		170	30	21	32	15	19
¾" EP Branch Multiport Tee, 6 outlets	Q2267550	8 <sup>7</sup> / <sub>8</sub>	1 <sup>5</sup> / <sub>16</sub>	5 <sup>5</sup> / <sub>8</sub>	1 <sup>1</sup> / <sub>4</sub>	7 <sup>7</sup> / <sub>16</sub>	¾
		226	24	16	32	12	19
1" EP Branch Multiport Tee, 6 outlets	Q2261050	9 <sup>1</sup> / <sub>4</sub>	1 <sup>3</sup> / <sub>16</sub>	5 <sup>5</sup> / <sub>8</sub>	1 <sup>1</sup> / <sub>4</sub>	9 <sup>9</sup> / <sub>16</sub>	¾
		235	30	16	32	14	19



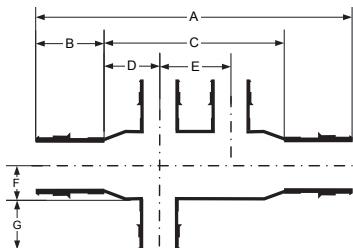
Commercial EP branch multiport tees		A	B	C	D	E	F
Description	Part no.	in	in	in	in	in	in
		mm	mm	mm	mm	mm	mm
¾" EP Branch Multiport Tee, 7 outlets	Q2277550	8 <sup>11</sup> / <sub>16</sub>	1 <sup>5</sup> / <sub>16</sub>	1 <sup>1</sup> / <sub>8</sub>	7 <sup>7</sup> / <sub>8</sub>	1 <sup>1</sup> / <sub>16</sub>	¾
		220	24	28	23	18	19
¾" EP Branch Multiport Tee, 8 outlets	Q2287550	9 <sup>9</sup> / <sub>16</sub>	1 <sup>5</sup> / <sub>16</sub>	1 <sup>1</sup> / <sub>8</sub>	7 <sup>7</sup> / <sub>8</sub>	1 <sup>1</sup> / <sub>16</sub>	¾
		243	24	28	23	18	19
1" EP Branch Multiport Tee, 7 outlets	Q2271051	8 <sup>7</sup> / <sub>8</sub>	1 <sup>3</sup> / <sub>16</sub>	1 <sup>1</sup> / <sub>8</sub>	7 <sup>7</sup> / <sub>8</sub>	1 <sup>1</sup> / <sub>16</sub>	¾
		226	30	28	23	18	19
1" EP Branch Multiport Tee, 8 outlets	Q2281051	9 <sup>5</sup> / <sub>16</sub>	1 <sup>3</sup> / <sub>16</sub>	1 <sup>1</sup> / <sub>8</sub>	7 <sup>7</sup> / <sub>8</sub>	1 <sup>1</sup> / <sub>16</sub>	¾
		249	30	28	23	18	19
1" EP Branch Multiport Tee, 10 outlets	Q2101051	11 <sup>9</sup> / <sub>16</sub>	1 <sup>3</sup> / <sub>16</sub>	1 <sup>1</sup> / <sub>8</sub>	7 <sup>7</sup> / <sub>8</sub>	1 <sup>1</sup> / <sub>16</sub>	¾
		294	30	28	23	18	19
1" EP Branch Multiport Tee, 12 outlets	Q2121051	13 <sup>3</sup> / <sub>8</sub>	1 <sup>3</sup> / <sub>16</sub>	1 <sup>1</sup> / <sub>8</sub>	7 <sup>7</sup> / <sub>8</sub>	1 <sup>1</sup> / <sub>16</sub>	¾
		340	30	28	23	18	19



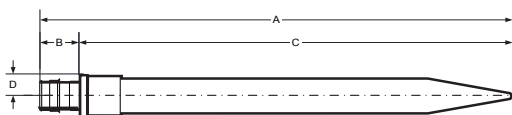
EP branch opposing-port multiport tees		A	B	C	D	E	F
Description	Part no.	in	in	in	in	in	in
		mm	mm	mm	mm	mm	mm
¾" EP Branch Opposing-port Multiport Tee, 3 outlets	Q2337550	3 <sup>9</sup> / <sub>16</sub>	1 <sup>5</sup> / <sub>16</sub>	5 <sup>5</sup> / <sub>8</sub>	1¼	7 <sup>7</sup> / <sub>16</sub>	¾
		91	24	16	32	11	19
¾" EP Branch Opposing-port Multiport Tee, 4 outlets	Q2347550	3 <sup>9</sup> / <sub>16</sub>	1 <sup>5</sup> / <sub>16</sub>	5 <sup>5</sup> / <sub>8</sub>	1¼	7 <sup>7</sup> / <sub>16</sub>	¾
		91	24	16	32	11	19
¾" EP Branch Opposing-port Multiport Tee, 8 outlets	Q2387550	6 <sup>1</sup> / <sub>16</sub>	1 <sup>5</sup> / <sub>16</sub>	5 <sup>5</sup> / <sub>8</sub>	1¼	7 <sup>7</sup> / <sub>16</sub>	¾
		154	24	16	32	11	19



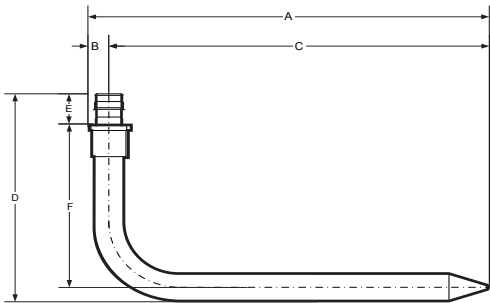
EP flow-through multiport tees		A	B	C	D	E	F	G	H
Description	Part no.	in	in	in	in	in	in	in	in
		mm	mm	mm	mm	mm	mm	mm	mm
2 outlets, ¾" x ¾"	Q2227557	4 <sup>9</sup> / <sub>8</sub>	1 <sup>5</sup> / <sub>16</sub>	2½	1 <sup>5</sup> / <sub>16</sub>	5 <sup>5</sup> / <sub>8</sub>	1¼	7 <sup>7</sup> / <sub>16</sub>	¾
		112	24	64	24	16	32	11	19
3 outlets, ¾" x ¾"	Q2237557	5 <sup>11</sup> / <sub>16</sub>	1 <sup>5</sup> / <sub>16</sub>	3¾	1 <sup>5</sup> / <sub>16</sub>	5 <sup>5</sup> / <sub>8</sub>	1¼	7 <sup>7</sup> / <sub>16</sub>	¾
		143	24	95	24	16	32	11	19
3 outlets, 1" x ¾"	Q2231057	6 <sup>3</sup> / <sub>16</sub>	1 <sup>3</sup> / <sub>16</sub>	4 <sup>1</sup> / <sub>16</sub>	1 <sup>5</sup> / <sub>16</sub>	¾	1¼	9 <sup>9</sup> / <sub>16</sub>	¾
		157	30	103	24	19	32	14	19
3 outlets, 1¼" x 1¼"	Q2231373	8 <sup>7</sup> / <sub>16</sub>	1 <sup>7</sup> / <sub>16</sub>	5 <sup>5</sup> / <sub>16</sub>	1 <sup>7</sup> / <sub>16</sub>	7 <sup>7</sup> / <sub>8</sub>	1¼	5 <sup>5</sup> / <sub>8</sub>	1
		208	37	135	37	23	44	17	25
3 outlets, 2" x 2"	Q2232102	10 <sup>5</sup> / <sub>8</sub>	2 <sup>3</sup> / <sub>16</sub>	6¼	2 <sup>3</sup> / <sub>16</sub>	1 <sup>1</sup> / <sub>8</sub>	2	1 <sup>5</sup> / <sub>16</sub>	1 <sup>5</sup> / <sub>16</sub>
		269	56	158	56	28	51	24	33
4 outlets, ¾" x ¾"	Q2247557	7 <sup>13</sup> / <sub>16</sub>	1 <sup>5</sup> / <sub>16</sub>	5 <sup>7</sup> / <sub>8</sub>	1 <sup>5</sup> / <sub>16</sub>	1 <sup>1</sup> / <sub>16</sub>	1½	7 <sup>7</sup> / <sub>16</sub>	¾
		198	24	150	24	18	38	11	19
4 outlets, 1" x ¾"	Q2241057	7 <sup>7</sup> / <sub>8</sub>	1 <sup>3</sup> / <sub>16</sub>	5	1 <sup>5</sup> / <sub>16</sub>	5 <sup>5</sup> / <sub>8</sub>	1¼	9 <sup>9</sup> / <sub>16</sub>	¾
		180	30	127	24	16	32	14	19
4 outlets, 1" x 1"	Q2241051	7 <sup>11</sup> / <sub>16</sub>	1 <sup>3</sup> / <sub>16</sub>	5 <sup>5</sup> / <sub>16</sub>	1 <sup>3</sup> / <sub>16</sub>	¾	1¼	9 <sup>9</sup> / <sub>16</sub>	¾
		195	30	135	30	19	32	14	19
6 outlets, ¾" x ¾"	Q2267557	9 <sup>3</sup> / <sub>8</sub>	1 <sup>5</sup> / <sub>16</sub>	7½	1 <sup>5</sup> / <sub>16</sub>	5 <sup>5</sup> / <sub>8</sub>	1¼	7 <sup>7</sup> / <sub>16</sub>	¾
		239	24	191	24	16	32	11	19
6 outlets, 1" x ¾"	Q2261057	9 <sup>5</sup> / <sub>8</sub>	1 <sup>3</sup> / <sub>16</sub>	7½	1 <sup>5</sup> / <sub>16</sub>	5 <sup>5</sup> / <sub>8</sub>	1¼	9 <sup>9</sup> / <sub>16</sub>	¾
		244	30	191	24	16	32	14	19
6 outlets, 1" x 1"	Q2261051	9 <sup>7</sup> / <sub>8</sub>	1 <sup>3</sup> / <sub>16</sub>	7½	1 <sup>3</sup> / <sub>16</sub>	5 <sup>5</sup> / <sub>8</sub>	1¼	9 <sup>9</sup> / <sub>16</sub>	¾
		251	30	191	30	16	32	14	19



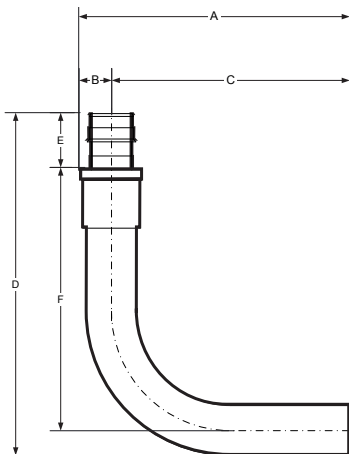
EP flow-through opposing-port multiport tees		A	B	C	D	E	F	G
Description	Part no.	in	in	in	in	in	in	in
		mm	mm	mm	mm	mm	mm	mm
3 outlets, ¾" x ¾"	Q2337557	4 <sup>7</sup> / <sub>16</sub>	1 <sup>5</sup> / <sub>16</sub>	2½	5 <sup>5</sup> / <sub>8</sub>	1¼	½	¾
		112	24	63	16	32	12	19
4 outlets, ¾" x ¾"	Q2347557	4 <sup>7</sup> / <sub>16</sub>	1 <sup>5</sup> / <sub>16</sub>	2½	5 <sup>5</sup> / <sub>8</sub>	1¼	½	¾
		112	24	63	16	32	12	19
6 outlets, ¾" x ¾"	Q2367557	5 <sup>11</sup> / <sub>16</sub>	1 <sup>5</sup> / <sub>16</sub>	3¾	5 <sup>5</sup> / <sub>8</sub>	1¼	½	¾
		144	24	95	16	32	12	19



ProPEX LF copper straight stubs		A	B	C	D
Description	Part no.	in	in	in	in
		mm	mm	mm	mm
½" PEX LF Brass x ½" Copper, 8"	LF2935050	8 <sup>5</sup> / <sub>16</sub>	1 <sup>1</sup> / <sub>16</sub>	7 <sup>9</sup> / <sub>16</sub>	3 <sup>3</sup> / <sub>8</sub>
		211	18	193	10
½" PEX LF Brass x ½" Copper, 15"	LF2945050	14½	1 <sup>1</sup> / <sub>16</sub>	13 <sup>13</sup> / <sub>16</sub>	3 <sup>3</sup> / <sub>8</sub>
		368	18	350	10
2½" PEX LF Brass x 2½" Copper	LF2962525	12 <sup>1</sup> / <sub>8</sub>	2 <sup>13</sup> / <sub>16</sub>	9¼	1 <sup>13</sup> / <sub>16</sub>
		308	72	236	46
3" PEX LF Brass x 3" Copper	LF2963030	13 <sup>11</sup> / <sub>16</sub>	3 <sup>3</sup> / <sub>8</sub>	10 <sup>9</sup> / <sub>16</sub>	2 <sup>7</sup> / <sub>8</sub>
		347	86	261	53

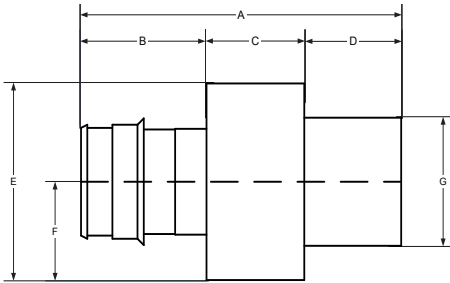


ProPEX LF copper stub ells		A	B	C	D	E	F
Description	Part no.	in	in	in	in	in	in
		mm	mm	mm	mm	mm	mm
½" PEX LF Brass x ½" Copper, 3½" x 8"	LF2865050	8 <sup>3</sup> / <sub>8</sub>	3 <sup>3</sup> / <sub>8</sub>	8	4 <sup>3</sup> / <sub>4</sub>	1 <sup>1</sup> / <sub>16</sub>	3 <sup>3</sup> / <sub>4</sub>
		213	10	203	121	18	95
½" PEX LF Brass x ½" Copper, 13" x 8"	LF2855050	8 <sup>3</sup> / <sub>8</sub>	3 <sup>3</sup> / <sub>8</sub>	8	13 <sup>5</sup> / <sub>16</sub>	1 <sup>1</sup> / <sub>16</sub>	12 <sup>5</sup> / <sub>16</sub>
		213	10	203	338	18	312
½" PEX LF Brass x ½" Copper, 8" x 13"	LF2895050	13 <sup>3</sup> / <sub>8</sub>	3 <sup>3</sup> / <sub>8</sub>	13	13 <sup>5</sup> / <sub>16</sub>	1 <sup>1</sup> / <sub>16</sub>	7 <sup>5</sup> / <sub>16</sub>
		340	10	330	338	18	185
¾" PEX LF Brass x ¾" Copper, 4" x 8"	LF2897575	8 <sup>9</sup> / <sub>16</sub>	9 <sup>9</sup> / <sub>16</sub>	8	5 <sup>7</sup> / <sub>16</sub>	1 <sup>5</sup> / <sub>16</sub>	4 <sup>1</sup> / <sub>16</sub>
		217	14	203	138	24	103
1" PEX LF Brass x 1" Copper, 12" x 12"	LF2891010	13 <sup>11</sup> / <sub>16</sub>	1 <sup>1</sup> / <sub>16</sub>	13	16	1 <sup>3</sup> / <sub>16</sub>	14 <sup>1</sup> / <sub>4</sub>
		347	17	330	406	30	362

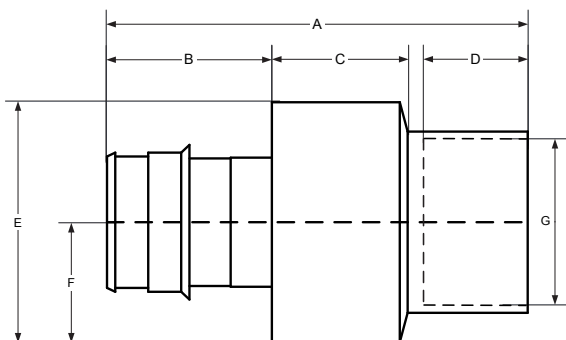


ProPEX LF copper tub ells		A	B	C	D	E	F
Description	Part no.	in	in	in	in	in	in
		mm	mm	mm	mm	mm	mm
½" PEX LF Brass x ½" Copper, 3" x 6"	LF2875050	3 <sup>3</sup> / <sub>8</sub>	3 <sup>3</sup> / <sub>8</sub>	3	6 <sup>5</sup> / <sub>16</sub>	1 <sup>1</sup> / <sub>16</sub>	5¼
		86	10	76	160	18	134
½" PEX LF Brass x ½" Copper, 3" x 4"	LF2885050	3 <sup>3</sup> / <sub>8</sub>	3 <sup>3</sup> / <sub>8</sub>	3	4 <sup>5</sup> / <sub>16</sub>	1 <sup>1</sup> / <sub>16</sub>	3¼
		86	10	76	109	18	83

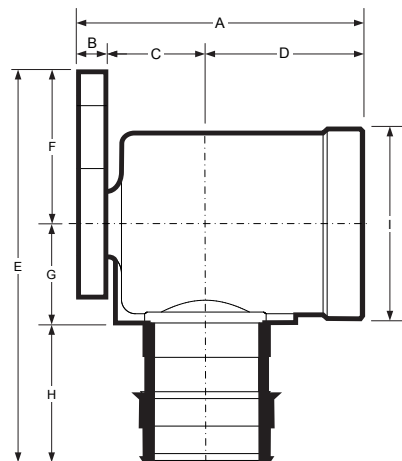




ProPEX LF brass CPVC spigot adapters		A	B	C	D	E	F	G
Description	Part no.	in	in	in	in	in	in	in
		mm	mm	mm	mm	mm	mm	mm
1¼" PEX x 1¼" CPVC (CTS)	CP4501313	3 <sup>11</sup> / <sub>16</sub>	1 <sup>7</sup> / <sub>16</sub>	1 <sup>1</sup> / <sub>8</sub>	1 <sup>1</sup> / <sub>8</sub>	2 <sup>1</sup> / <sub>8</sub>	1 <sup>1</sup> / <sub>16</sub>	*
		94	37	29	29	54	27	35
1½" PEX x 1½" CPVC (CTS)	CP4501515	4 <sup>3</sup> / <sub>16</sub>	1 <sup>11</sup> / <sub>16</sub>	1 <sup>3</sup> / <sub>16</sub>	1 <sup>5</sup> / <sub>16</sub>	2 <sup>3</sup> / <sub>8</sub>	1 <sup>3</sup> / <sub>16</sub>	1 <sup>5</sup> / <sub>8</sub>
		107	43	30	34	61	30	41
2" PEX x 2" CPVC (CTS)	CP4502020	5 <sup>3</sup> / <sub>16</sub>	2 <sup>3</sup> / <sub>16</sub>	1 <sup>7</sup> / <sub>16</sub>	1 <sup>3</sup> / <sub>4</sub>	3	1½	2 <sup>1</sup> / <sub>8</sub>
		134	56	36	44	76	38	54



<b>ProPEX LF brass CPVC socket adapters</b>		<b>A</b>	<b>B</b>	<b>C</b>	<b>D</b>	<b>E</b>	<b>F</b>	<b>G</b>
<b>Description</b>	<b>Part no.</b>	<b>in</b>	<b>in</b>	<b>in</b>	<b>in</b>	<b>in</b>	<b>in</b>	<b>in</b>
		<b>mm</b>	<b>mm</b>	<b>mm</b>	<b>mm</b>	<b>mm</b>	<b>mm</b>	<b>mm</b>
1¼" PEX x 1¼" CPVC (CTS)	CP4511313	3 <sup>11</sup> / <sub>16</sub>	1 <sup>7</sup> / <sub>16</sub>	1¼	1	2 <sup>1</sup> / <sub>8</sub>	1 <sup>1</sup> / <sub>16</sub>	1 <sup>3</sup> / <sub>8</sub>
		94	37	32	26	54	27	35
1½" PEX x 1½" CPVC (CTS)	CP4511515	4 <sup>3</sup> / <sub>16</sub>	1 <sup>11</sup> / <sub>16</sub>	1¼	1 <sup>5</sup> / <sub>16</sub>	2 <sup>3</sup> / <sub>8</sub>	1 <sup>3</sup> / <sub>16</sub>	1 <sup>5</sup> / <sub>8</sub>
		106	43	32	33	61	30	42
2" PEX x 2" CPVC (CTS)	CP4512020	5 <sup>3</sup> / <sub>16</sub>	2 <sup>3</sup> / <sub>16</sub>	1 <sup>3</sup> / <sub>8</sub>	2	3	1½	2 <sup>1</sup> / <sub>8</sub>
		133	56	35	43	76	38	54



ProPEX LF brass drop ear elbow		A	B	C	D	E	F	G	H	I
Description	Part no.	in	in	in	in	in	in	in	in	in
		mm	mm	mm	mm	mm	mm	mm	mm	mm
½" PEX x ½" FIP	LF4235050	1 <sup>11</sup> / <sub>16</sub>	¼	7 <sup>7</sup> / <sub>16</sub>	1	2 <sup>3</sup> / <sub>16</sub>	1	9 <sup>9</sup> / <sub>16</sub>	1 <sup>11</sup> / <sub>16</sub>	1 <sup>11</sup> / <sub>16</sub>
		43	6	11	26	56	26	14	18	26
¾" PEX x ¾" FIP	LF4237575	1 <sup>15</sup> / <sub>16</sub>	¼	¾	1	2 <sup>3</sup> / <sub>16</sub>	1 <sup>3</sup> / <sub>16</sub>	1 <sup>11</sup> / <sub>16</sub>	1 <sup>15</sup> / <sub>16</sub>	1 <sup>3</sup> / <sub>8</sub>
		49	6	19	26	56	29	17	24	35
1" PEX x ¾" FIP	LF4231010	2 <sup>7</sup> / <sub>16</sub>	¼	7 <sup>7</sup> / <sub>8</sub>	1¼	3 <sup>5</sup> / <sub>16</sub>	1 <sup>5</sup> / <sub>16</sub>	7 <sup>7</sup> / <sub>8</sub>	1 <sup>3</sup> / <sub>16</sub>	1 <sup>5</sup> / <sub>8</sub>
		62	6	22	32	84	33	22	30	42





**Moving  
> Water**

**Uponor**

**Uponor Inc.**

5925 148th Street West  
Apple Valley, MN 55124  
USA

T 800.321.4739

F 952.891.2008

[uponor.com](https://www.uponor.com)

**Uponor Ltd.**

6510 Kennedy Road  
Mississauga, ON L5T 2X4  
CANADA

T 888.994.7726

F 800.638.9517