

RainBlock Smart system

Uponor

EN: Installation Instructions

FI: Asennusohje

SE: Installationsanvisning

DK: Installationsvejledning

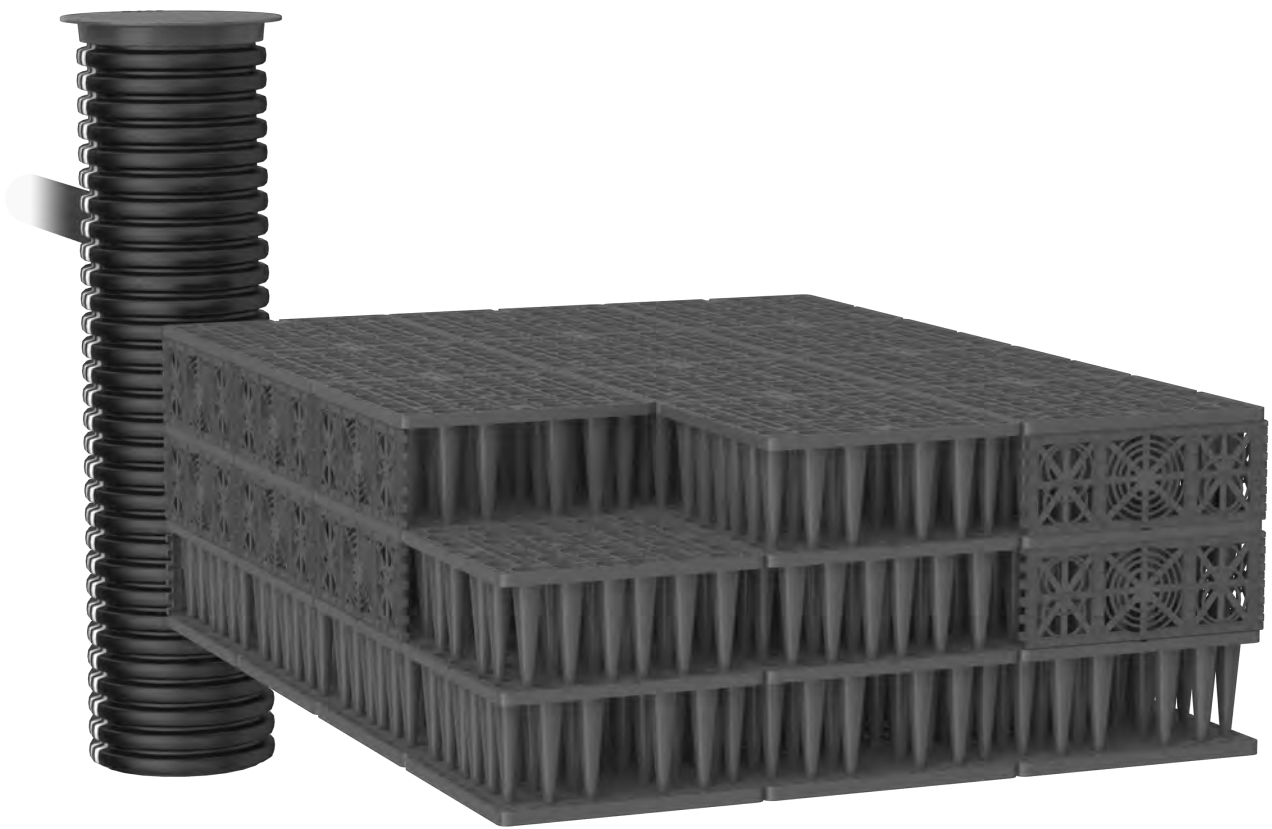

Installation Instructions | Asennusohjeet

Installationsanvisning | Installationsvejledning

1122168 INFILTRATION RAINBLOCK SMART 211L
 1122235 INFILTRATION RAINBLOCK SMART PLUS 211L
 1122236 INFILTRATION RAINBLOCK SMART ULTRA 211L

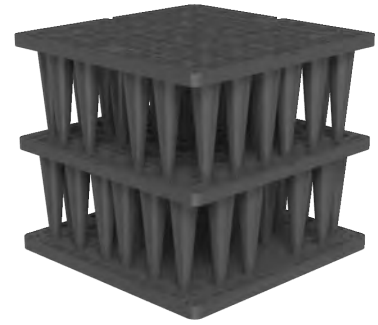



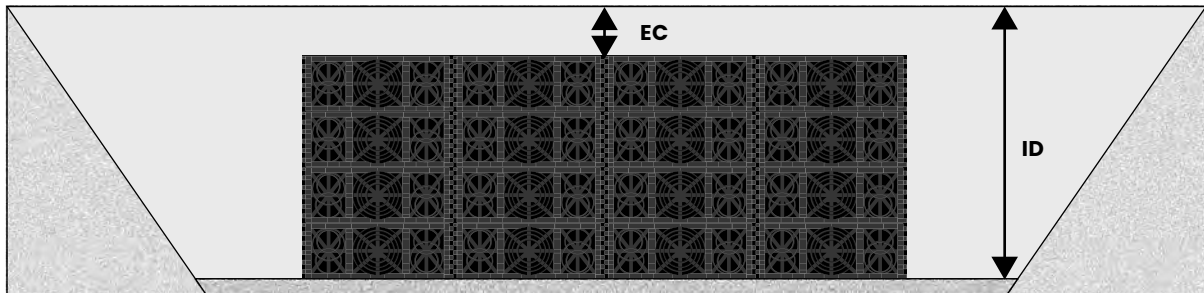

Installation window | Asennusolosuhteet

Installationsförhållanden | Installationsbetingelser



EC Earth covering | Peittosyvyys | Jordtäckning | Jorddække
 ID Installation depth | Asennussyvyys | Installationsdjup | Installationsdybde

RainBlock				
		Smart	Smart Plus	Smart Ultra
	Min. EC	250 mm	250 mm	250 mm
	Min. EC 40 t	500 mm	400 mm	300 mm
	Max. EC 40 t	2250 mm	2750 mm	4500 mm
	Max. ID	5000 mm	6000 mm	7500 mm

Use of construction machinery in the installation phase

Koneiden käyttö asennusvaiheessa

Användning av entreprenadmaskiner under installationsfas

Brug af entreprenørmaskiner i installationsprocessen

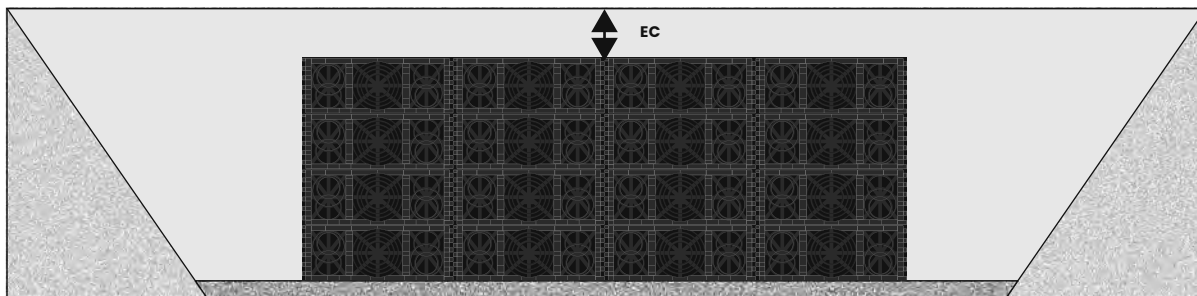

EC Earth covering | Peittosyvyys | Jordtäckning | Jorddække

RainBlock				
		Smart	Smart Plus	Smart Ultra
	Min. EC ~ 0,7 t	100 mm	100 mm	100 mm
	Min. EC ~ 2,5 t	200 mm	150 mm	100 mm
	Min. EC ~ 7,5 t	300 mm	250 mm	200 mm
	Min. EC ~ 12 t	500 mm	300 mm	250 mm
	Min. EC ~ 40 t	500 mm	400 mm	300 mm



Note! Compression equipment with active vibration motors must not be taken over the area.

Huom! Alueen päällä ei saa tehdä täryttävää maantiivistämistä.

Notera! Installationsutrustning med vibratorer får inte användas ovanpå kassetterna.

Bemærk! Bladvibrator til jordpakning må ikke anvendes på pladsen

Site of installation | Asennuspaikka
Installationsplatsen | Installationssted

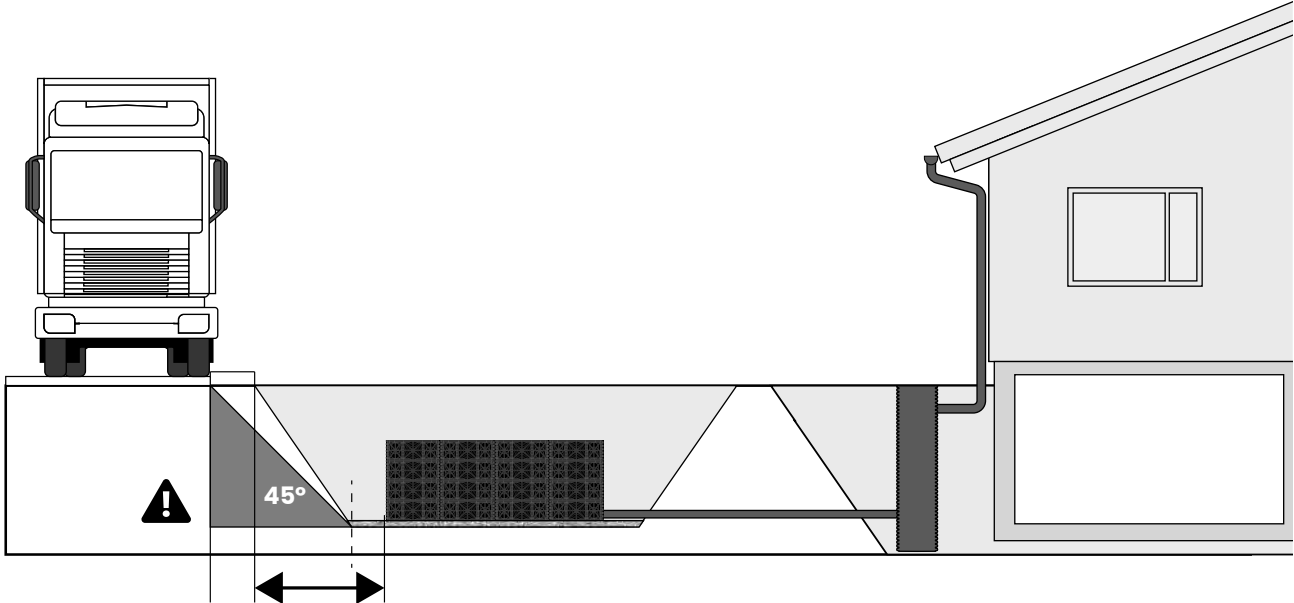
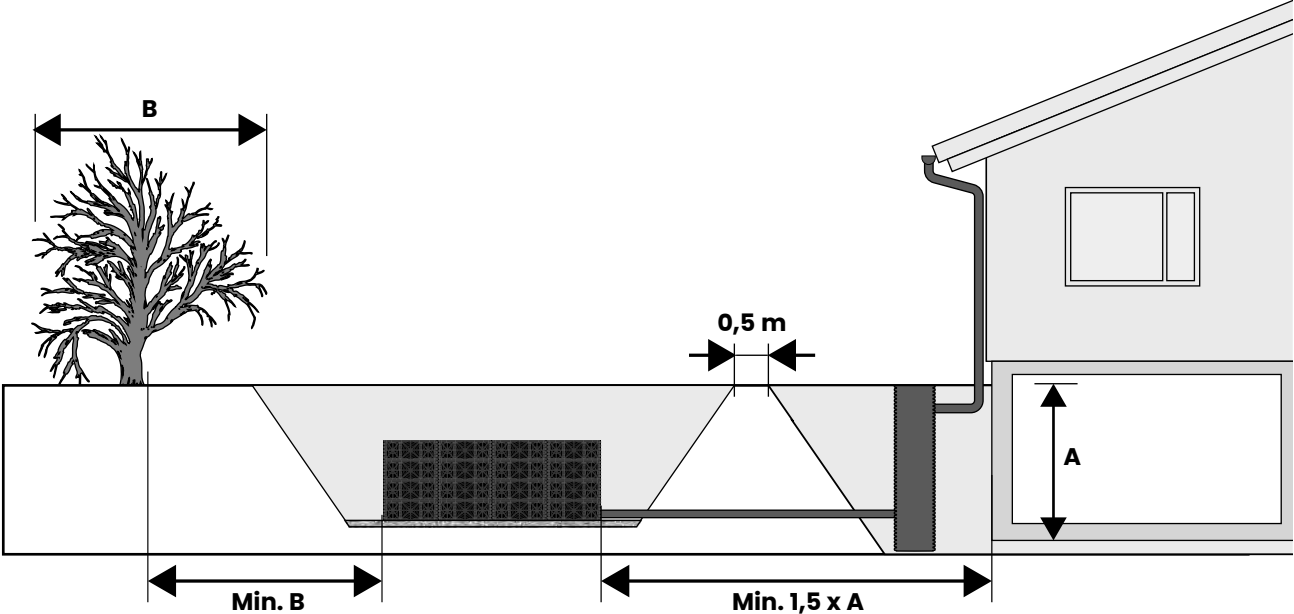

Tools and supplies | Työkalut ja tarvikkeet
Verktøy og utrustning | Værktøj og forsyninger

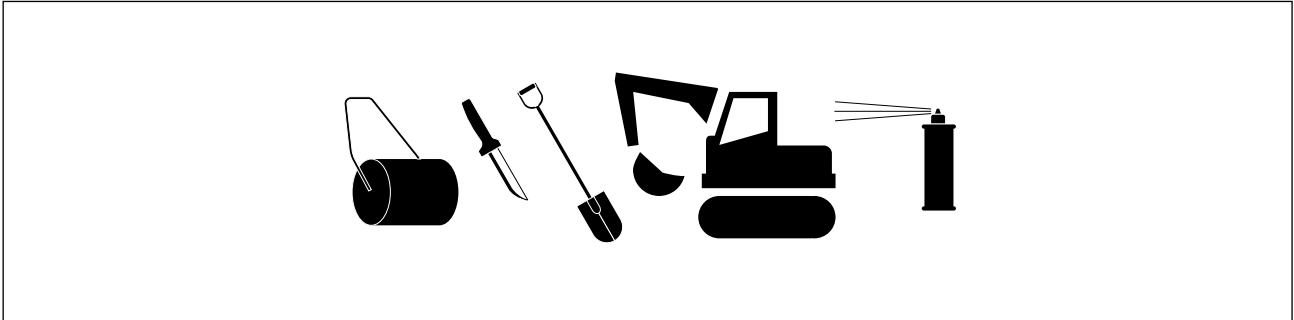

Product range | Tuotevalikoima Sortiment | Produktsortiment

**Blocks | Kasetit
Kassetter | Kassetter**

1122168
1122235
1122236

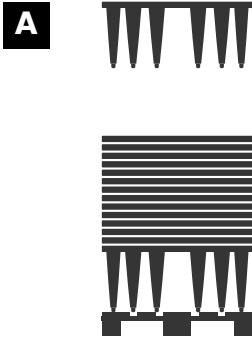

**Bottom plate | Pohjalevyt
Bottenplatta | Bundplader**

1122169

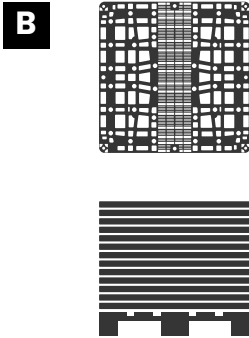

**Side plate | Sivulevyt
Sidoplatta | Sideplader**

1122170



**Connectors | Liittimet
Sprintar | Clips**

1085258

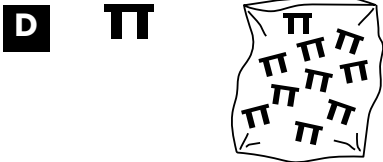

**Filter textile | Suodatinkangas
Geotextil | Filtertekstil**

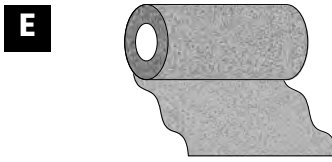

Installation and assembly | Asennus ja kokoonpano Installation och montering | Installation og montage

1

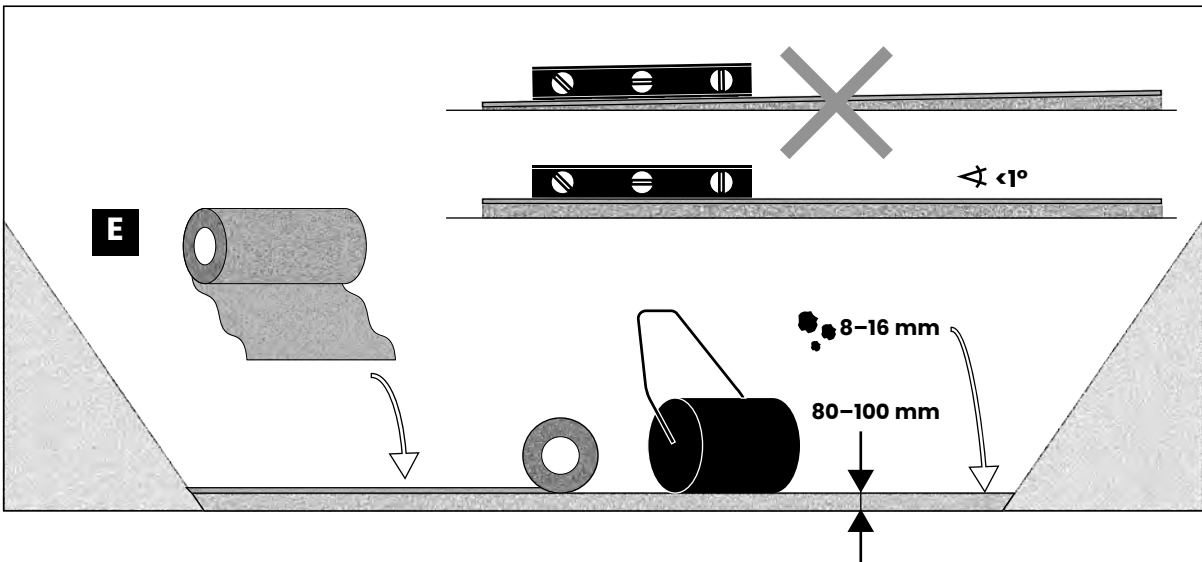

2

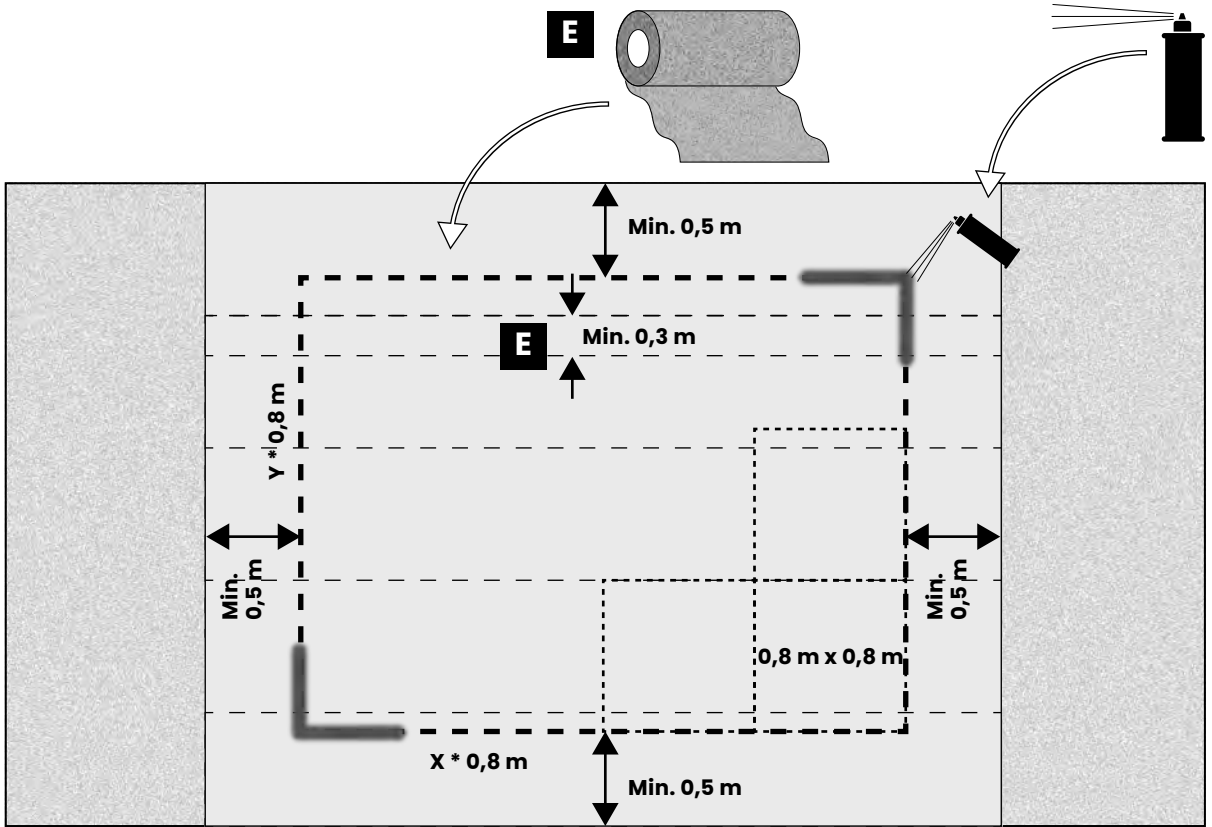

3

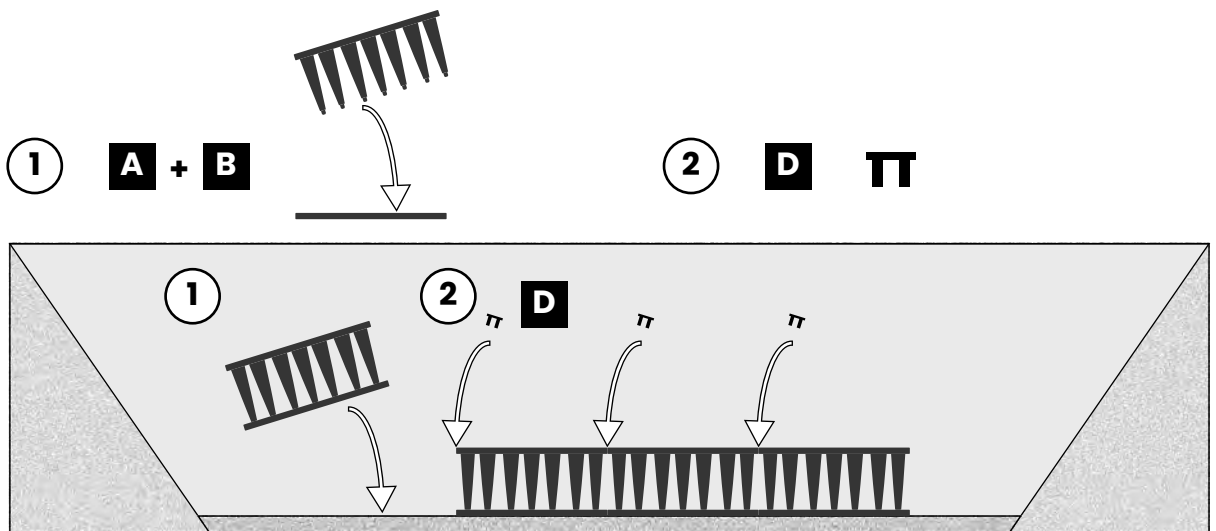

4

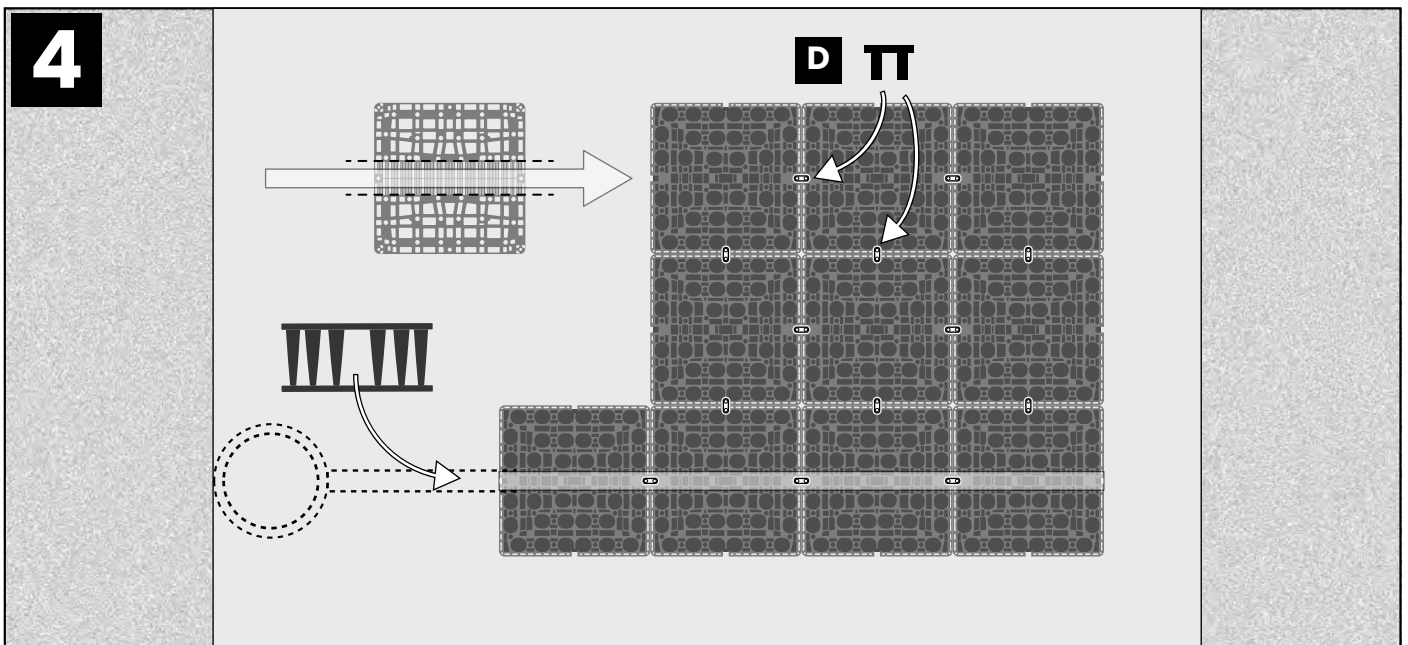

5

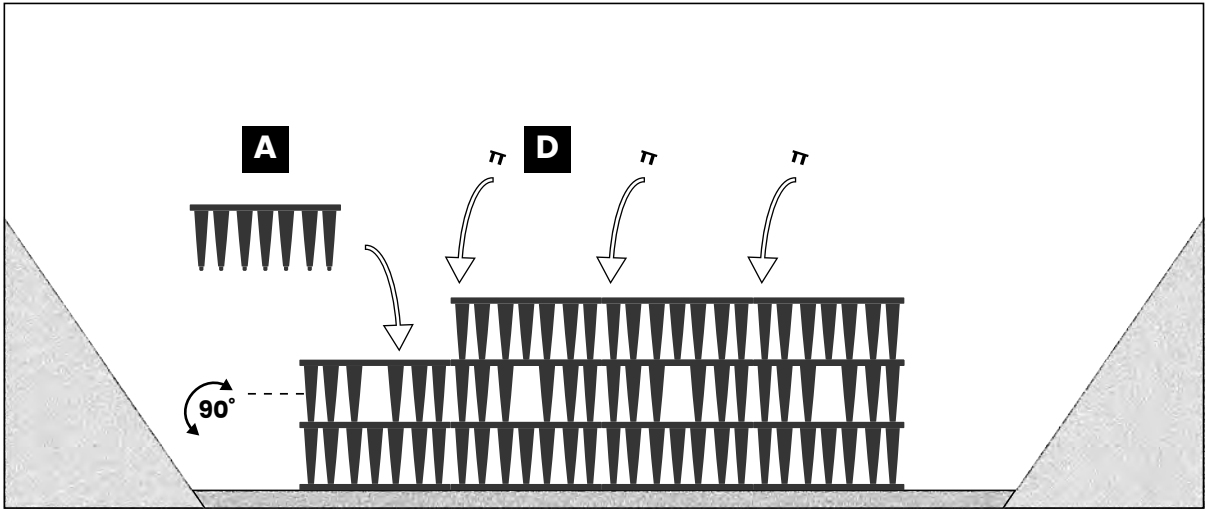

6

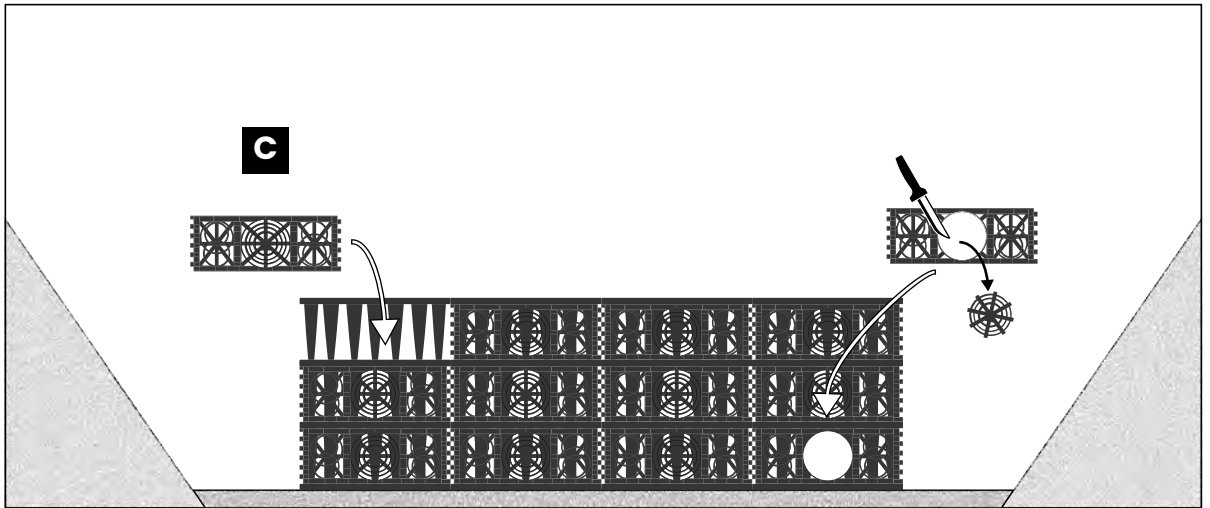

7

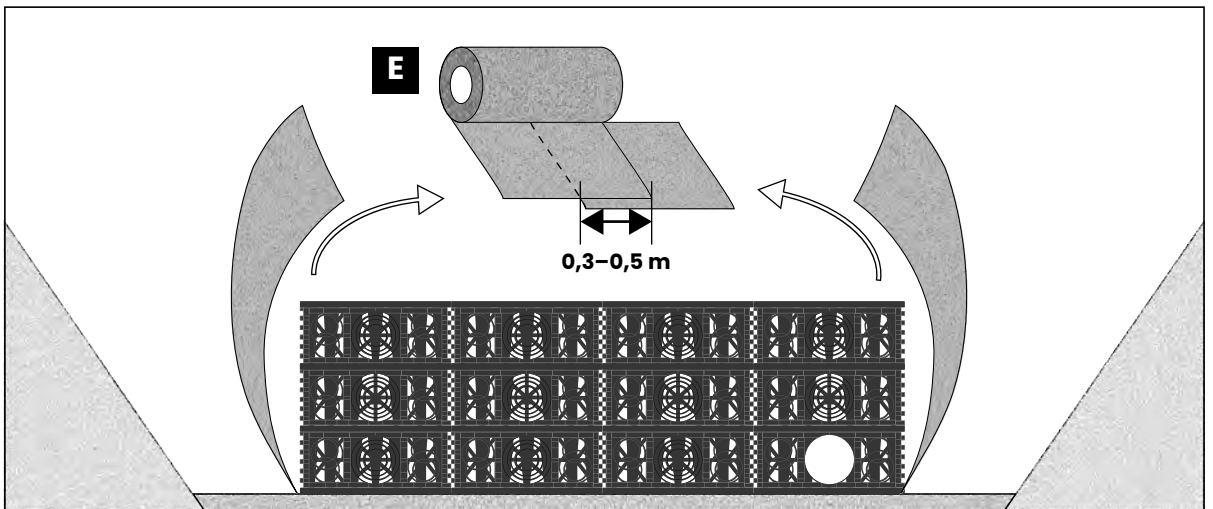

8

Alt. 1

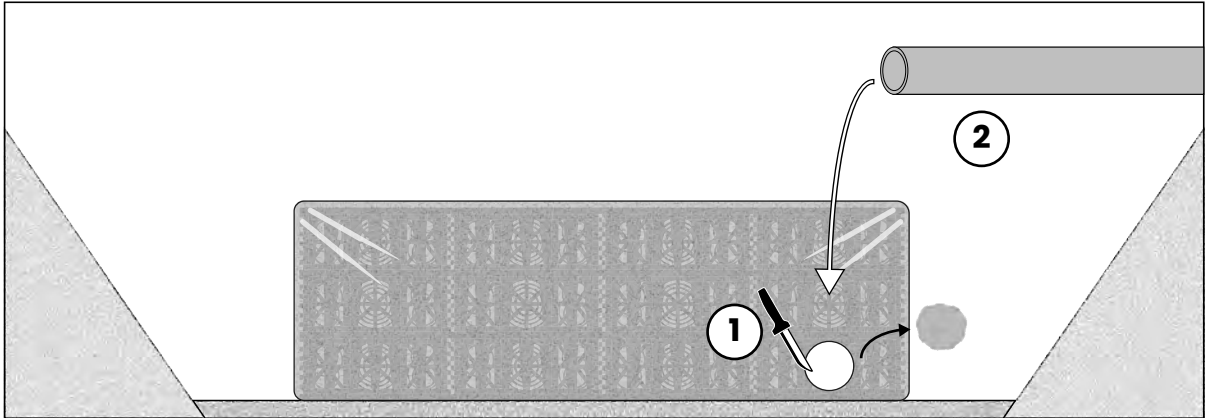

8

Alt. 2

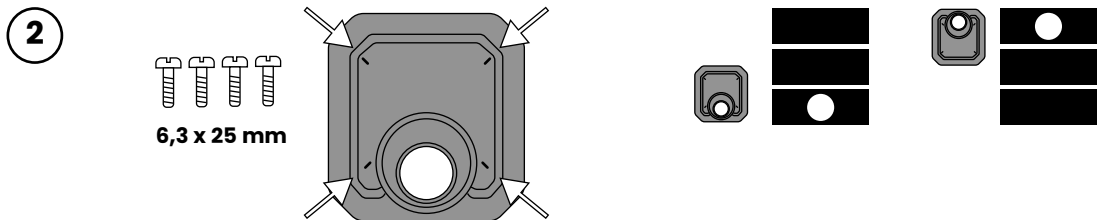
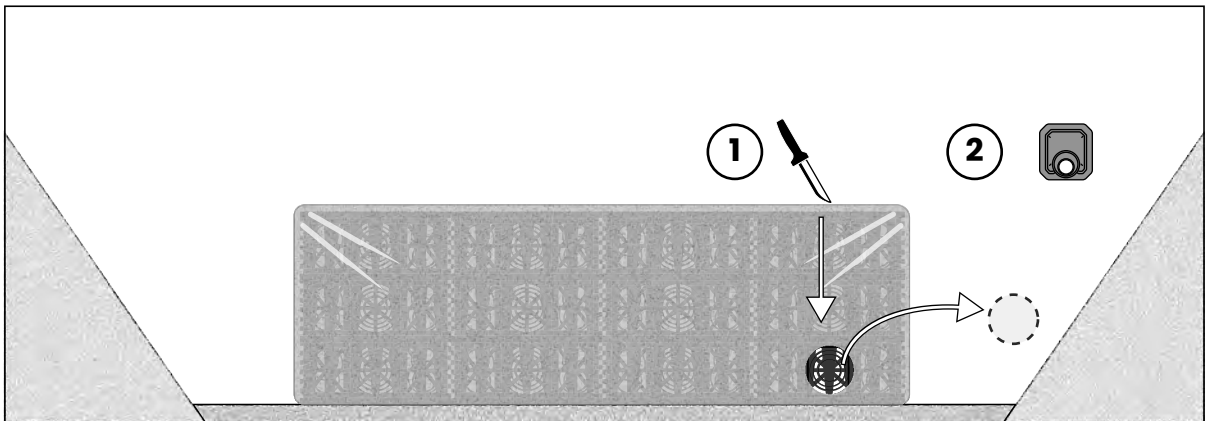

9

