



d_a [mm]	R_{min} [mm]
16	80
18	90
20	100
25	125
32	160

16 - 32 mm

d_a [mm]	R_{min} [mm]
16	64
18	72
20	80
25	100
32	128

16 - 25 mm

d_a [mm]	R_{min} [mm]
16	64
18	72
20	80
25	100

16 - 32 mm

d_a [mm]	R_{min} [mm]
16	46
18	52
20	80
25	83
32	111

$$\Delta l \text{ [mm]} = \Delta\vartheta \text{ [K]} \cdot 0,025 \text{ [mm/mK]} \cdot L \text{ [m]}$$

$$BS \text{ [mm]} = 30 \cdot \sqrt{d_a \text{ [mm]} \cdot \Delta l \text{ [mm]}}$$

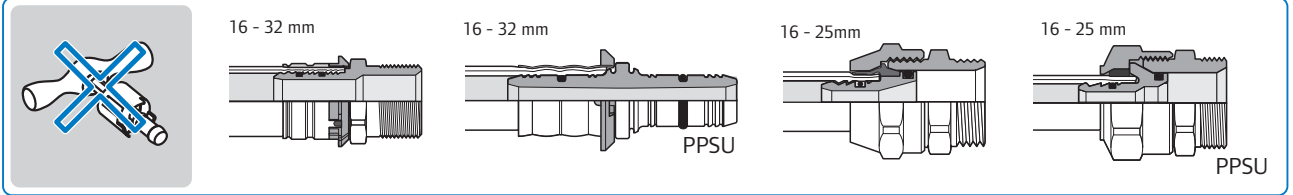

**Solo para los
accesorios RTM!**

only for Uponor
RTM fittings!

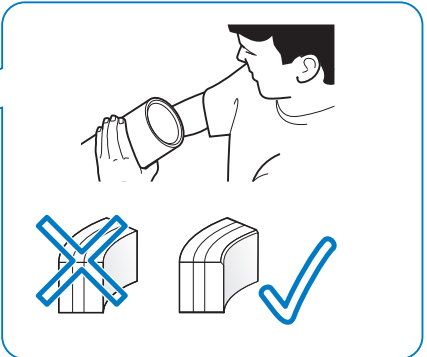
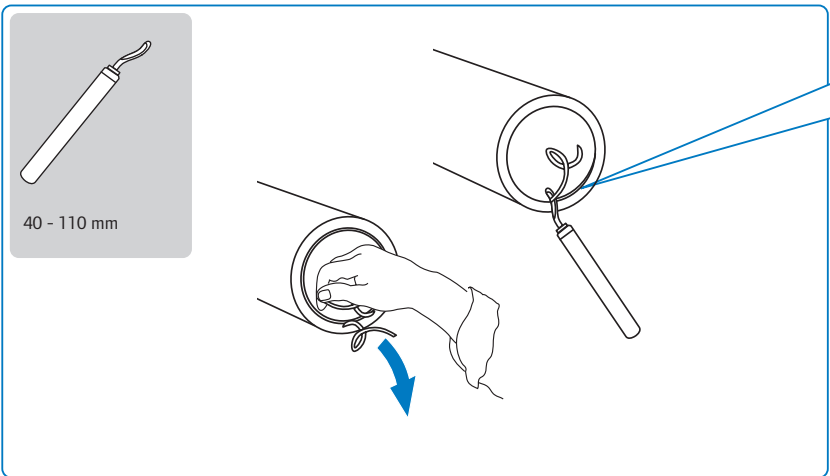
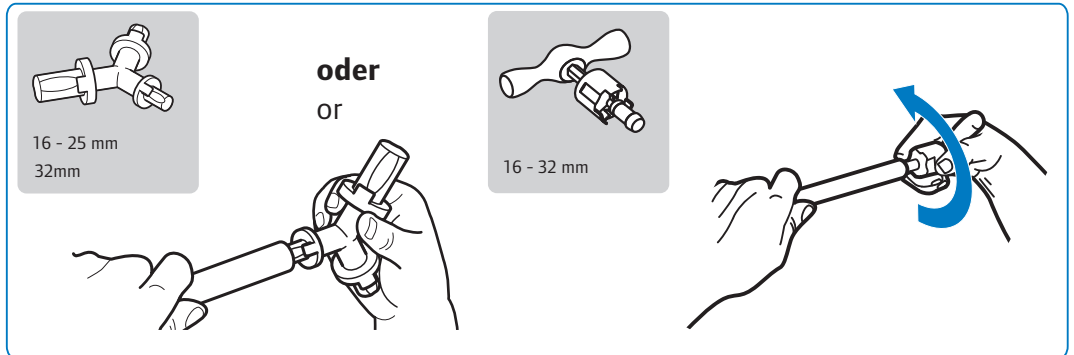
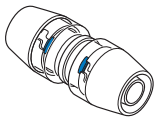



PPSU	16 - 20	16 - 32	40 - 50	-	16 - 32	-	-
	16 - 20	16 - 32	-	-	16 - 32	-	-
	-	-	40 - 50	-	-	-	-
	-					-	-
	-	25 - 32	40 - 50	63 - 110	25 - 32	-	-
	-	-	-	-	-	16 - 25	-
	-	-	-	-	-	-	16 - 32

16 - 50 mm

PPSU

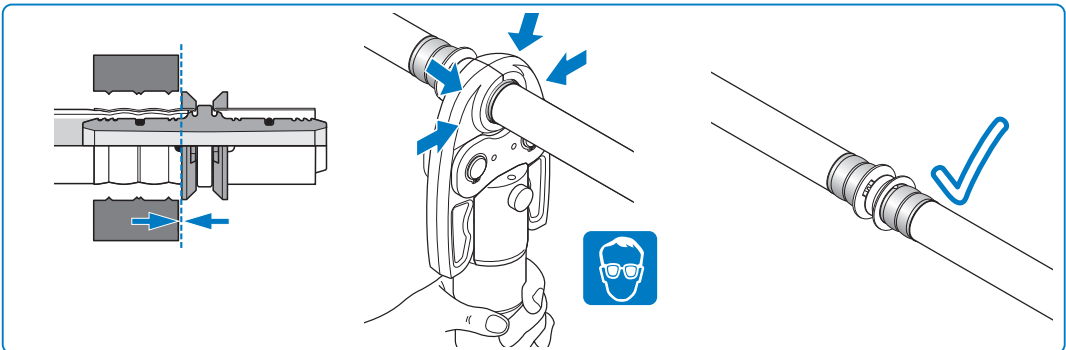
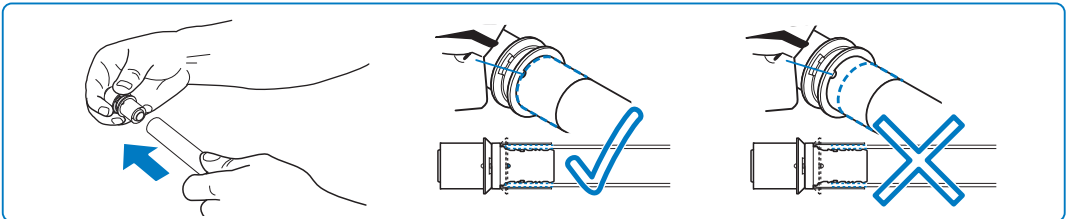

16 – 32 mm

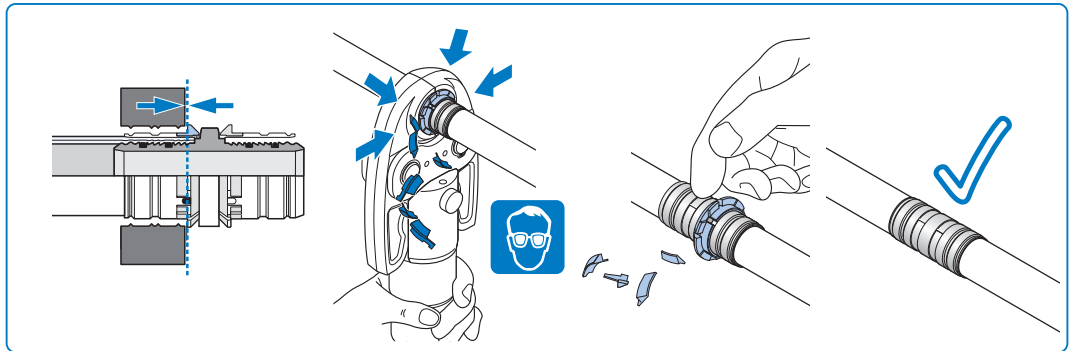
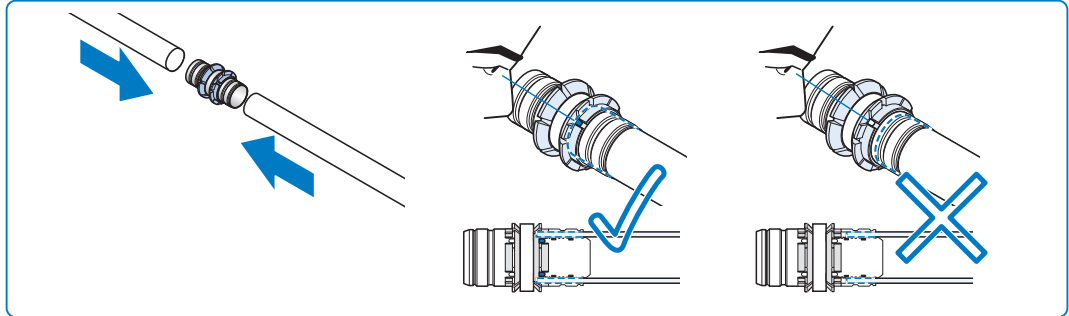
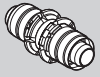

40 – 50 mm

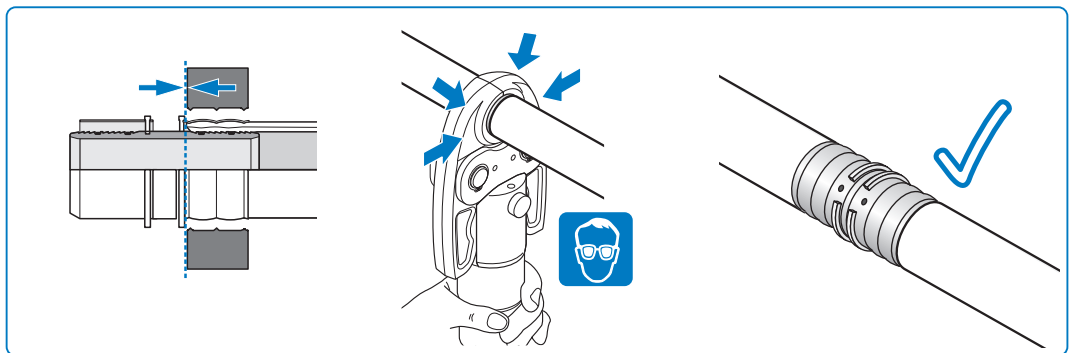
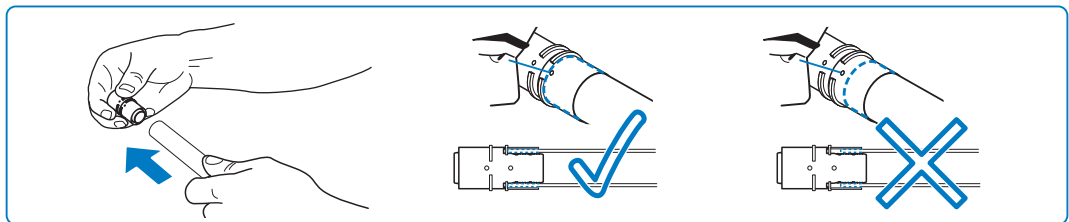
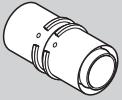

63 – 110 mm

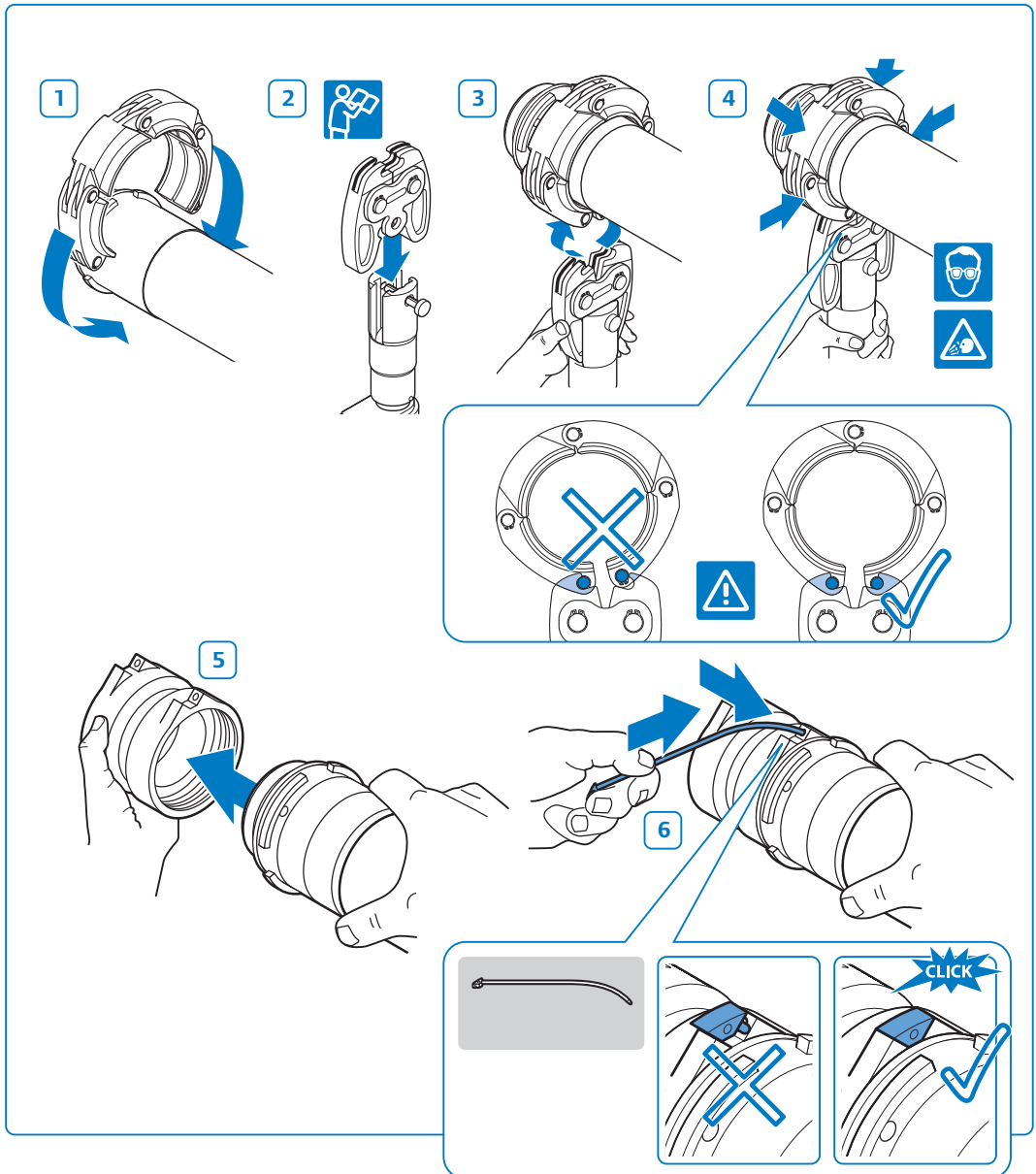
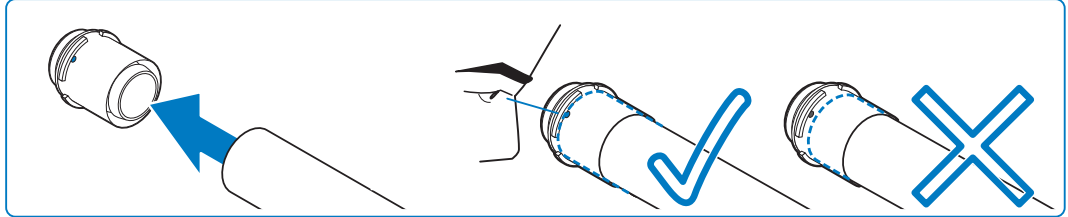
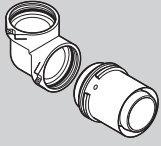

16 – 25 mm



PPSU

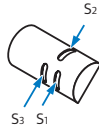
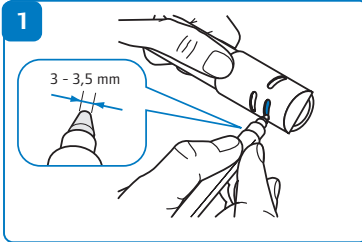

Fitting Dim.	S
16 – 1/2"	S ₁
18 – 1/2"	S ₂
20 – 1/2"	S ₂
20 – M 22	S ₁

Fitting Dim.	S
16 – 3/4"	S ₁
18 – 3/4"	S ₁
20 – 3/4"	S ₁
25 – 3/4"	S ₃

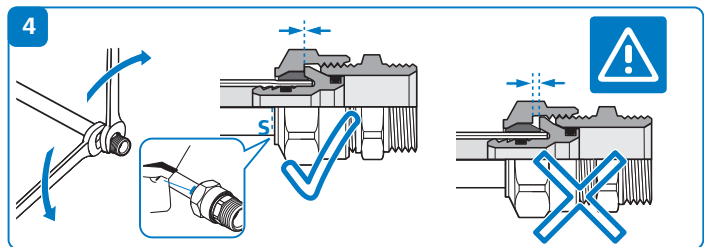
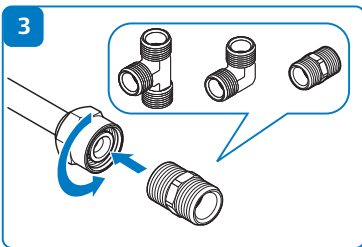
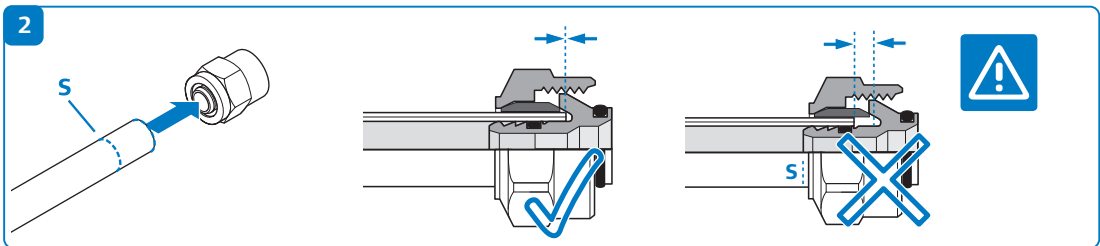

16 – 25 mm

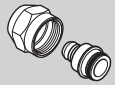

Metal

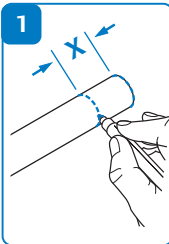

Fitting Dim.	X [mm]
16 – 1/2"	8
18 – 1/2"	9
20 – 1/2"	10

Fitting Dim.	X [mm]
16 – 3/4"	10
18 – 3/4"	10
20 – 3/4"	10
25 – 3/4"	11

Fitting Dim.	X [mm]
NL 16 – 15 mm	8
NL 18 – 15 mm	10
NL 20 – 22 mm	10
NL 25 – 22 mm	14

Fitting Dim.	X [mm]
16 – M 22	9
16 – M 24	9
16 – 1/2" Geberit	9

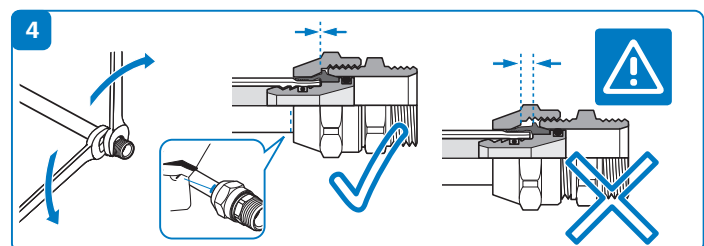
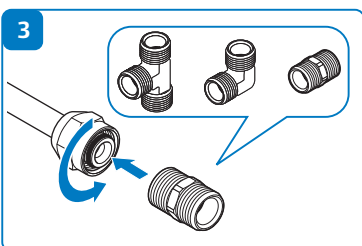
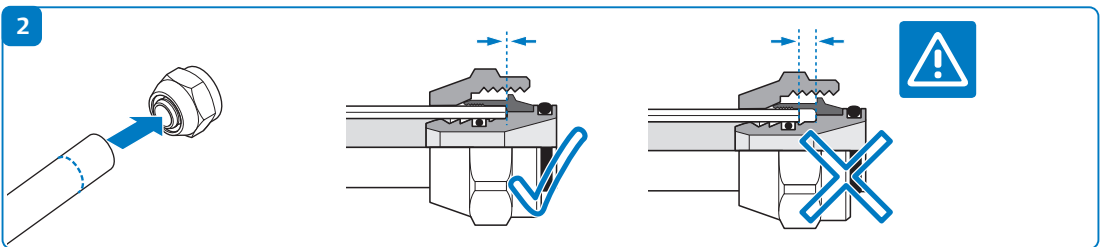

16 – 32 mm

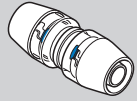

RTM

