



$d_a$ [mm]	$R_{min}$ [mm]
14	70
16	80
18	90
20	100
25	125
32	160

14 - 32 mm

$d_a$ [mm]	$R_{min}$ [mm]
14	56
16	64
18	72
20	80
25	100
32	128

14 - 25 mm

$d_a$ [mm]	$R_{min}$ [mm]
14	56
16	64
18	72
20	80
25	100

16 - 32 mm

$d_a$ [mm]	$R_{min}$ [mm]
16	46
18	52
20	80
25	83
32	111

$$\Delta l \text{ [mm]} = \Delta\theta \text{ [K]} \cdot 0,025 \text{ [mm/mK]} \cdot L \text{ [m]}$$

$$BS \text{ [mm]} = 30 \cdot \sqrt{d_a \text{ [mm]} \cdot \Delta l \text{ [mm]}}$$



14 - 32 mm

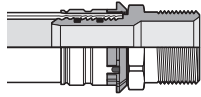

16 - 32 mm

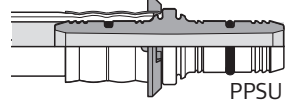

PPSU

14 - 25mm

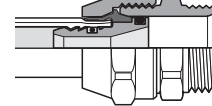

14 - 25 mm

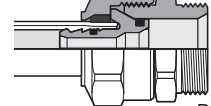

PPSU

**nur für Uponor  
RTM Fittings!**

only for Uponor  
RTM fittings!

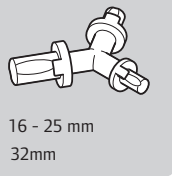
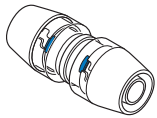

16 - 25 mm  
32mm

**oder  
OR**

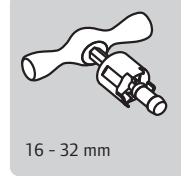

16 - 32 mm

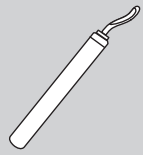
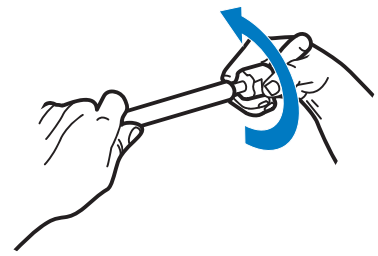
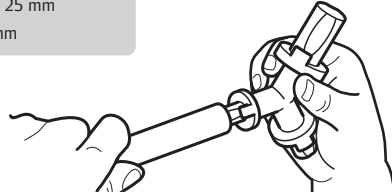

40 - 110 mm

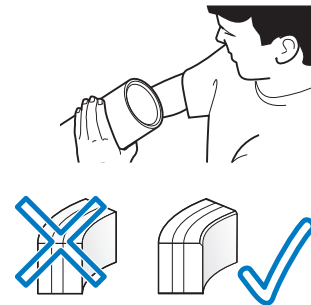
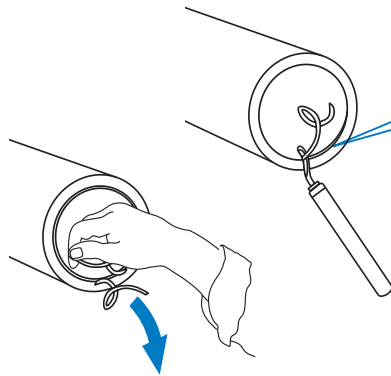



PPSU	14 - 20	16 - 32	40 - 50	-	16 - 32	-	-
	14 - 20	14 - 32	-	-	14 - 32	-	-
	-	-	40 - 50	-	-	-	-
	-					-	-
	-	25 - 32	40 - 50	63 - 110	25 - 32	-	-
	-	-	-	-	-	14 - 25	-
	-	-	-	-	-	-	16 - 32

16 - 50 mm

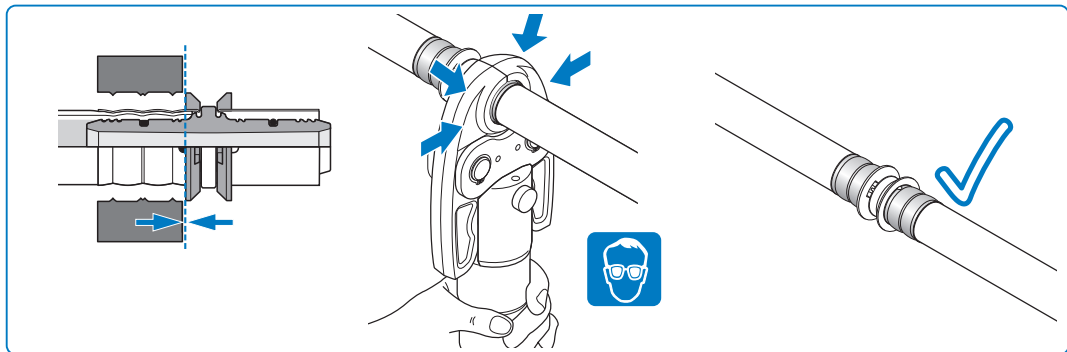
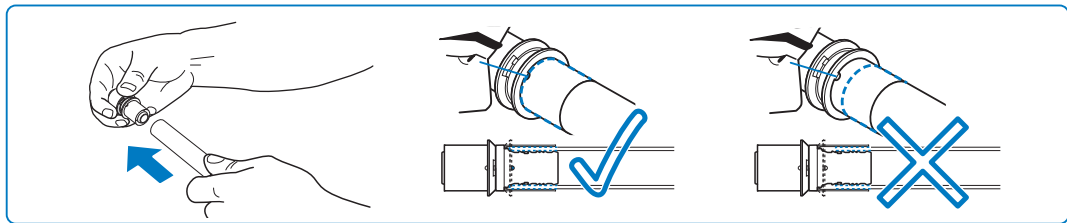
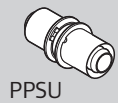

14 – 32 mm

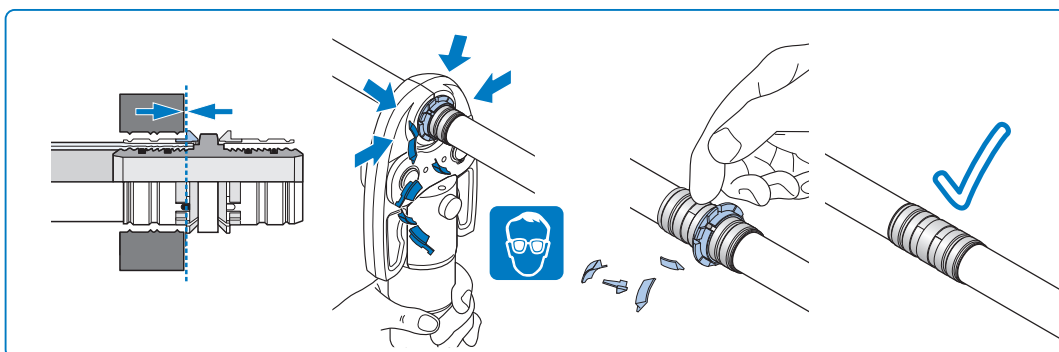
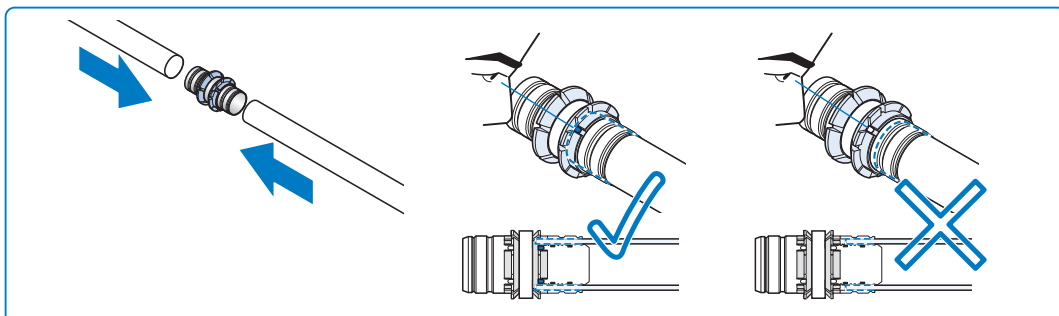

40 – 50 mm

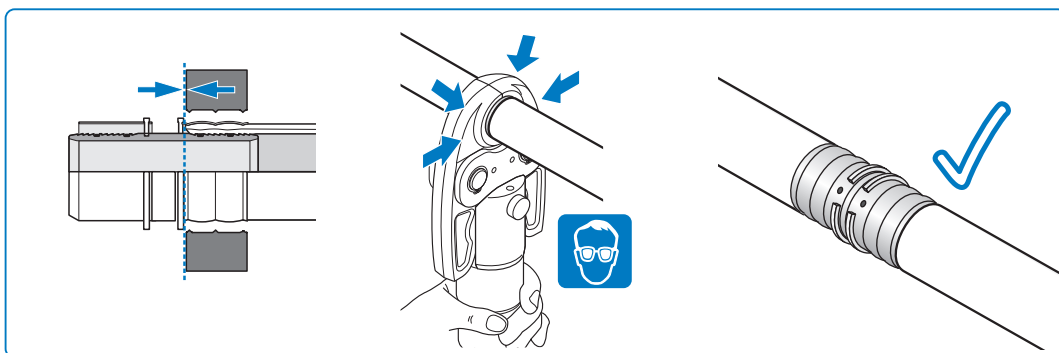
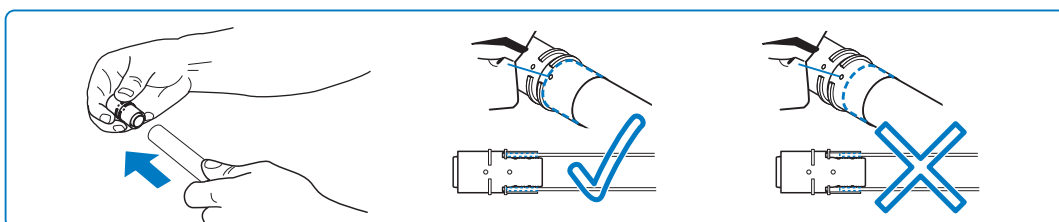
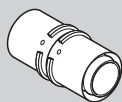

63 - 110 mm

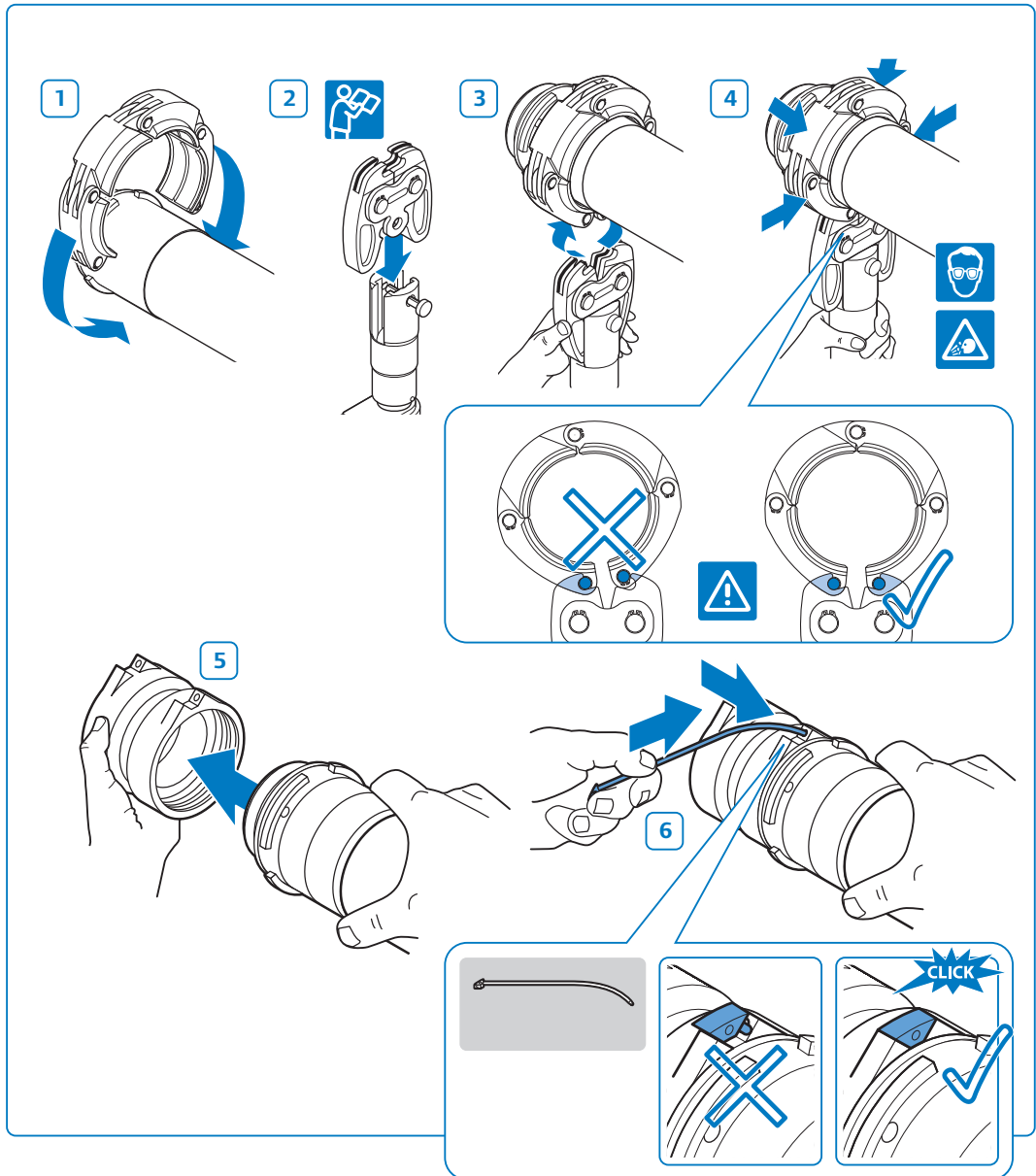
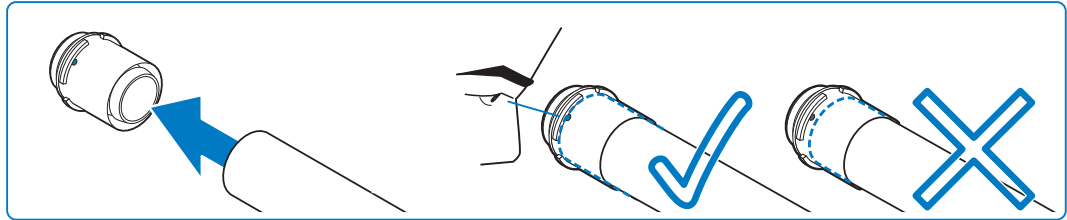
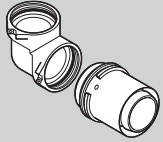

14 – 25 mm



PPSU

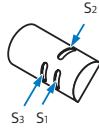
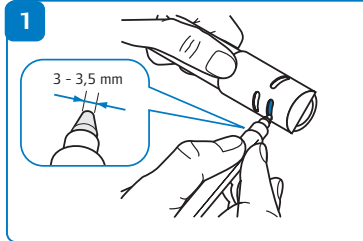

Fitting Dim.	S	Fitting Dim.	S
14 – 1/2"	S <sub>1</sub>	14 – 3/4"	S <sub>1</sub>
16 – 1/2"	S <sub>1</sub>	16 – 3/4"	S <sub>1</sub>
18 – 1/2"	S <sub>2</sub>	18 – 3/4"	S <sub>1</sub>
20 – 1/2"	S <sub>2</sub>	20 – 3/4"	S <sub>1</sub>
20 – M 22	S <sub>1</sub>	25 – 3/4"	S <sub>3</sub>

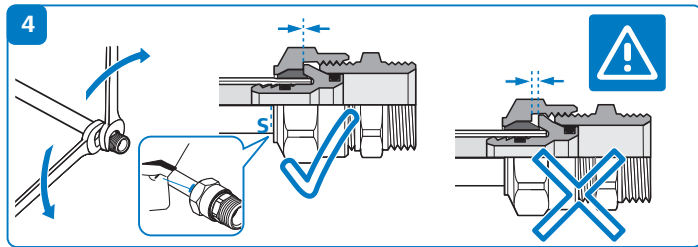
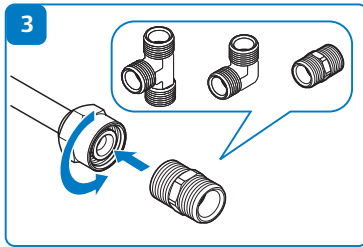
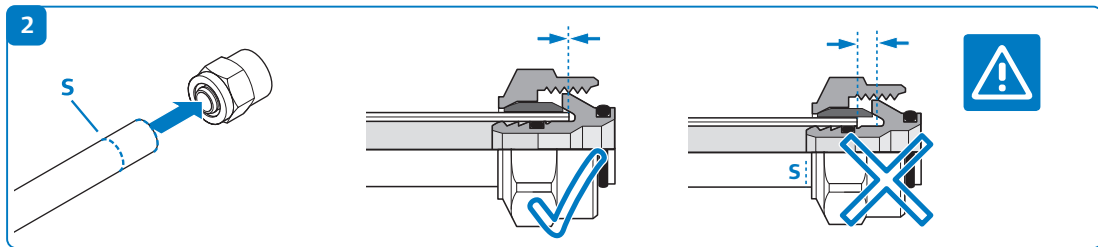

14 – 25 mm



Metal

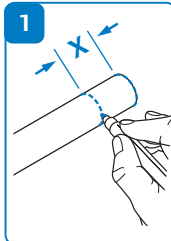

Fitting Dim.	X [mm]	Fitting Dim.	X [mm]	Fitting Dim.	X [mm]	Fitting Dim.	X [mm]
14 – 1/2"	8	14 – 3/4"	10	NL 14 – 15 mm	8	16 – M 22	9
16 – 1/2"	8	16 – 3/4"	10	NL 16 – 15 mm	8	16 – M 24	9
18 – 1/2"	9	18 – 3/4"	10	NL 18 – 15 mm	10	16 – 1/2"	9
20 – 1/2"	10	20 – 3/4"	10	NL 20 – 22 mm	10	Geberit	
		25 – 3/4"	11	NL 25 – 22 mm	14		

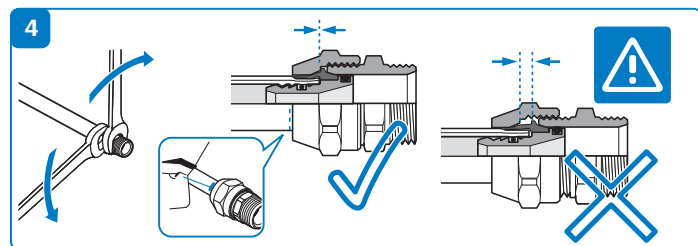
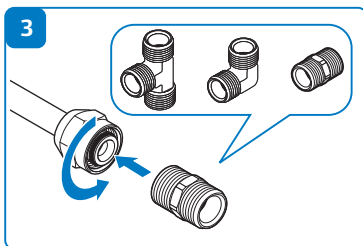
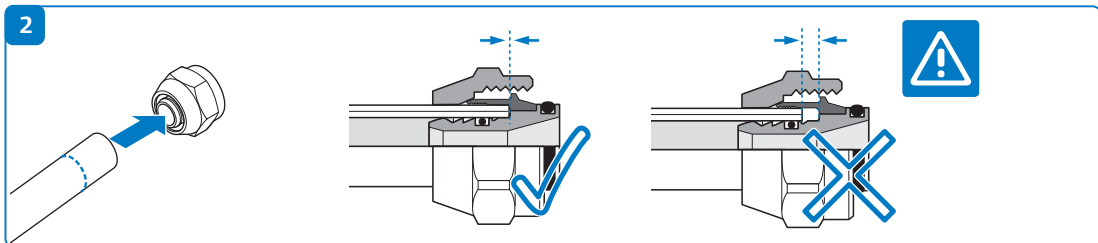

16 – 32 mm

