

Uponor Uni Pipe PLUS / MLC 1* – 110 mm

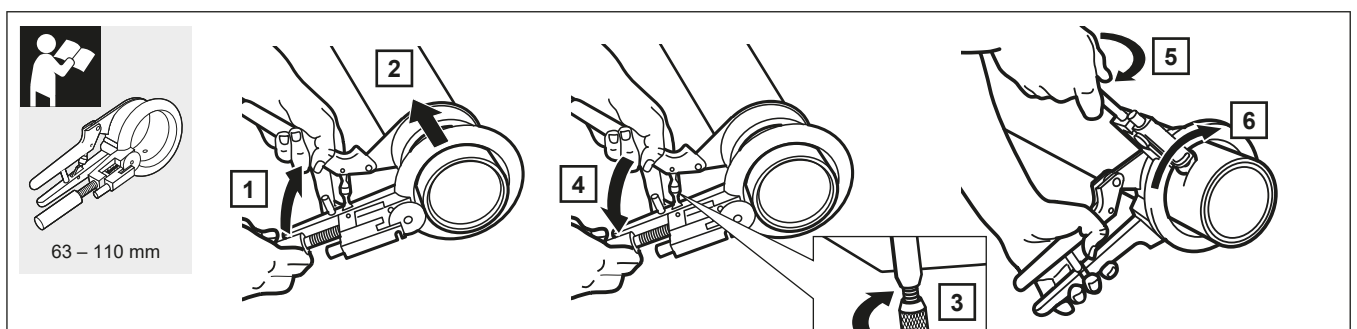

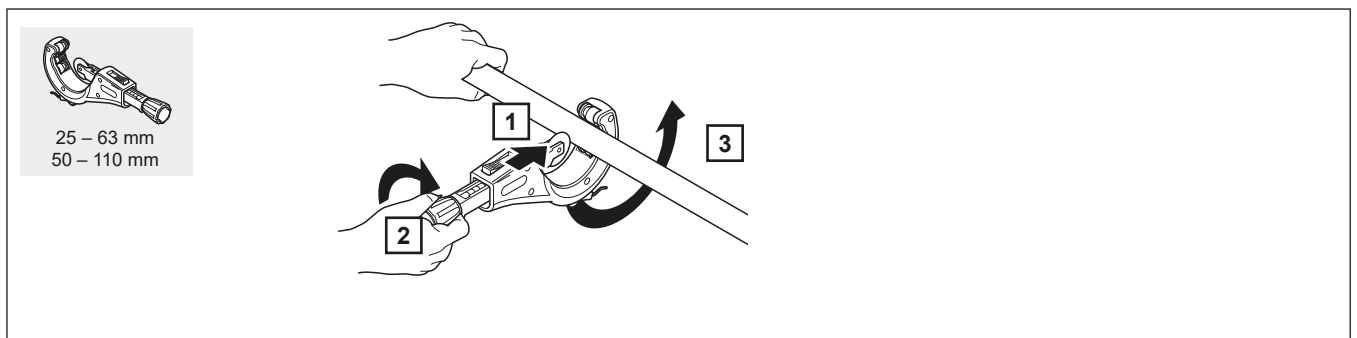
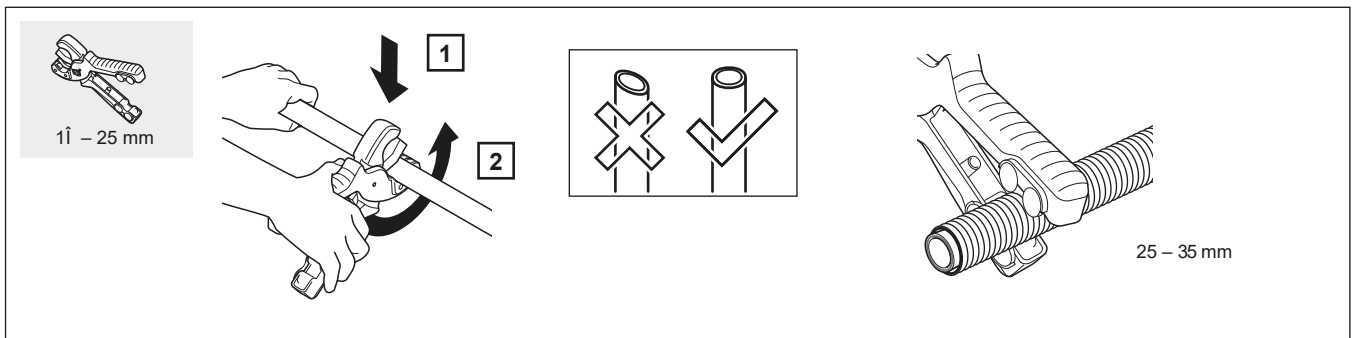
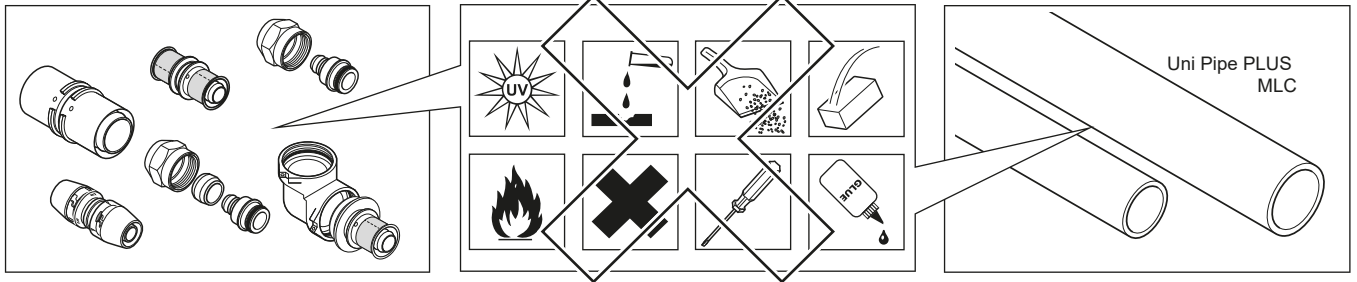

d_a [mm]	R_{min} [mm]
14	70
16	80
18	90
20	100
25	125
32	160

14 – 32 mm

d_a [mm]	R_{min} [mm]
14	56
16	64
18	72
20	80
25	100
32	128

14 – 25 mm

d_a [mm]	R_{min} [mm]
14	56
16	64
18	72
20	80
25	100

16 – 32 mm

d_a [mm]	R_{min} [mm]
16	46
18	52
20	80
25	83
32	111

$$\Delta l \text{ [mm]} = \Delta\vartheta \text{ [K]} \cdot 0,025 \frac{\text{mm}}{\text{m}\cdot\text{K}} \cdot L \text{ [m]}$$

$$BS \text{ [mm]} = 30 \cdot \sqrt{d_a \text{ [mm]} \cdot \Delta l \text{ [mm]}}$$

Dim. [mm]	L_{max} [m]
14 × 2,0	1,20 -
16 × 2,0	1,20 1,60
20 × 2,25	1,30 1,60
25 × 2,5	1,50 1,80
32 × 3,0	1,60 1,80
40 × 4,0	- 2,00
50 × 4,5	- 2,00
63 × 6,0	- 2,20
75 × 7,5	- 2,40
90 × 8,5	- 2,40
110 × 10,0	- 2,40



optional

16 – 32 mm

S-Press PLUS
S-Press PLUS PPSU

14 – 25 mm

16 – 32 mm

RTM

40 – 110 mm



16 – 25 mm

RTM

25 mm

16 mm











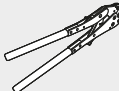
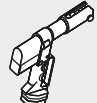



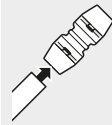



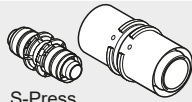

20 mm

32 mm

RTM

STOP

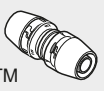

		UP110 UP75 	UP75 EL 	Mini2 Mini 			
		UPP1 	UPP1 				
 S-Press PLUS	16 – 20	16 – 32	–	–	16 – 32	–	–
 S-Press PLUS PPSU	16 – 20	16 – 32	–	–	16 – 32	–	–
 S-Press	1̂	1̂	40 – 50	63 – 75	16	–	–
 S-Press PPSU	–	–	40 – 50	63 – 75	–	–	–
	–	 16-32	 40 – 50	 63 – 110	 16 – 20	–	–
	–	–	–	–	–	16 – 25	–
 RTM	–	–	–	–	–	–	16 – 32

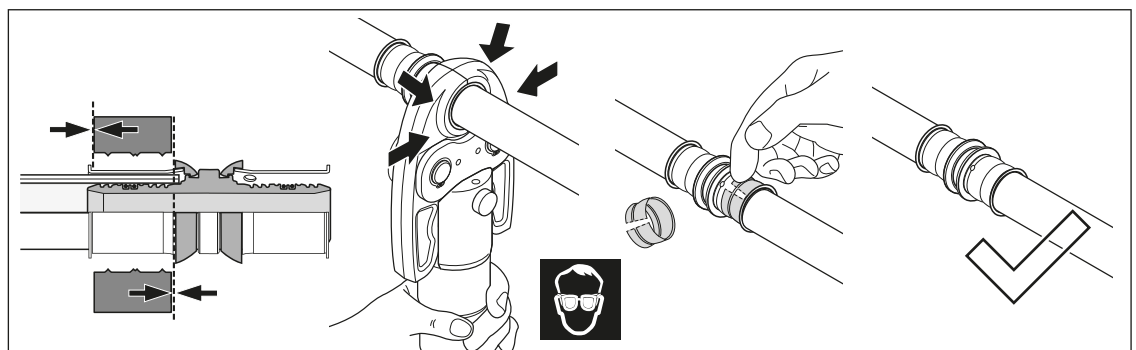
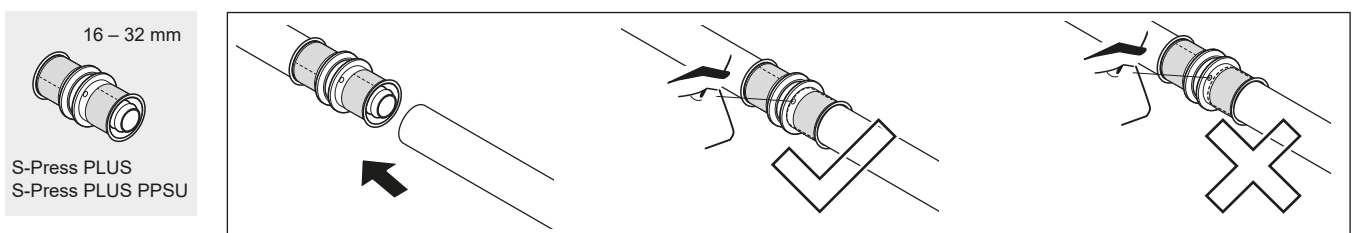

40 – 50 mm

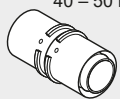

S-Press
S-Press PPSU

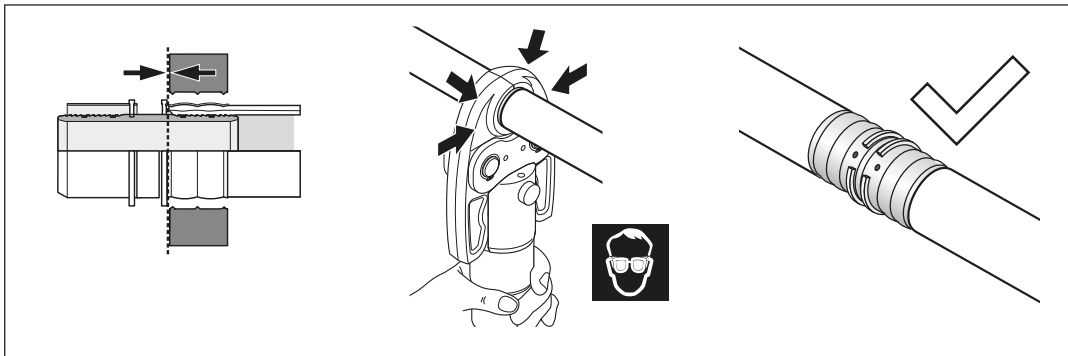
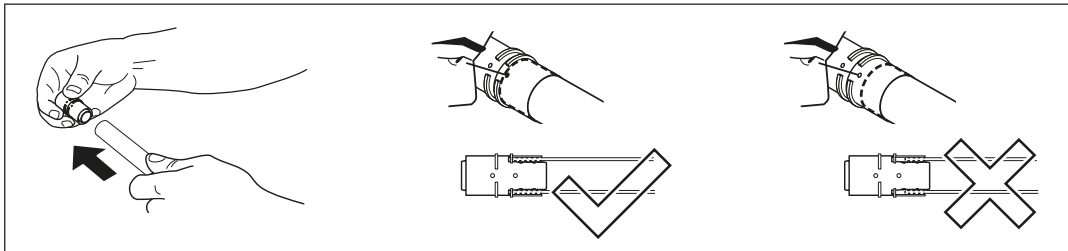

63 – 75 mm

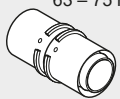

S-Press PPSU

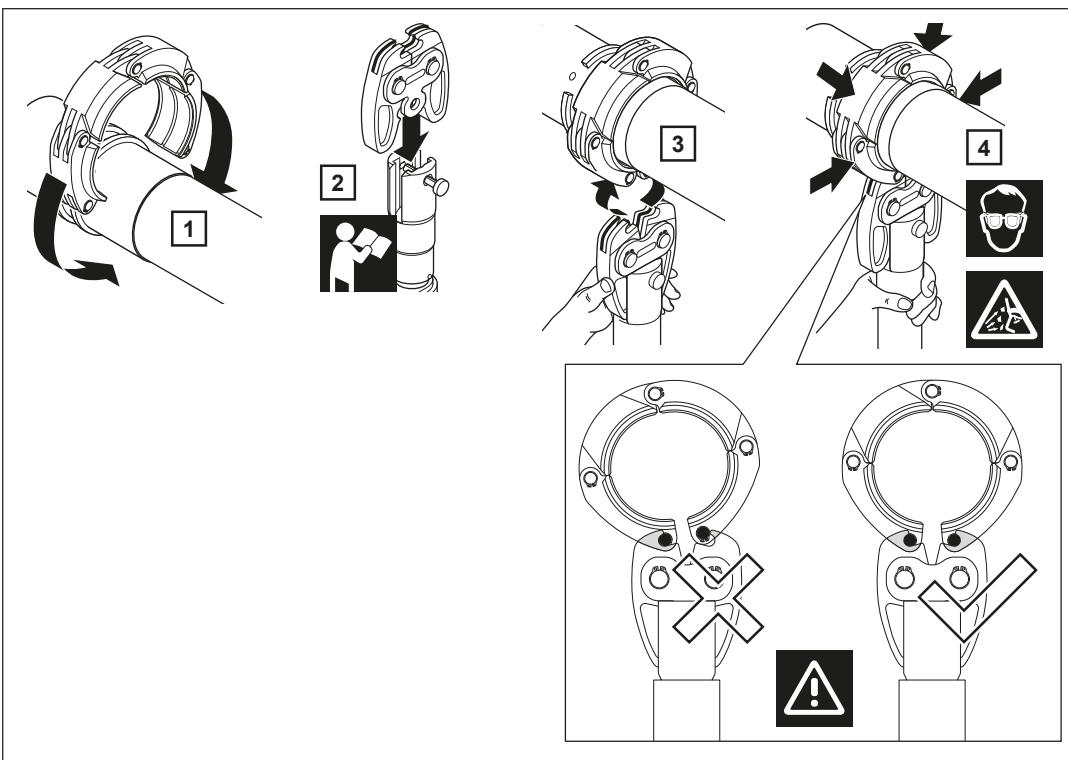
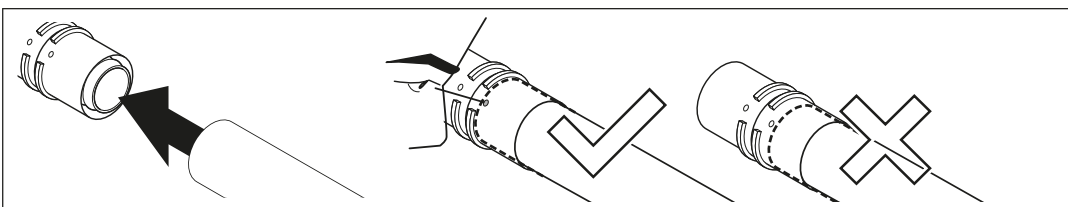

63 – 110 mm

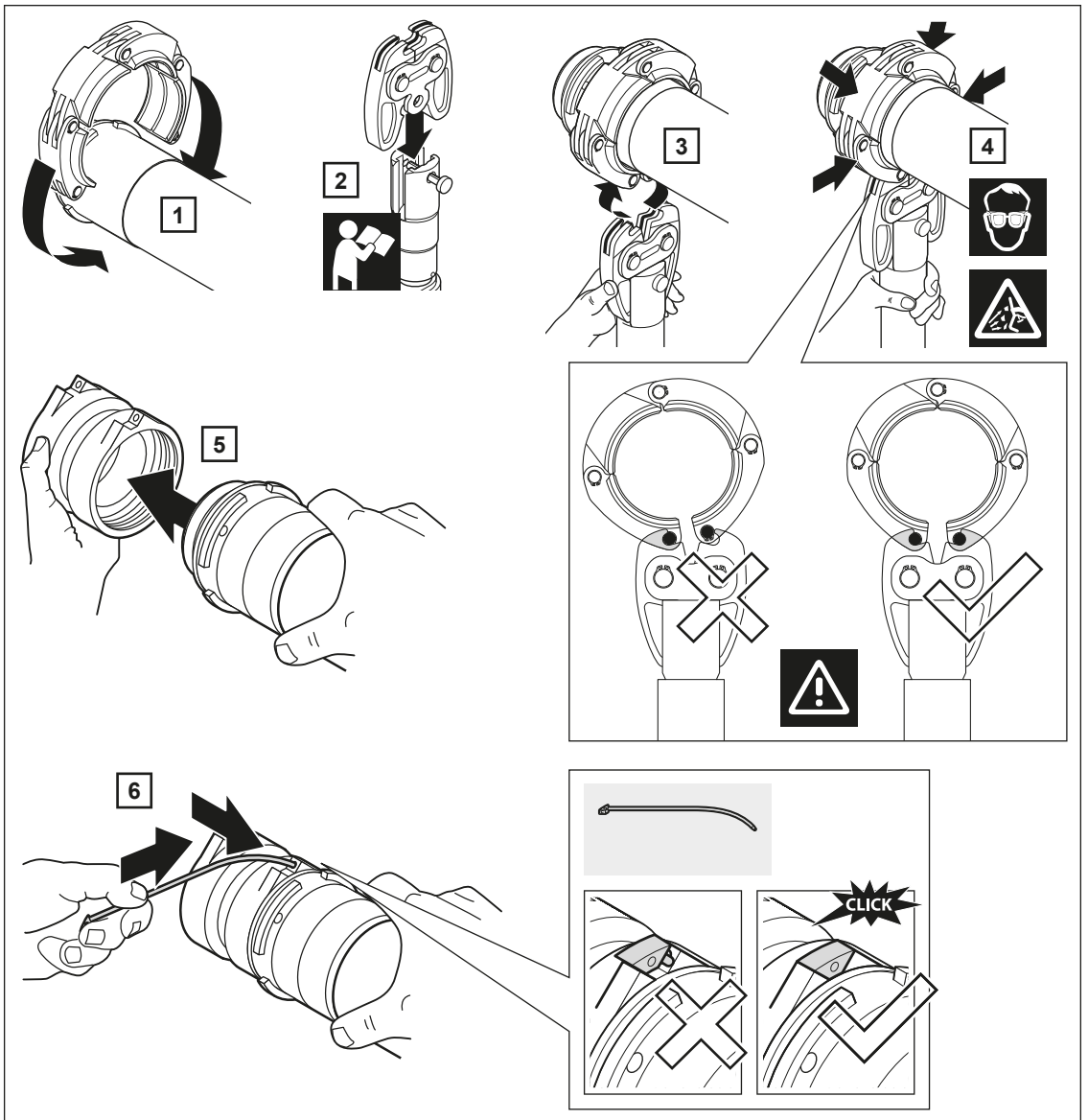
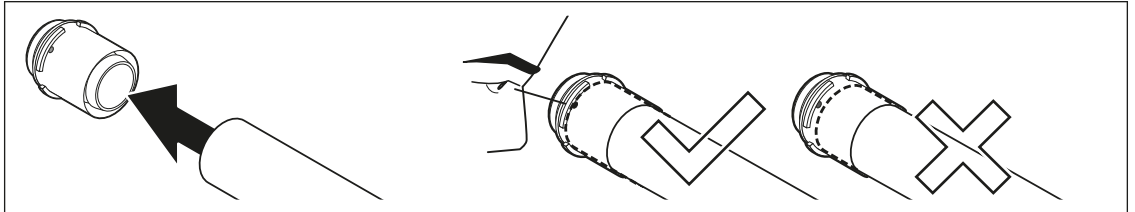
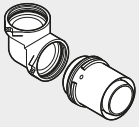



1

Fitting Dim.	X [mm]	Fitting Dim.	X [mm]	Fitting Dim. [mm]	X [mm]	Fitting Dim.	X [mm]
14 – 1/2"	8	14 – 3/4"	10	NL 14 – 15	8	16 – M 22	9
16 – 1/2"	8	16 – 3/4"	10	NL 16 – 15	8	16 – M 24	9
20 – 1/2"	10	20 – 3/4"	10	NL 20 – 22	10	16 – 1/2"	9
		25 – 3/4"	11	NL 25 – 22	14		

2

3

4



