



Uponor

Uponor Renovis technical guide

HEATING AND COOLING

Fast, dry and low temperature system for renovation

System description

Radiant heating is the most energy efficient way of creating a comfortable environment in any home. The benefits of a radiant system are many and thanks to Uponor's Renovis system it is now much easier and quicker to install. Radiant comfort is no longer exclusive to new build properties, home owners who wish to renovate can now enjoy its many benefits as well.

The main component of the Renovis system is the 15 mm gypsum panel board that encapsulates 9.9 mm PE-Xa pipes. Each panel has a flow and return tail that can be easily connected into a typical heating pipework arrangement.

The embedded pipe contained within the gypsum panel simplifies the installation of a wall or ceiling sys-

tem and ensures the optimum heating or cooling output can be achieved. Furthermore the Uponor Renovis system works perfectly with low temperature renewable energy sources such as ground and air source heat pumps – energy efficiency in any property is now possible thanks to the Renovis panel.

Benefits

- Installation on existing wall/ceiling surfaces
- Typical dry construction installation method (CD 27/60)
- No additional plasterboard layer required
- Fast installation time: 3 rooms/day
- Integration of lighting, ventilation or electrical plugs possible
- High quality Uponor PE-Xa pipes 9.9 x 1.1 mm
- Low heating supply temperatures, as low as 35°C can be used
- Mould prevention: temperature increase (up to 3°C) in wall/ceiling construction
- Individual zone control
- Heating output up to 120 W/m² (wall), 60 W/m² (ceiling)
- Cooling option (energy efficient radiant cooling possible)



System components

Uponor Renovis includes high-quality and optimally-matched system components. The system is completed once it is connected to a distribution system and its control components have been set accordingly.

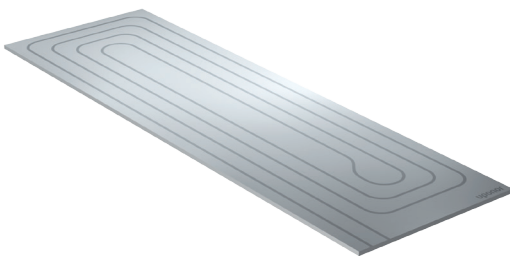

Uponor Renovis panel with embedded PE-Xa pipes



Uponor PE-Xa pipe with Q&E fitting

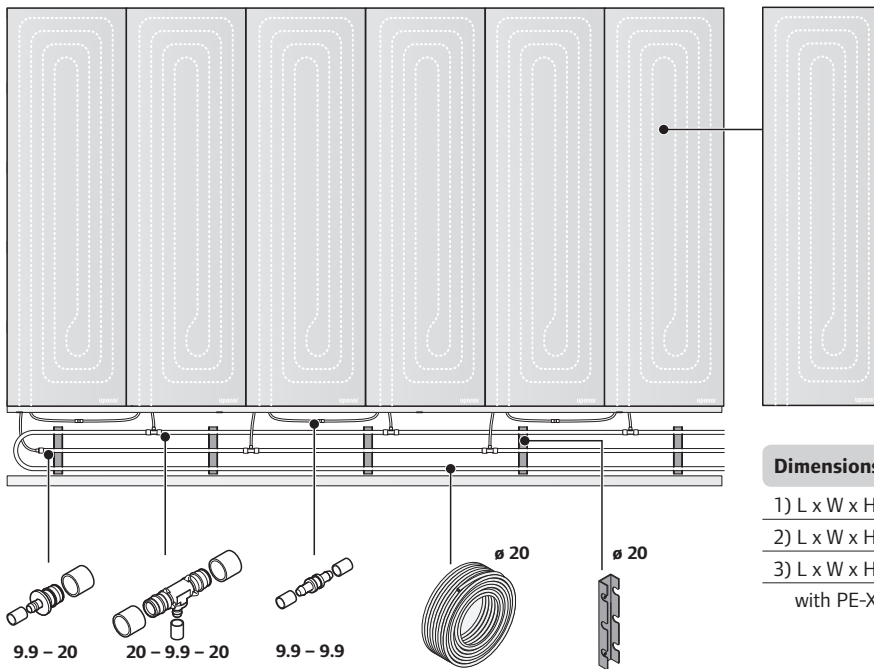

Dimensions

1) L x W x H = 2000 x 625 x 15 mm

2) L x W x H = 1200 x 625 x 15 mm

3) L x W x H = 800 x 625 x 15 mm

with PE-Xa pipe 9.9 x 1.1 mm

Application

General

When designing heating or cooling systems all respective laws, regulations and standards (see appendix) have to be considered. All relevant activities in the renovation building process have to be coordinated between involved trades:

Planning: energy consultant/architect and engineer

Involved trades: installer, plasterer or carpenter

Design aspects

When providing an energy efficient renovation, the consideration of several technical aspects is necessary:

- Building condition and physics of existing building structure and envelope (windows, outer wall insulation, insulation of roof construction and foundation)
- Condition of existing electrical and plumbing installations
- Condition of heating distributing- and connecting installations
- Condition of existing heat source: efficiency, annual operation costs

Meeting customer needs and expectations:

- Which room or building sections needs to be renovated
- Requested level of comfort: equal temperature profile in all rooms
- Free and modern styling of rooms – no radiators occupying floor or wall space
- Low temperature heating as a pre-condition for an energy efficient and cost saving renovation

With ever increasing energy costs the correct selection of heat source and emitter has never been more critical. That is where a Renovis system can help by providing sufficient heat output from water temperatures as low as 35°C. The perfect partner for renewable energy sources such as heat pumps.

Uponor Renovis solves typical renovation problems

Before the installation of an Uponor Renovis system, the condition of the existing heat source, plumbing, electrics and controls should be checked.

Common problems with a radiant renovation are easily overcome when using Uponor Renovis:

- Uponor Renovis can be mounted on existing wall/ceiling surfaces, even if they are in a bad condition (e.g. damaged plaster work or uneven ceiling construction)
- Total renovation, partial renovation or if required, the renovation can be scheduled step-by-step
- Ceiling or wall insulation can be easily integrated with the system
- Uponor Renovis can be mounted in a very short period time (3 rooms installed/day), disruption can be kept to a minimum
- No need to remove existing flooring, valuable floors can now be left in situ
- Spot lights can be directly integrated in the middle area of the Renovis panel

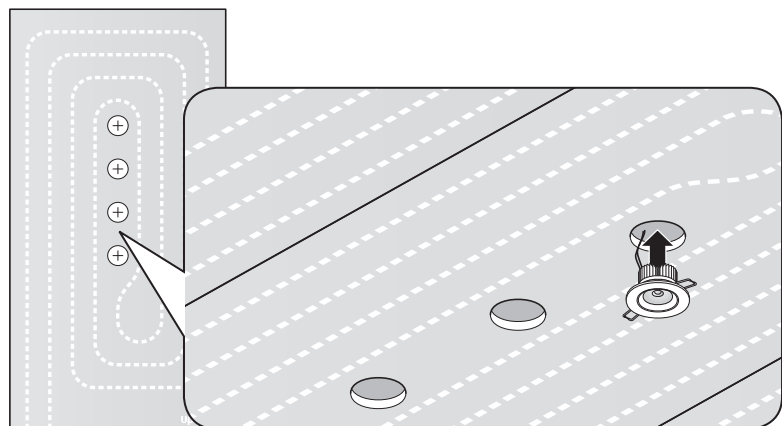

Placement of spot lights in Uponor Renovis panel

Planning

Subconstruction

The mounting frame can be made of either wood or metal. The typical rules and standards on dry wall/ceiling construction specifications have to be considered.

The construction depth depends on the design requirements, the minimum depth of the complete system is 50 mm.

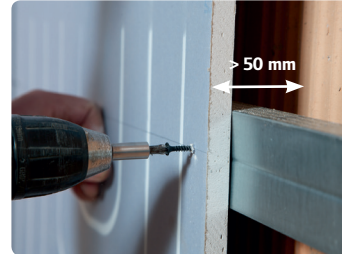

Example: Subconstruction with metal profiles CD 27/60

Dew point in external walls

Building parts affected by outdoor conditions must be protected against water condensation. This must be considered and calculated in the design phase of the renovation. Typically new or additional insulation will be added to the

external walls during the renovation of a building.

Radiant heating systems placed in renovated rooms increase the temperature of the building structure (wall/ceiling) by $> 3^{\circ}\text{C}$. This raises

the dew point temperature within the building structure and prevents water condensation and mold generation occurring at the edges and corners of the walls and ceilings.

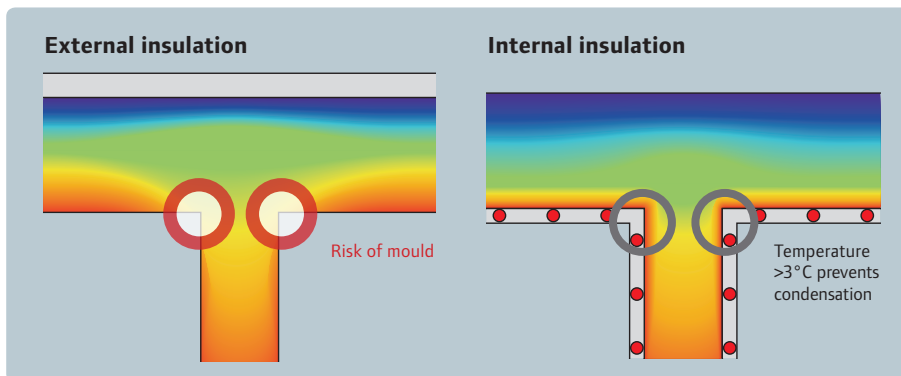

Radiant heating systems prevent condensation by increasing the temperature of the building structure (wall/ceiling) by $> 3^{\circ}\text{C}$. The wall heating system (shown in red) ensures a temperature difference of $> 3^{\circ}\text{C}$ compared to the outer wall.

Uponor Renovis on an external wall

When designing a wall heating system that is to be placed on an external wall it is very important to know the physical condition of the existing wall and the properties of the thermal insulation. When the thermal insulation is placed on the outside wall, then the Uponor Renovis system can be used with confidence. It is always recommended that the dew point is calculated for the new wall construction.

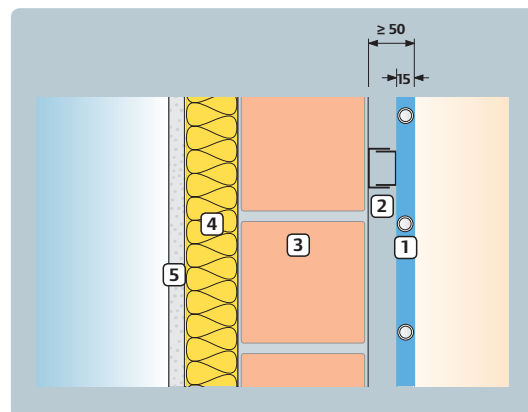

Uponor Renovis on external wall with outer insulation

- 1 Uponor Renovis panel with Uponor PE-Xa pipe 9.9x1.1 mm
- 2 CD profile (27/60)
- 3 Brick wall
- 4 Outer insulation
- 5 Outer plaster

Uponor Renovis on inner walls or ceilings

Uponor Renovis can be mounted without limitations on inner walls or ceilings. When thermal insulation is required, then the material must confirm to European standards (EN 13163, EN 13164, ...) and must be

certified accordingly. The insulation requirements and thickness (requirements acc ISO 11855/EN 1264) have to be determined in the design phase by an energy consultant or planner.

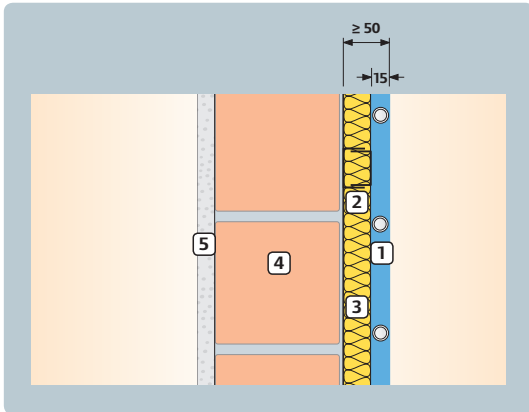

Uponor Renovis on insulated inner wall

- 1 Uponor Renovis panel with Uponor PE-Xa pipe 9.9 x 1.1 mm
- 2 CD profile (27/60)
- 3 Internal insulation
- 4 Brick wall
- 5 Plaster

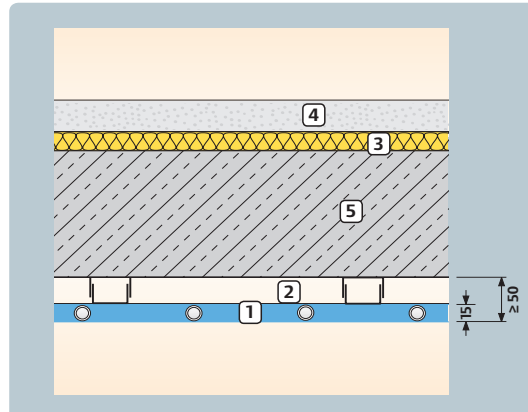

Uponor Renovis under ceiling

- 1 Uponor Renovis panel with Uponor PE-Xa pipe 9.9 x 1.1 mm
- 2 CD profile (27/60)
- 3 Internal insulation
- 4 Screed
- 5 Ceiling

Finish/filling/covering of walls and ceilings

Uponor Renovis panels are profiled on both the length sides so that a filling compound can be easily applied and smoothed over. Panels can be painted or wallpapered directly onto, or if preferred a thin layer of finishing plaster can be applied to the surface.

The finish of gypsum surfaces including Uponor Renovis have to be done in accordance with dry construction guidelines.

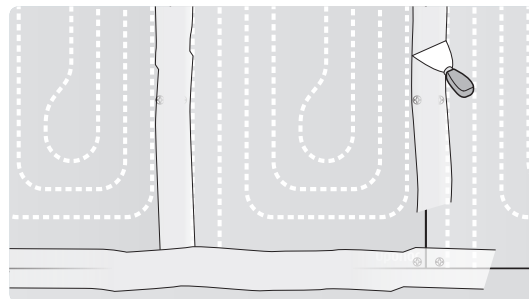

Finish of Uponor Renovis with Knauf UNIFLOTT

Find covered pipes, drill-free zones

Pipes embedded within the Renovis panel are not visible. Before drilling holes or screws into ceilings or walls it is necessary to check the pipe position. Prior to doing this you must ensure that the heating system has been switched on so that the thermo foil can detect the heat signature from the warm water circulating through the pipes.

Areas requiring fixings for mounting TV brackets, pictures, screens etc, must be considered at the design stage of the panel layout. These areas can be left free by fitting blind gypsum panel boards that do not have any embedded pipework.

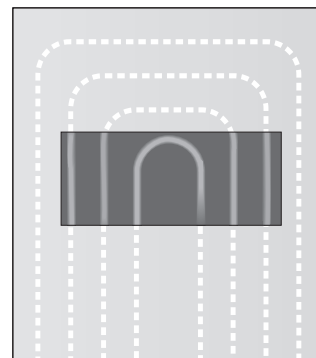

Thermo foil for heating pipe detection

Technical concepts of connecting pipes

Uponor Renovis Panels consist of 15 mm gypsum board with integrated PE-Xa pipes 9.9 x 1.1 mm. The panels must always be connected by flow/return-principle using Uponor Q&E fittings.

Wall heating connection

Often in renovation cases the existing radiator connecting points can be used for the application of radiant heating panels. A check on the condition of these pipes is very important prior to using them.

Depending on the supply temperature the water temperature required within the Renovis system can be controlled by:

1. Single room connection (thermostatic valve + return valve) controlled by room thermostat
2. Pump group (Uponor Push-12) controlled by room thermostat



Example: Connection of Uponor Renovis panels mounted on the wall. Single room control by room thermostat.

Ceiling heating connection

The most suitable connection for a ceiling is a manifold. It can be placed inside the ceiling construction or on the wall (e.g. in a hall). The connecting 20 mm PE-Xa pipes are fixed in the rails (system component) and connected by flow/return-principle with Q&E fittings.

When using a Uponor manifold, the temperature control of renovated rooms can be solved by using the wireless Uponor DEM control system. Wireless sensors can be placed within each renovated room allowing for independent air temperature control. This also has the benefit of removing the need for any wiring within the walls.

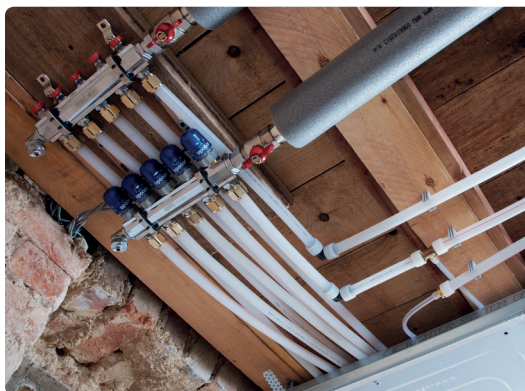

Example: Connection of Uponor Renovis panels mounted on the ceiling with Uponor manifold. Individual room control by thermal actuator and room sensor.

Maximum amount of panels per loop

A maximum of 3 Uponor Renovis panels can be connected in series. The flow and return connection principle must be used when connecting the 20x2 mm PE-Xa pipes.

Renovis with:	Active area (max. loop size)	Heating output \dot{Q} [kW]
Push-12 ($\vartheta_{V/R} = 50/40$ °C)	1 loop as flow-return-connection 20 x 2 with 4 x 3 panels (15 m ²)	1.8
Manifold ($\vartheta_{V/R} = 50/40$ °C)	1 loop as flow-return-connection 20 x 2 with 8 x 3 panels (30 m ²)	3.8
Manifold ($\vartheta_{V/R} = 50/45$ °C)	1 loop as flow-return-connection 20 x 2 with 8 x 2 panels (20 m ²)	2.5

Control concepts

Uponor control components for control of supply and individual room temperature allow energy-efficient

and cost-saving operation of radiant heating systems while ensuring maximum living comfort.

Total renovation

In total renovation (e.g. renovation of a complete house) the Uponor DEM control is recommended for use with the Uponor manifold. Wireless temperature sensors measure the operative room temperatures within each zone. Furthermore the unique auto-balancing function ensures the optimal amount of energy is used whilst improving performance.

As with any radiant heating system the type of control required depends upon the supply temperature from the heat source. Uponor Renovis panel can be operated up to a maximum of 50°C.

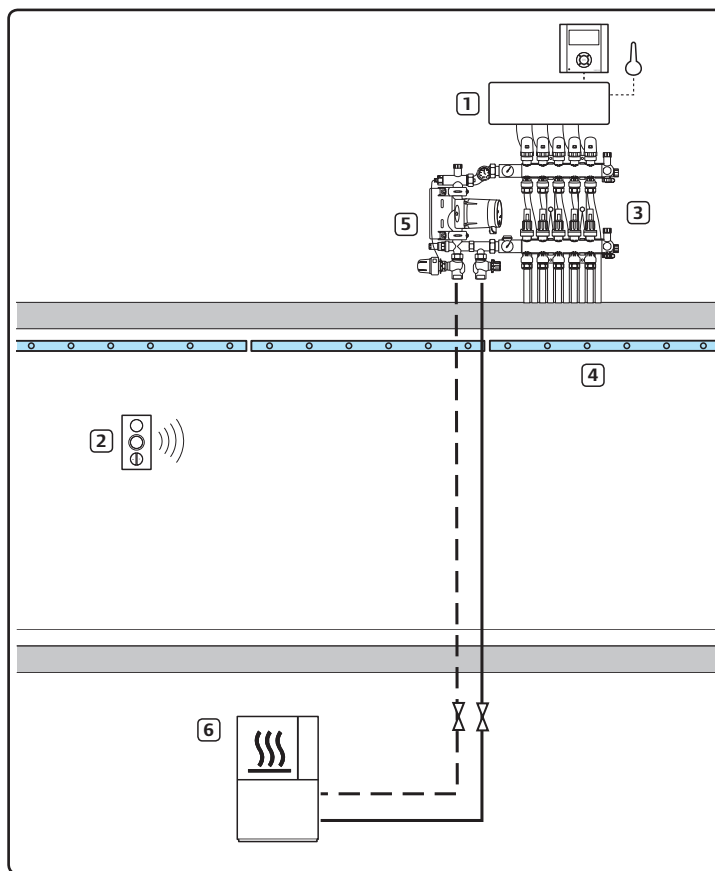

- 1 Control unit
- 2 Room sensor
- 3 Manifold
- 4 Renovis panels
- 5 Pump group
- 6 Heat source

Example: supply temperature control with Uponor pump group

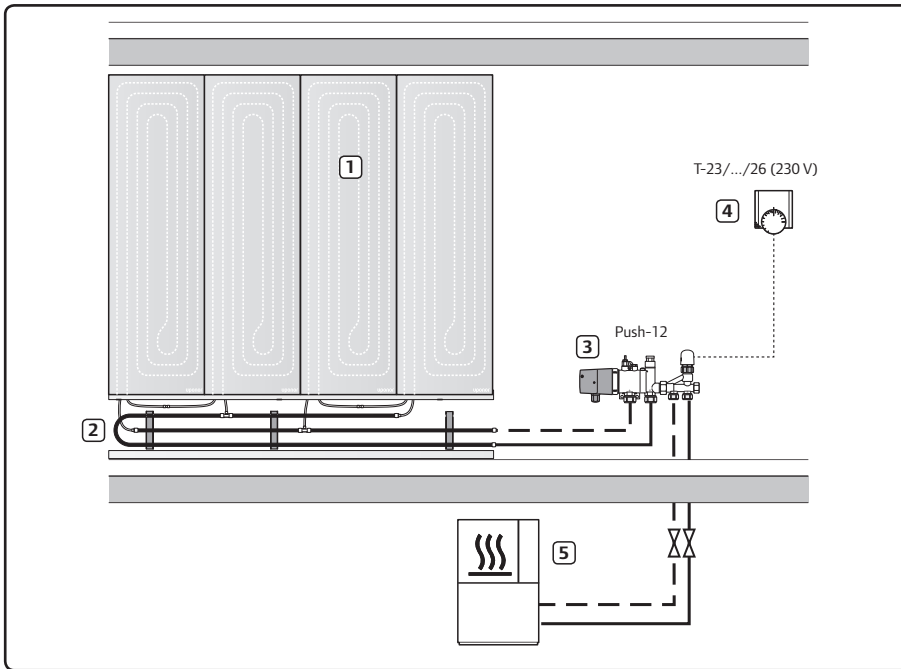

- 1 Renovis panels
- 2 Flow-return-connection with Q&E fittings
- 3 Pump group
- 4 Room sensor
- 5 Heat source

Example: supply temperature < 70°C. Water mixing by Uponor Pump group Push-12 necessary

Partial renovation

For a partial renovation (e.g. 1 room or bath room renovation) the control unit consists only of single room thermostat.

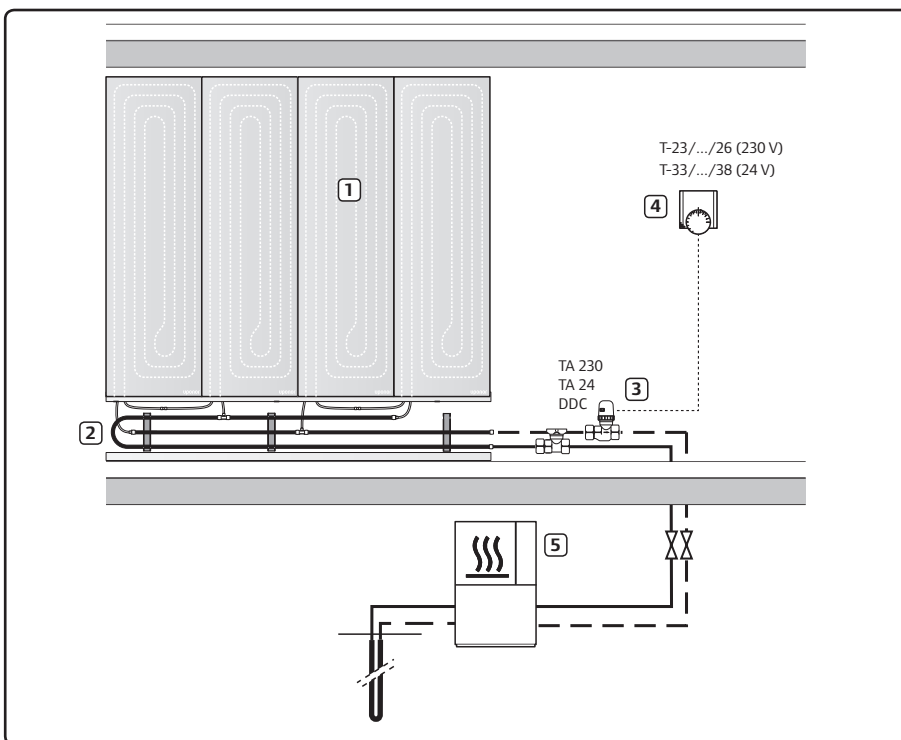

- 1 Renovis panels
- 2 Flow-return-connection with Q&E fittings
- 3 Single valves with thermostat head
- 4 Room sensor
- 5 Heat source, e.g. heat pump

Example: supply temperature < 50°C

Design and calculation

Temperatures

Surface temperature

Special attention must be paid to the surface temperature, taking into account medical and physiological considerations. The difference between the mean surface temperature of the wall/ceiling and the design room temperature give an indication of the heating output that can be achieved.

Max. surface temperatures acc ISO 11855/ EN 1264:

40°C on the wall; 29°C at the ceiling

Room temperature, operative (perceived) temperature and mean supply temperature

Radiant heating system like Uponor Renovis can be operated at low supply temperatures (low as 35°C, additional use of heat pumps affords the best possible seasonal performance factor (SPF)).

High temperature fluctuations might result in expansion noises.

By using radiant heating, the room air temperature can be lowered by 2°C with the same operative temperature and sensation of thermal comfort. This leads to energy savings of 12%, which in turn leads to significant cost savings.

Thermal heating (cooling) performance

Placing of Uponor Renovis panels

Uponor Renovis panels can be placed on wall or/and ceiling. The performance (heating output) depends on this placing (consider Uponor Renovis heating output diagrams later in this chapter).

Flow/return-connecting-pipes

The connecting pipes for Uponor

Renovis can be placed inside the dry construction of the system. They are not insulated and emit heat into the room.

Thermal resistance of wall/ceiling insulation

According to ISO 11855/EN 1264 the thermal insulation must be designed as follows:

Minimal thermal resistance R_{λ} of the wall/ceiling insulation according to ISO 11855/ EN 1264:

$R_{\lambda} = 0,75 \text{ m}^2\text{K/W}$ against neighbouring heated rooms

$R_{\lambda} = 1,25 \text{ m}^2\text{K/W}$ against not heated rooms or ground-adjacent rooms

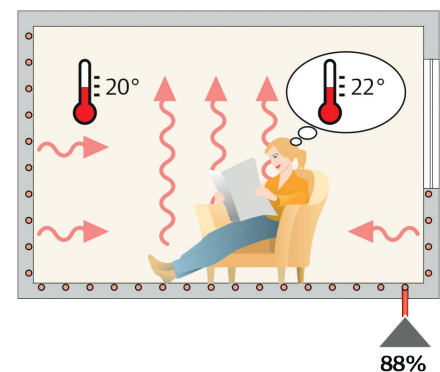
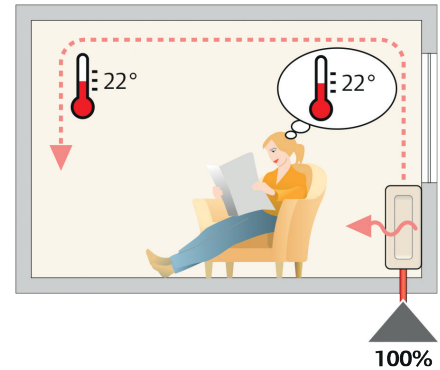

Rough calculation of Renovis panels

Using the table you can find the range of heating output for either a wall or ceiling:

Thermal output of Uponor Renovis panels

Thermal output q [W/m ²]	Supply temperature ϑ_v [°C]			
	55	50	45	40
Wall q_w	128	108	90	70
Ceiling q_b	–	–	79	60

The following method gives you an approximate estimation of the amount of Renovis panels for either a wall or ceiling.

Specifications:

Room size	= 25 m ²
Heat demand per room q_R	= 1500 W
Room temperature ϑ_i	= 20 °C
Supply temperature ϑ_v	= 50 °C ($\Delta\vartheta = 10$ K)
Dimension Renovis panel	= 0.625 x 2 m ²

Result:

Specific heating output, wall q_w	= 108 W/m ² (see table)
Required heating area A_H	= 1500/108 = 14 m ²
Quantity of Renovis panels	= 14 / (0.625 x 2) = 11.2 pcs

Material list:

- 1 x Pack (15 m²) Uponor Renovis panels 2.0 m
- 1 x Pack Uponor Renovis components for 4-6 loops
- 1 x Uponor Pump Group Push-12

Example: Renovis wall heating estimated for 1 room

Diagrams heating /cooling

The following output graphs detail the heating/cooling output that can be achieved based upon a supply temperature for either a wall or ceiling application:

Design diagram Uponor Renovis **wall** heating/cooling
 ($s_{ui} = 4 \text{ mm}$ with $\lambda_{ui} = 0.3 \text{ W/mK}$)

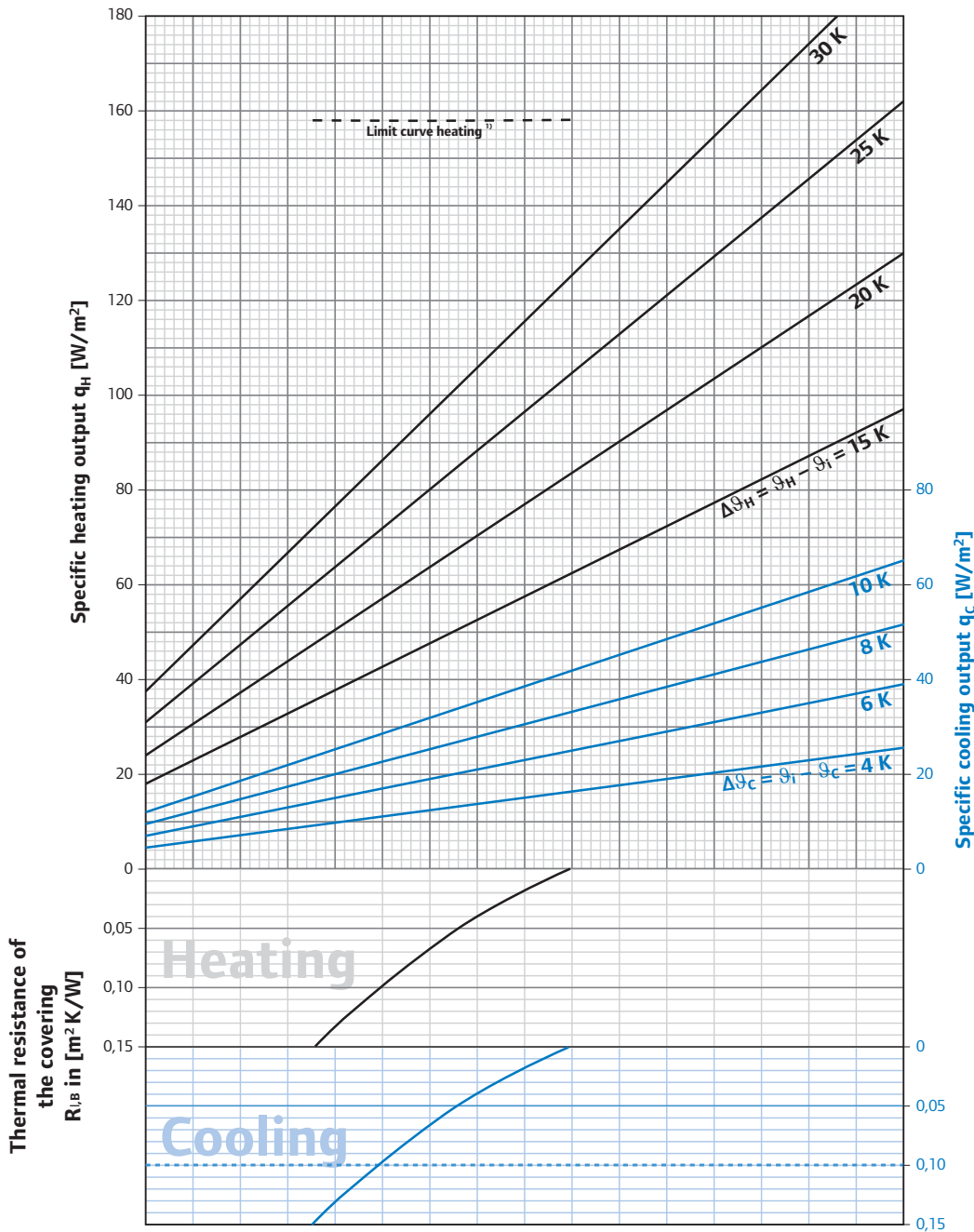

¹⁾Limit curve valid for $\vartheta_i = 20 \text{ }^\circ\text{C}$ and $\vartheta_{F,\text{max}} = 40 \text{ }^\circ\text{C}$ (physical limit temperature)

Note: The limit curves must not be exceeded. Maximum flow temperature of Uponor Renovis: $\vartheta = 50 \text{ }^\circ\text{C}$.
 By cooling the flow temperature should be adjusted using dew point temperature, a humidity sensor must be scheduled.

Design diagram Uponor Renovis **ceiling** heating/cooling

($s_u = 4$ mm with $\lambda_u = 0.3$ W/mK)

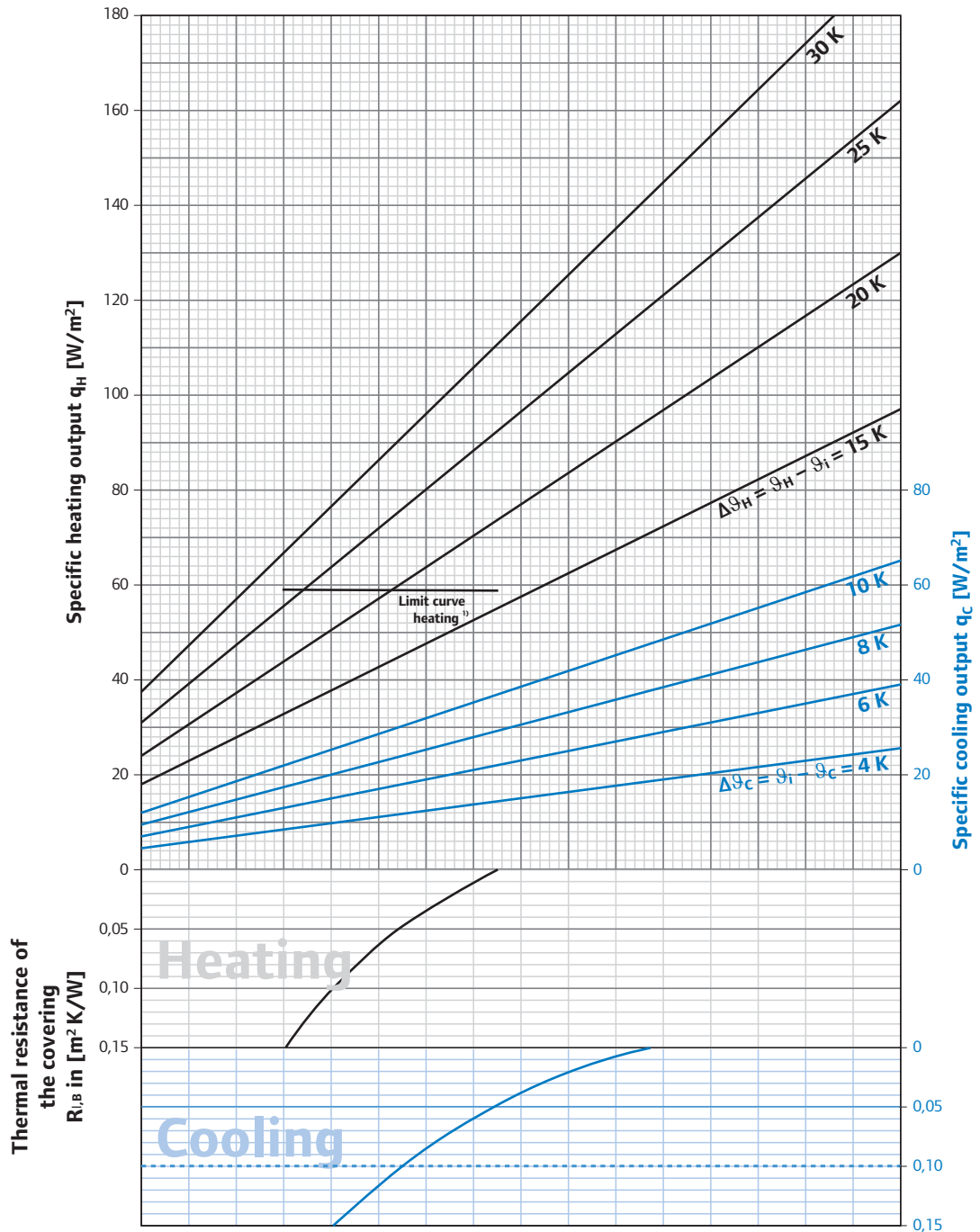

¹⁾ Limit curve valid for $\theta_r = 20$ °C and $\theta_{F,m} = 29$ °C

Note: The limit curves must not be exceeded. Maximum flow temperature of Uponor Renovis: $\theta = 50$ °C. When used for radiant cooling the flow temperature must be adjusted so as to avoid a condensation event from occurring. Uponor recommends the Uponor C-46 Climate Controller for radiant cooling applications.

Pressure losses Uponor PE-Xa pipe

The pressure losses in the Uponor PE-Xa pipes can be determined with the aid of the diagram (pipe length per panel, see page 20).

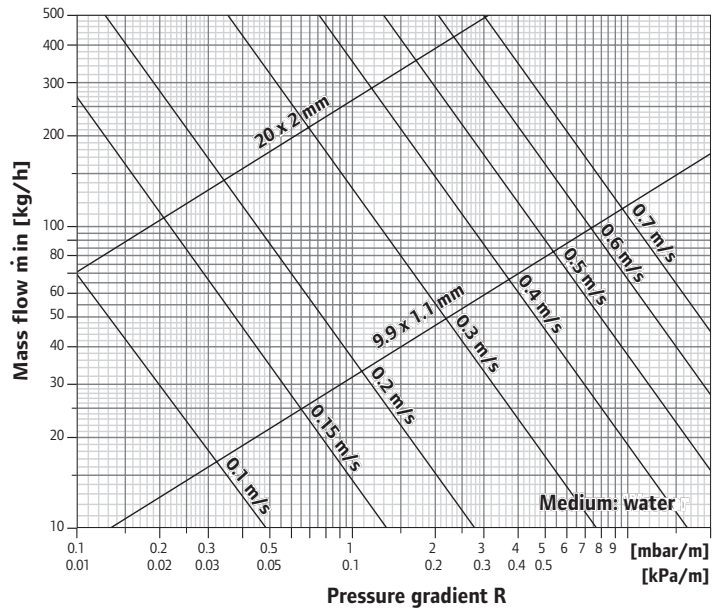

Hydraulic adjustment

The varying performance requirements and loop lengths in the various rooms and/or heating areas make it necessary to pump precisely the quantity of water through the heating/cooling loops required to

meet the heating/cooling demand at any time. Innovative intelligent control systems with DEM (Dynamic Energy Management) from Uponor achieve this by cycling the respectively required and self-adjusting

quantity of water for the loop depending on need (auto-balancing). This makes static hydraulic balancing, as required in conventional systems, unnecessary.

Static hydraulic balancing

For hydraulic balancing all heating/cooling loops on the manifold must be balanced to the least favourable loop (greatest pressure loss). This is known as "static hydraulic balancing" and is described using the following example:

Loop	Mass flow rate loop [kg/h]	Pressure loss loop [mbar]	Differential pressure at the supply valve to be restricted [mbar]
L 1	150	215	0
L 2	130	175	215 - 175 = 40
L 3	100	195	215 - 195 = 20
L 4	110	200	215 - 200 = 15
L 5	170	180	215 - 180 = 35

Manifold (example)

Manifold diagram example: HTG manifold

m_{HKS} Loop mass flow rate
(in this case: L 5 loop)

$\Delta p(dr)_{HKS}$ Differential pressure at the supply valve to be choked
(in this case: L 5 loop)

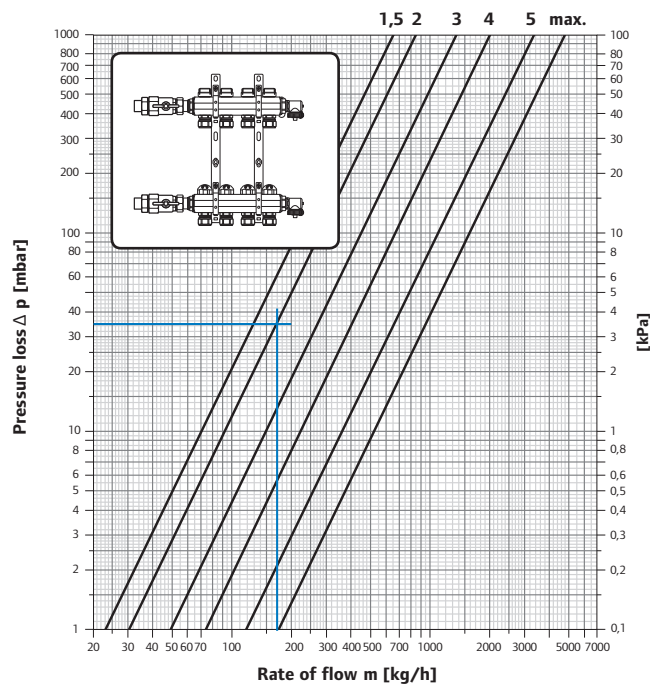

Mounting instruction

Uponor Renovis must be installed by expert installers only. Observe the following assembly instructions and additional instructions which are provided with the components and tools or which can be downloaded from www.uponor.com

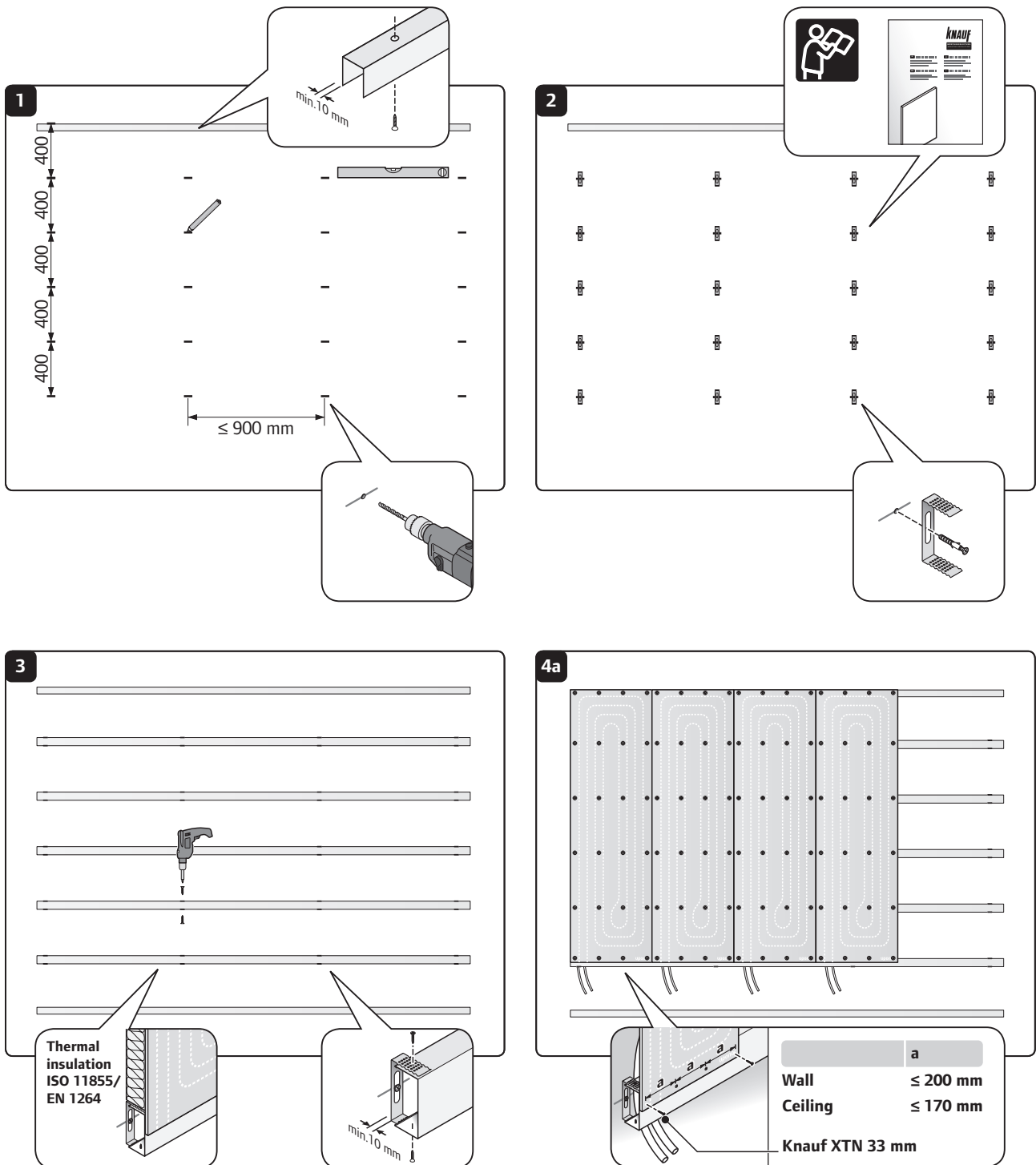

4b

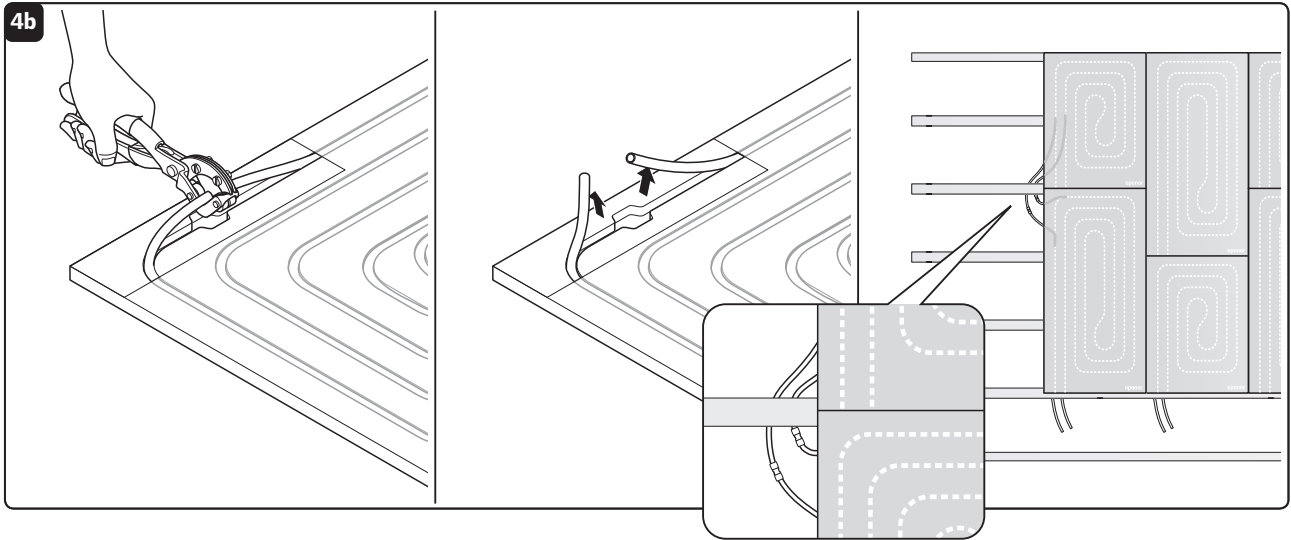

Ceiling

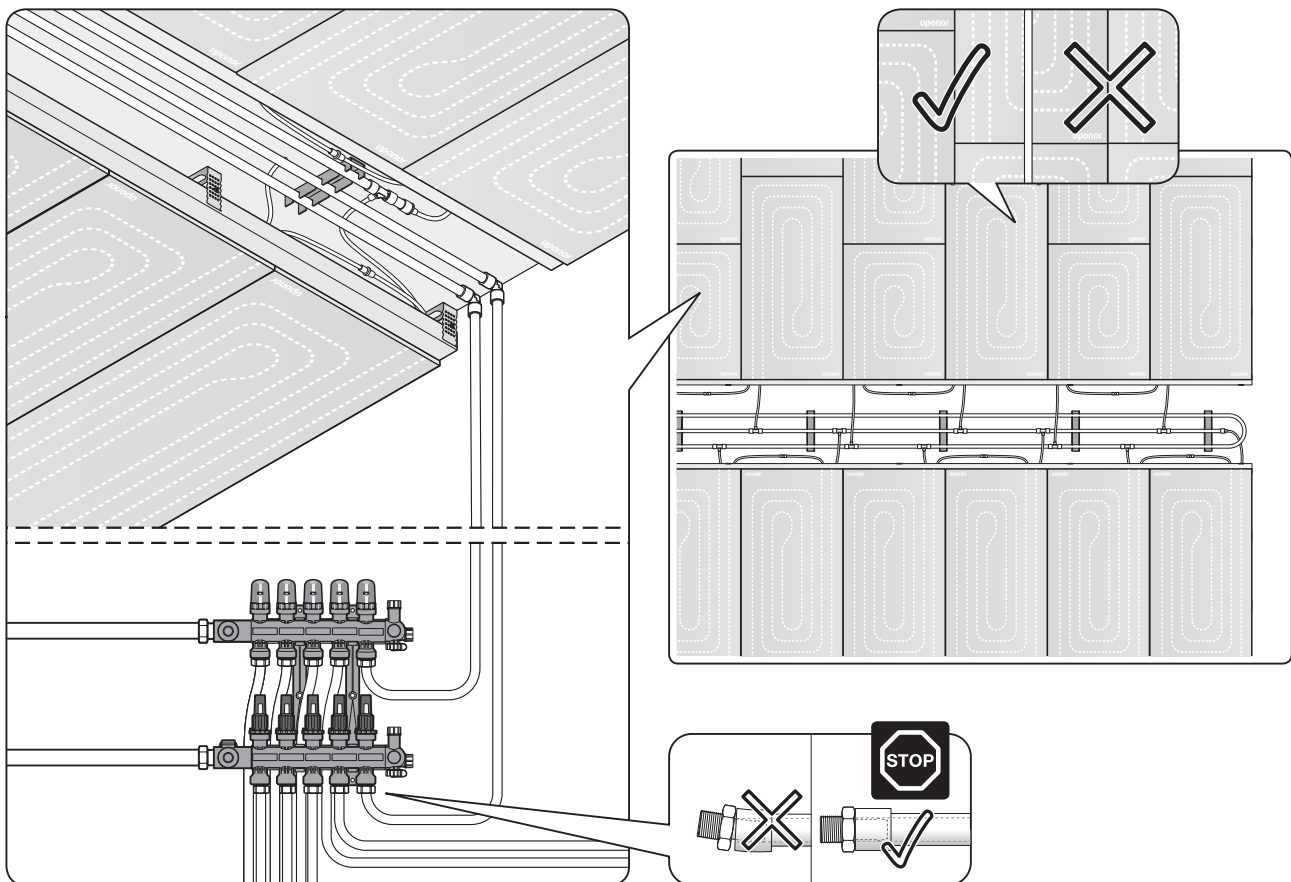

Wall

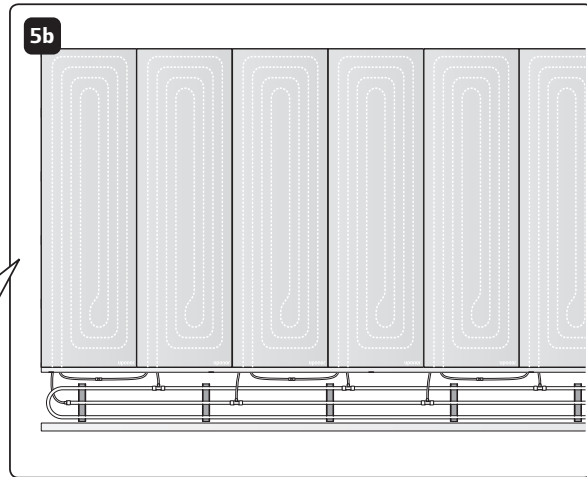
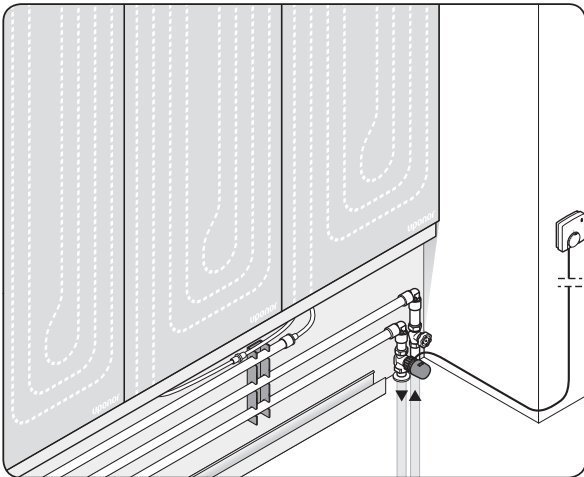

Operation

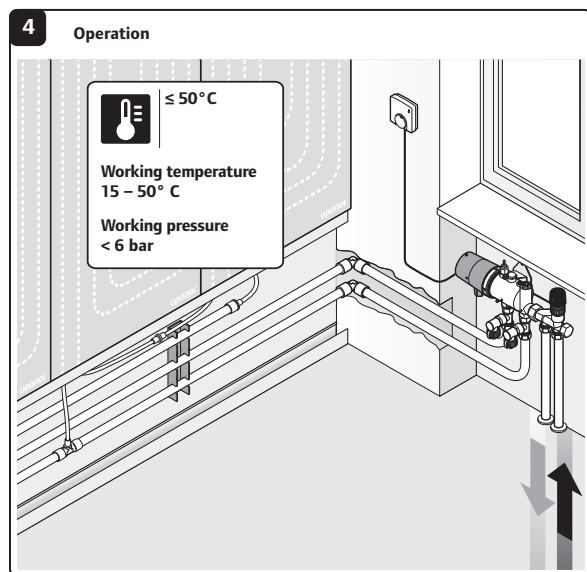
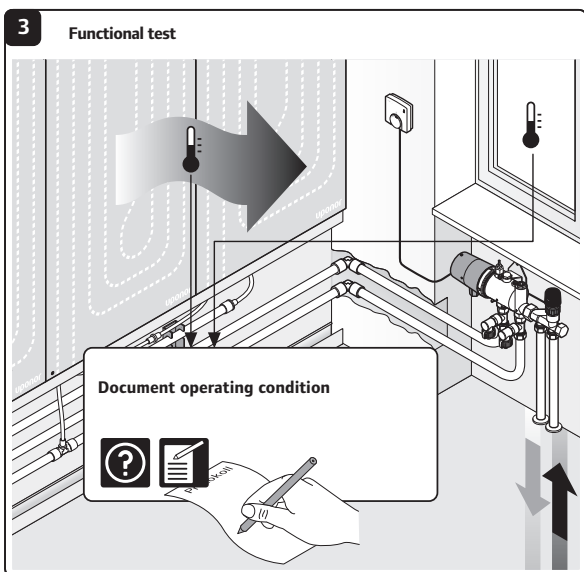
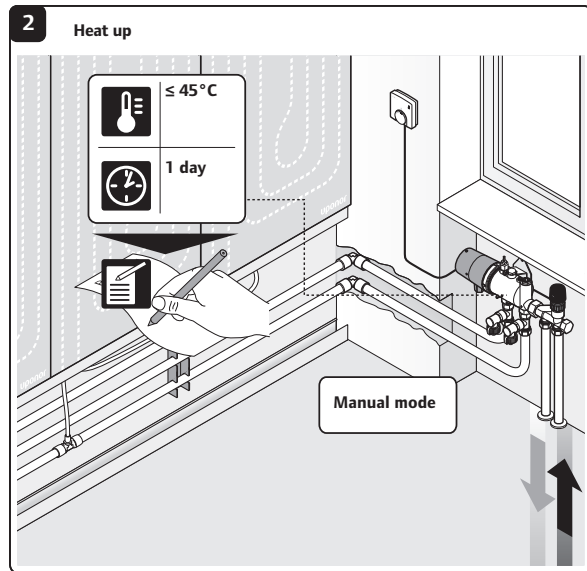
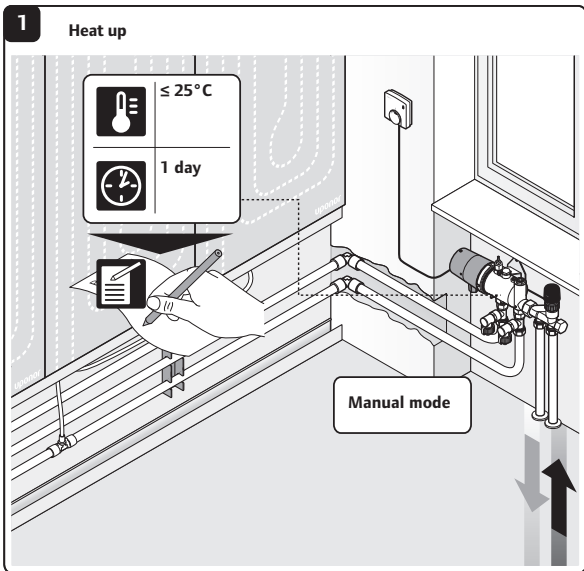

Pressure test report for Uponor Renovis

Note: Please observe the accompanying explanations and descriptions in the latest technical documentation from Uponor

Building project _____

Section _____

Test personnel _____

Requirement (in accordance with EN 1264-4) **Before applying the covering, carry out a leak test on the heating/cooling circuits with a water pressure test. The test pressure must be ≥ 4 bar and ≤ 6 bar.**

Temperature equalisation between the ambient air temperature and the temperature of water within the pipes must occur before finalising the pressure test. After this waiting period it may be necessary to re-establish the test pressure.

Any devices or fittings such as safety valves and expansion vessels that are not suitable for the pressure test must be disconnected from the installation that is being pressure tested. The installation is filled with heating water and fully vented. A visual check of the pipe joints is carried out during the test.

Start Date _____ Time _____ Test pressure _____ bar

End Date _____ Time _____ Pressure difference _____ bar (max. 0,2 bar!)

The leak test was started in the case of $\vartheta_i \geq 5$ °C no earlier than 0.5 hours and in case of $\vartheta_i = 0 - 5$ °C no earlier than 3 hours after completion of the pipe connection. Yes No

Ambient temperature during the pipe connection assembly _____ °C

On the _____ the installation identified above was heated to the design temperatures, and no leaks could be found. After cooling, it was still not possible to find leaks. Suitable measures (e.g. the use of antifreeze, temperature control of the building) should be taken if there is a risk of freezing. If antifreeze is no longer required for operation of the plant in accordance with specifications the antifreeze should be removed by emptying and flushing the installation, using at least a 3-fold water exchange.

Antifreeze was added to the water Yes No

Procedure as described above Yes No

The pressure test has been carried out in accordance with the report

Installing plumber - date/signature

Client: - date/signature

Laws, regulations, standards and guidelines

The valid laws, regulations, standards and guidelines along with the manufacturer's information, must be observed and/or applied in the design, construction, installation and commissioning of Uponor Renovis, particularly in the areas:

- Building shell/structure
- Heat insulation
- Energy-efficiency
- Fire safety
- Sound protection

The following table contains a list of the most important standards and regulatory documents.

Standards and regulatory documents	Meaning
EN 12831	Calculation standard heating load of buildings
ISO 11855	Building environment design - Design, construction and operation of radiant heating and cooling systems - Part 1: Definition, symbols, and comfort criteria
ISO 11855	Building environment design - Design, dimensioning, installation and control of embedded radiant heating and cooling systems - Part 2: Determination of the design heating and cooling capacity
ISO 11855	[...] - Part 3: Design and dimensioning
ISO 11855	[...] - Part 5: Installation
ISO 11855	[...] - Part 6: Control
EN 1264 (1-4)	Underfloor heating - systems and components
EN ISO 15875	Plastic pipework systems for hot and cold water installation - interlinked polyethylene (PE-X)
EN 12828	Safety equipment in heat generation systems
EN 13162 to EN 13171	Factory produced thermal insulation materials for buildings
EN 13831	Expansion vessels with integrated membrane

Technical data

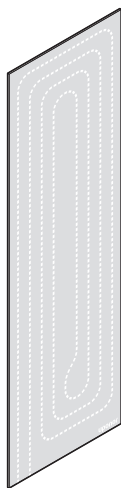

Uponor Renovis panel

Application	Wall, ceiling
Components	Gypsum board, PE-Xa pipes
Weight	12.1 kg/m ²
Weight, panel with water	12.7 kg/m ²
Pipe lengths per m ²	12.3 m/m ²
Pipe/panel (2000 x 625)	16.1 m/panel
Pipe/panel (1200 x 625)	10.1 m/panel
Pipe/panel (800 x 625)	7.1 m/panel
Water/panel (2000 x 625)	0.71 kg/panel
Water/panel (1200 x 625)	0.43 kg/panel
Water/panel (800 x 625)	0.3 kg/panel
Max. pressure	6 bar
Temperature range	15 - 50 °C
Thickness	15 mm
Material (board)	Glass fibre reinforced gypsum board
Conductivity (board)	0.3 W/mK
Application in domestic bathroom	≤ 70 % constant rel. humidity
Dimensions	2000 x 625 x 15 / 1200 x 625 x 15 /

Pipe

Material	PE-Xa, (EvalPex)
Outer diameter	9.9 x 1.1 mm
Inner diameter	7.7 mm
Space	50 mm

Uponor Corporation
www.uponor.com

Uponor

Uponor reserves the right to make changes, without prior notification, to the specification of incorporated components in line with its policy of continuous improvement and development.