

RainBlock
Smart system

uponor

EN: Installation Instructions

FI: Asennusohje

SE: Installationsanvisning

DK: Installationsvejledning



Installation window Asennusolosuhteet Installationsförhållanden Installationsbetingelser	4
Use of construction machinery in the installation phase Koneiden käyttö asennusvaiheessa Användning av entreprenadmaskiner under installationsfas Brug af entreprenørmaskiner i installationsprocessen	5
Site of installation Asennuspaikka Installationsplatsen Installationssted	6
Tools and supplies Työkalut ja tarvikkeet Verktyg och utrustning Værktøj og forsyninger	6
Product range Tuotevalikoima Sortiment Produktsortiment	7
Installation and assembly Asennus ja kokoonpano Installation och montering Installation og montage	7

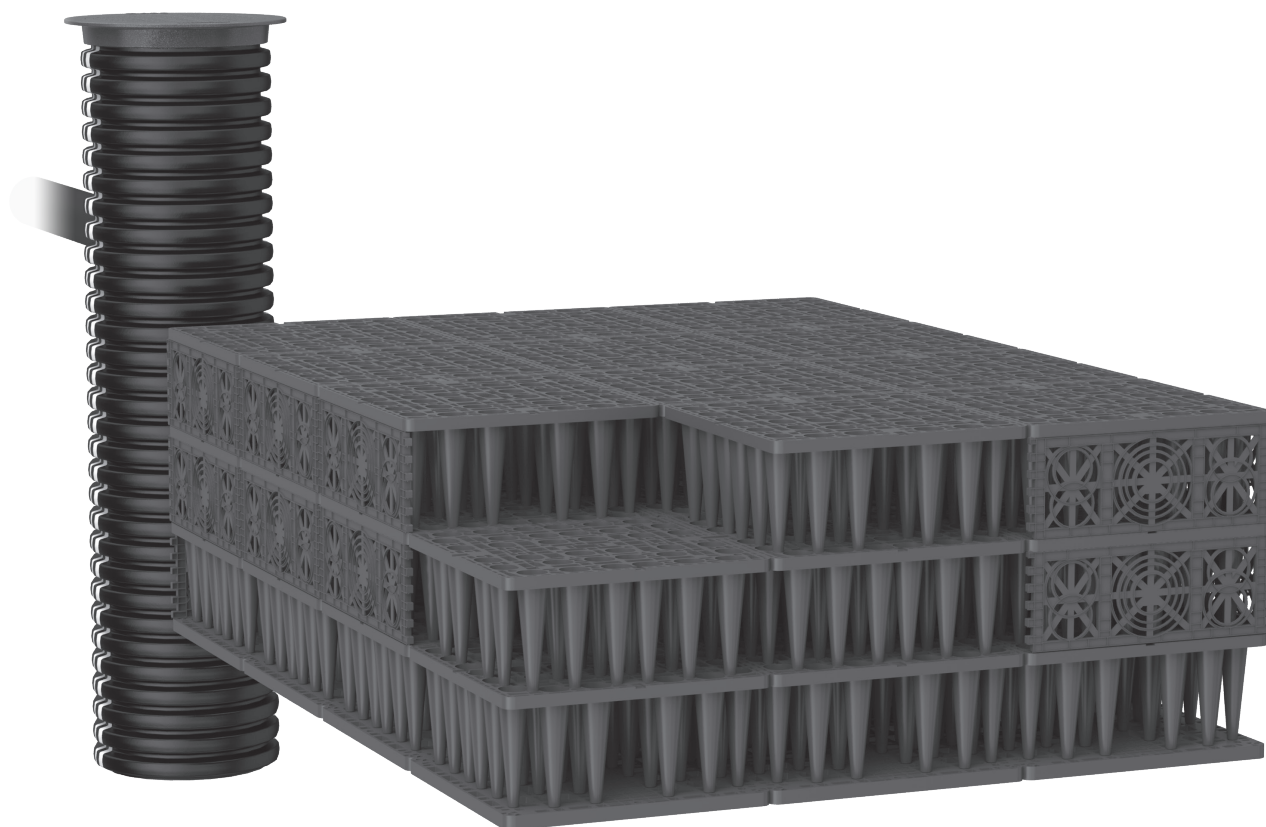

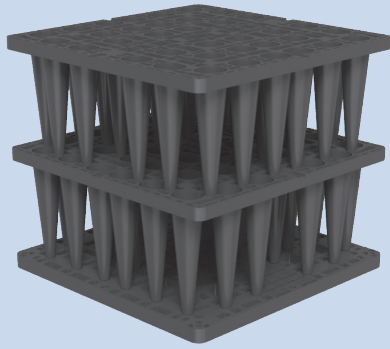

RainBlock Smart system		
Smart	Smart Plus	Smart Ultra
1122168	1122235	1122236
Infiltration	Infiltration	Infiltration
211L	211L	211L

Installation window | Asennusolosuhteet Installationsförhållanden | Installationsbetingelser

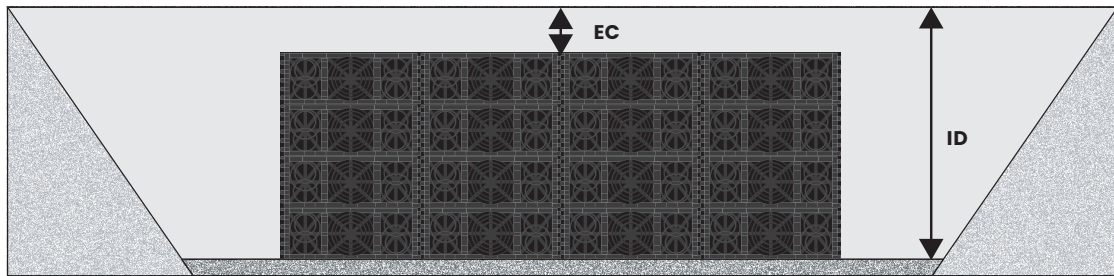

EC - Earth covering, Peittosyvyys, Jordtäckning, Jorddække

ID - Installation depth, Asennussyvyys, Installationsdjup, Installationsdebd

RainBlock					
			Smart	Smart Plus	Smart Ultra
	Min. EC		250 mm	250 mm	250 mm
	Min. EC 40 t		500 mm	400 mm	300 mm
	Max. EC 40 t		2250 mm	2750 mm	4500 mm
	Max. ID		5000 mm	6000 mm	7500 mm

Use of construction machinery in the installation phase

Koneiden käyttö asennusvaiheessa

Användning av entreprenadmaskiner under installationsfas

Brug af entreprenørmaskiner i installationsprocessen

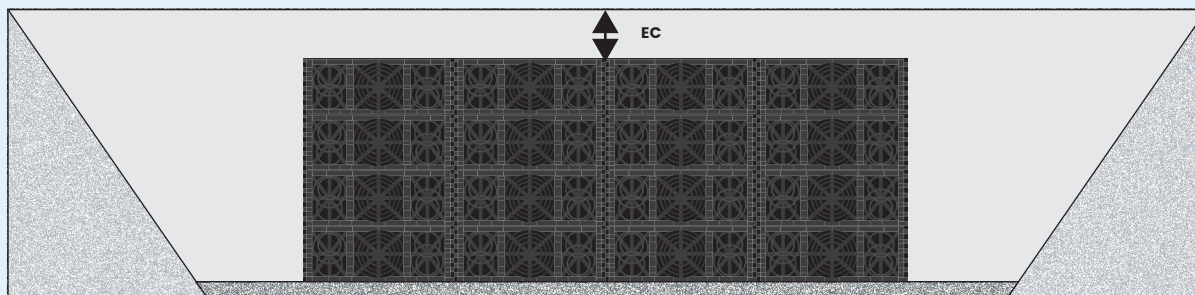

EC - Earth covering, Peittosyvyys, Jordtäckning, Jorddække

RainBlock				
		Smart	Smart Plus	Smart Ultra
	Min. EC ~ 0,7 t	100 mm	100 mm	100 mm
	Min. EC ~ 2,5 t	200 mm	150 mm	100 mm
	Min. EC ~ 7,5 t	300 mm	250 mm	200 mm
	Min. EC ~ 12 t	500 mm	300 mm	250 mm
	Min. EC ~ 40 t	500 mm	400 mm	300 mm

Note! Compression equipment with active vibration motors must not be taken over the area.

Huom! Alueen päällä ei saa tehdä täryttävää maantiivistämistä.

Notera! Installationsutrustning med vibratorer får inte användas ovanpå kassetterna.

Bemærk! Bladvibrator til jordpakning må ikke anvendes på pladsen.

Site of installation | Asennuspaikka Installationsplatsen | Installationssted

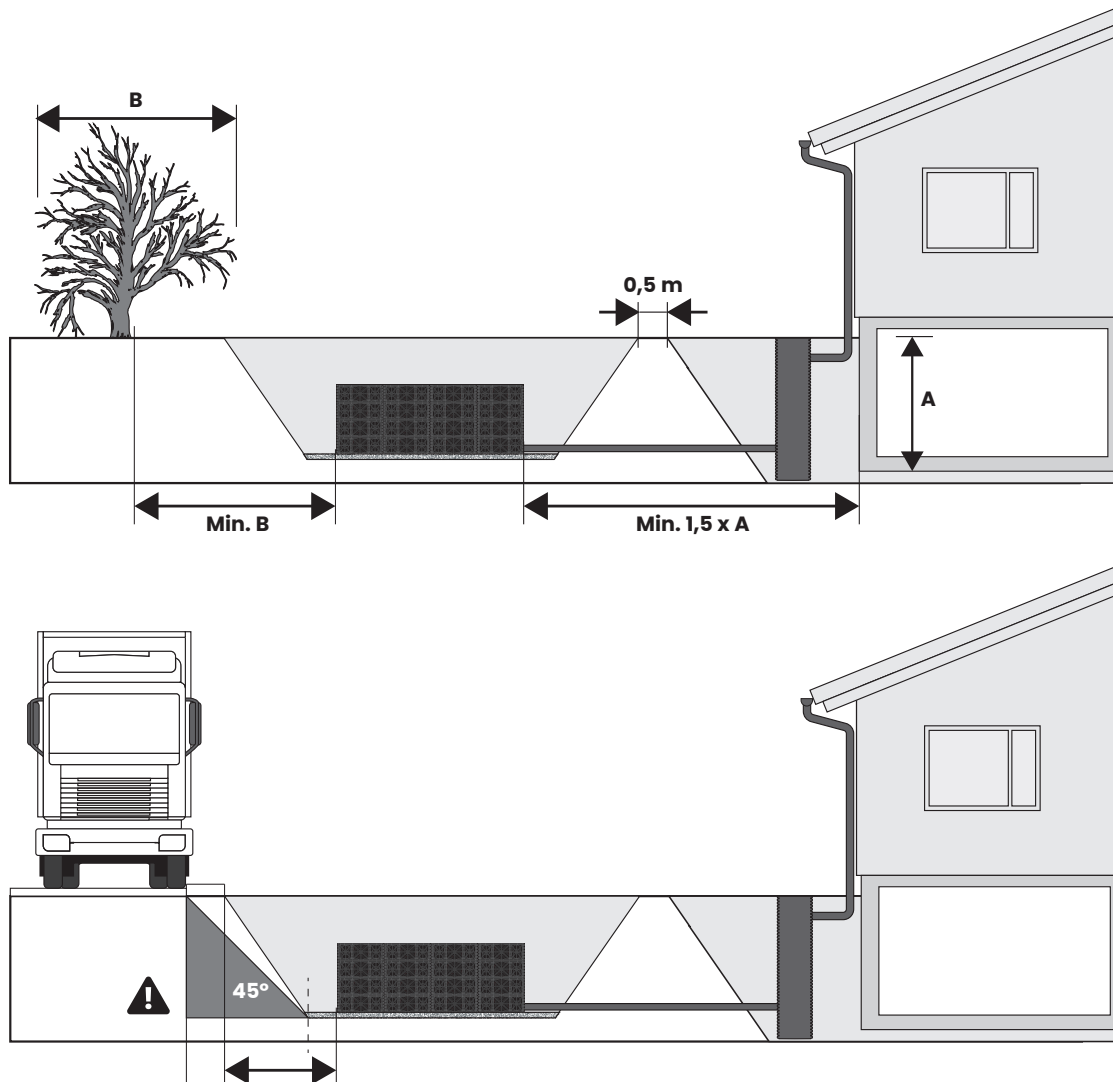

Tools and supplies
Työkalut ja tarvikkeet
Verktøy og utrustning
Værktøj og forsyninger



Product range | Tuotevalikoima

Sortiment | Produktsortiment

Blocks Kasetit Kassetter	Bottom plate Pohjalevyt Bottenplatta Bundplader	Side plate Sivulevyt Sidoplatta Sideplader	Connectors Liittimet Sprintar Clips	Filter textile Suodatinkangas Geotextil Filtertekstil
A	B	C	D	E
1122168 1122235 1122236	1122169	1122170	1085258	

Installation and assembly | Asennus ja kokoonpano

Installation och montering | Installation og montag

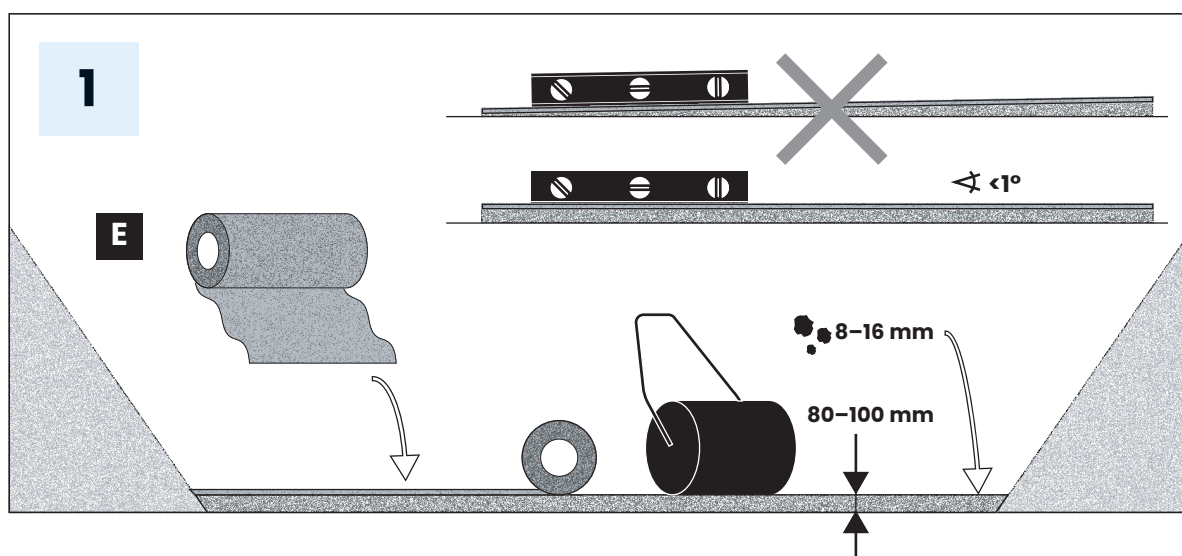

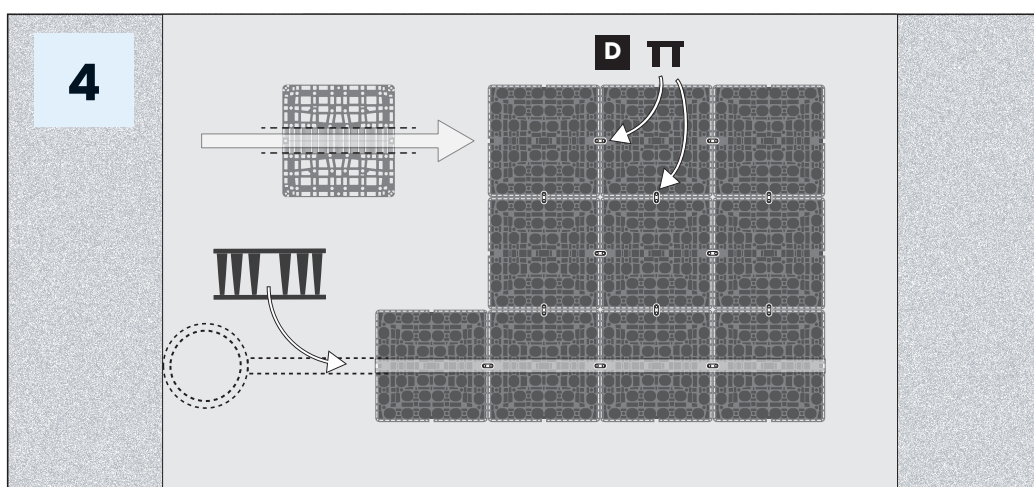
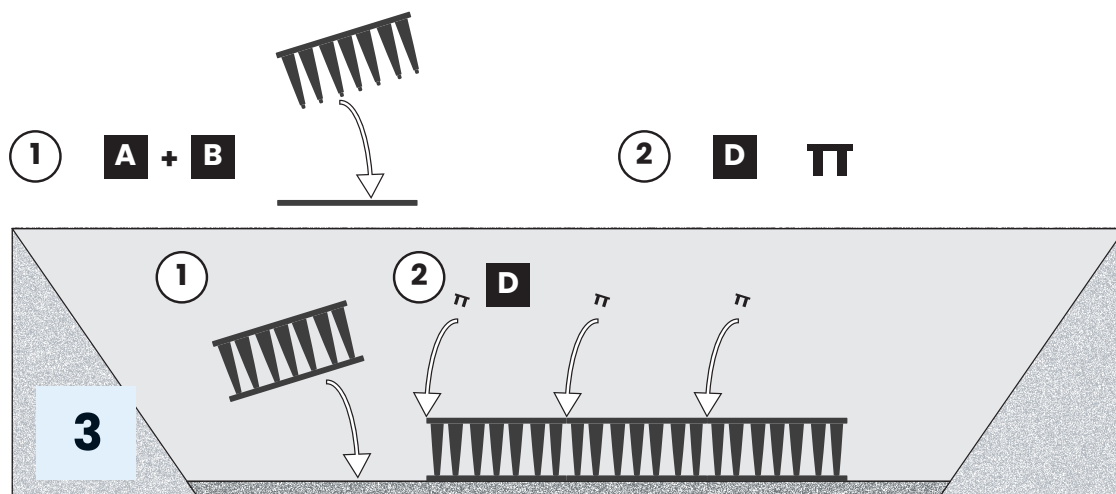
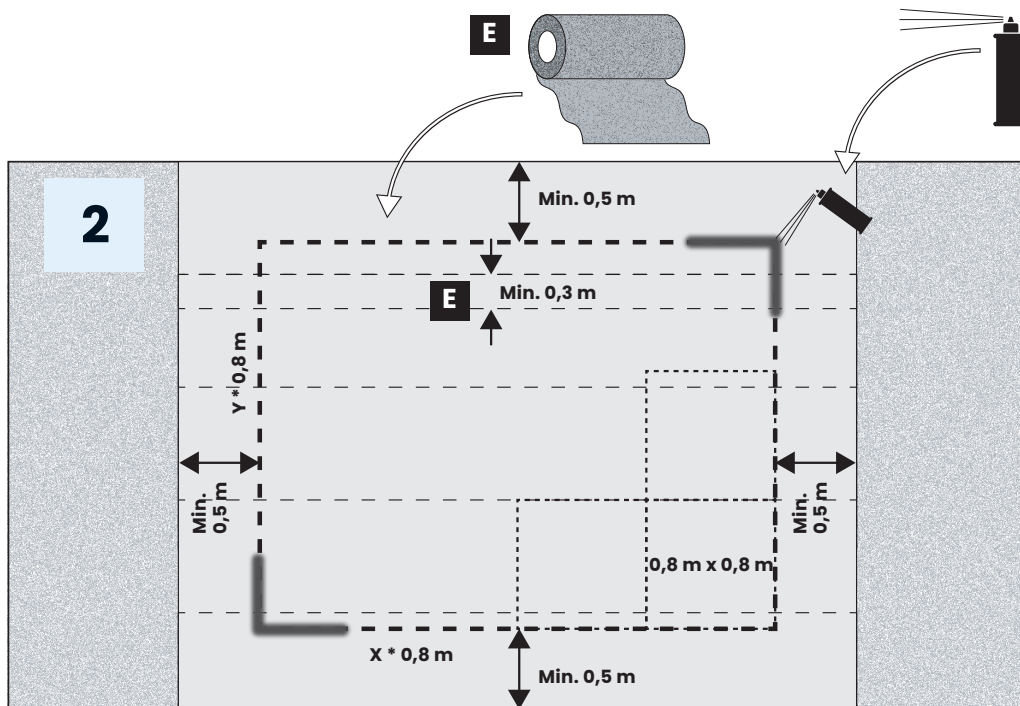

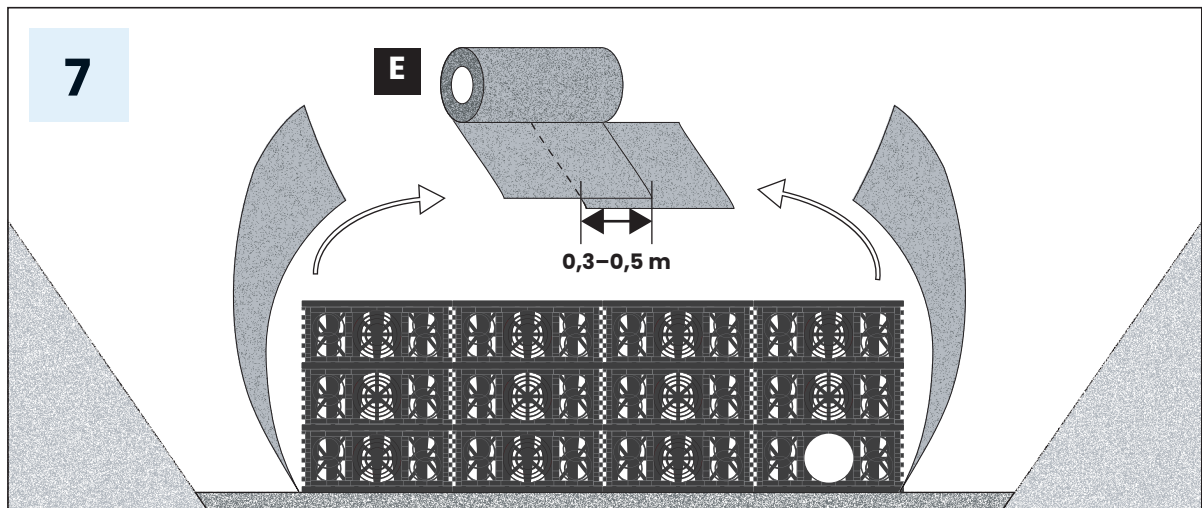
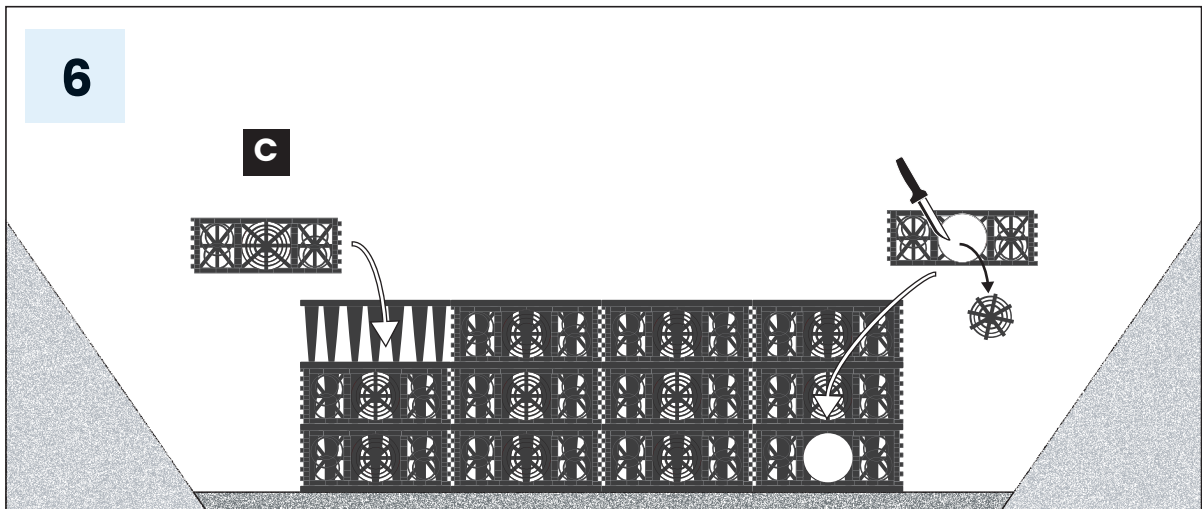
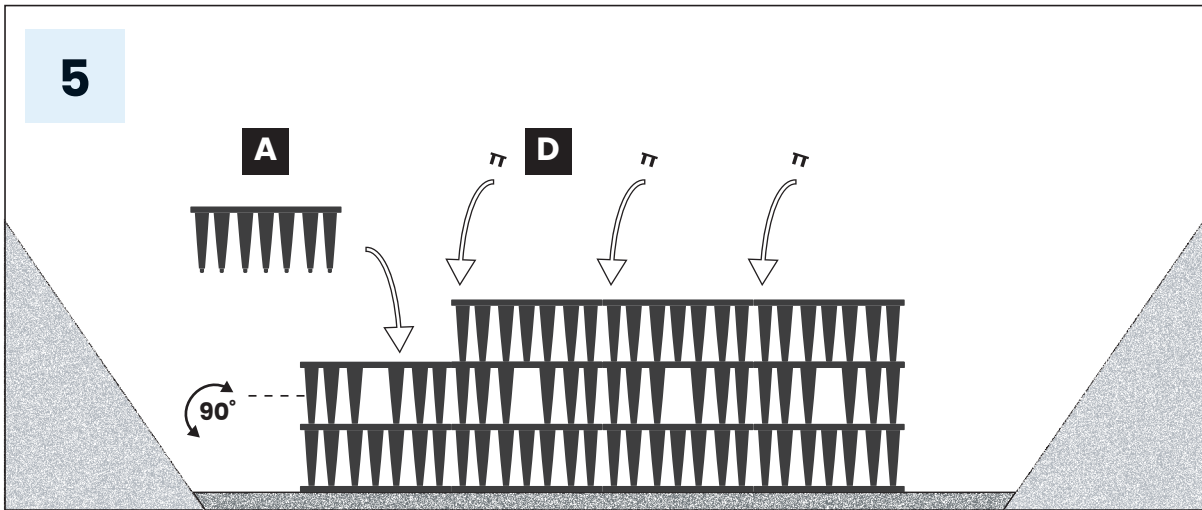

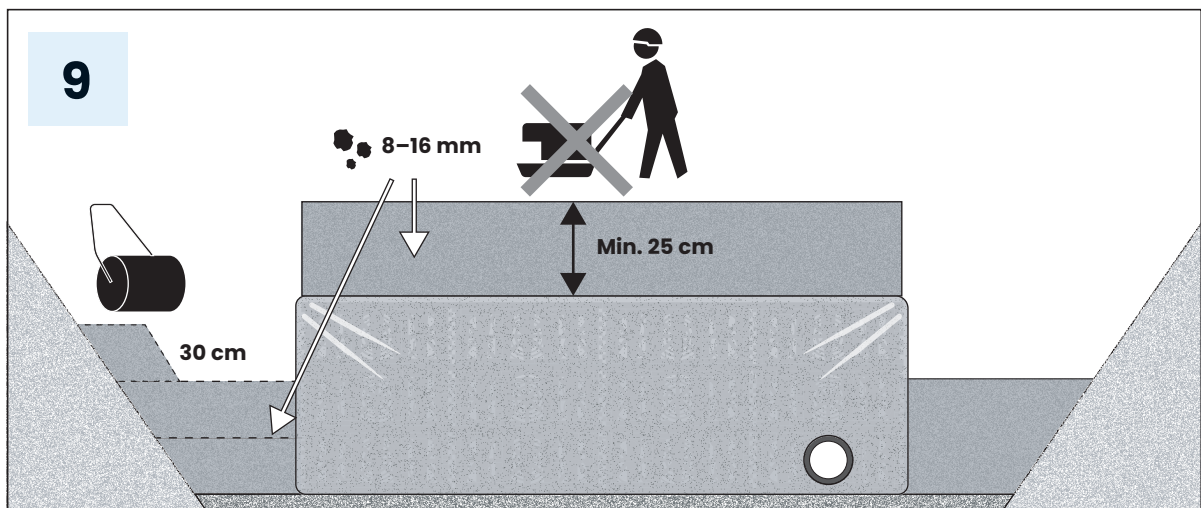
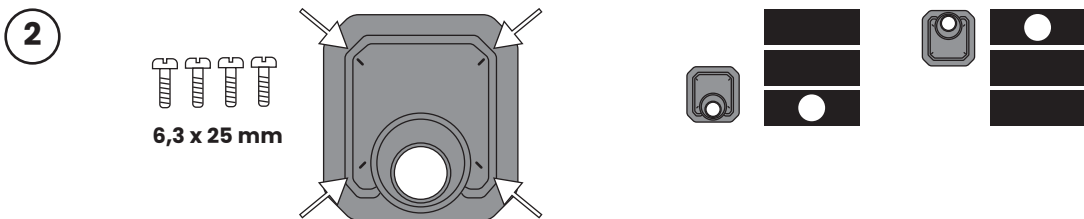
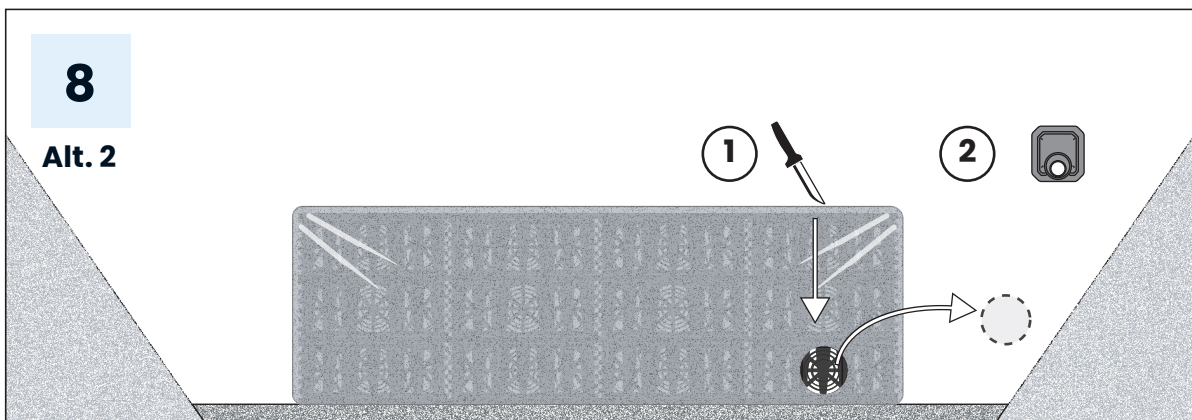
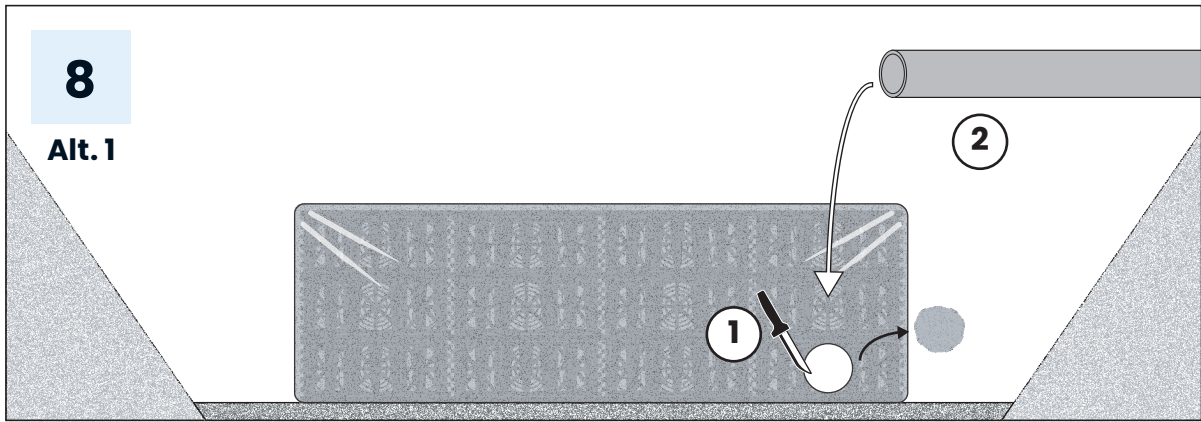

Moving > Forward

uponor

Uponor Infra Oy

PL 21

15561 Nastola

P 020 129 211

E asiakaspalvelu@uponor.com

www.uponor.com/fi-fi