

**uponor**



# **Smatrix Instruction Manual**

# Contents

<b>Interface layout</b>	<b>1</b>	Regional set	15
Home screen	1	Time format	15
Main menu	2	Date format	15
Room menu	3	Temperature unit	16
<hr/>		Date/Time	16
<b>Settings</b>	<b>4</b>	Setting the time	16
ECO setback	4	Setting the date	17
Programming	5	<hr/>	
Navigate to programme schedule (individual rooms)	5	<b>Alarms</b>	<b>17</b>
Navigate to programme schedule (system)	5	<hr/>	
Select a programme schedule (room or system)	6	<b>Individual room control</b>	<b>18</b>
Setting custom profiles (room or system)	6	Room status	18
Copy function	8	Room settings	18
Valve/Pump exercise	8	Room ECO setback	18
Supply diagnostic	8	Room ECO profiles	19
Autobalance	8	Max set point	19
Room check	9	Min set point	19
Room bypass	9	Floor temp limit maximum	19
SD card	9	Floor temp limit minimum	19
<hr/>		Comfort setting	19
<b>Holiday mode</b>	<b>9</b>	Thermostat override	20
Enable holiday mode	9	Room use for average calculation	20
Cancel holiday mode	11	Room name	21
<hr/>		<hr/>	
<b>Trends</b>	<b>11</b>	<b>Setting the temperature (interface)</b>	<b>21</b>
<hr/>		<hr/>	
<b>System Information</b>	<b>11</b>	<b>Thermostat usage</b>	<b>22</b>
<hr/>		Thermostat Digital T-168/T-148/T-166/T-146	22
<b>Preferences</b>	<b>11</b>	Thermostat Dial T-165/ T-145	23
Language	11	Thermostat Sensor T-161/T-141	23
Display	12	Thermostat Public T-163/T143	23
Backlight	12	Thermostat Style T-149/T-169	24
Return screen setting:	12		
Screen saver	13		
Switch off backlight during night period	13		
Screen lock	13		
Screen cleaner	14		

# Introduction

Thank you for purchasing the Uponor Smatrix Control System.

Below you will find instructions to help you programme your new system and obtain optimal performance going forward.

It is important to note that not all settings are covered in this guide. Additional settings, which are not covered, should have initially been set-up when your system was commissioned. If any of these additional settings need to be changed, please contact your local installer.

All of the information in this guide is correct at the time of printing. Any updates or changes made to the Smatrix unit may render sections of this guide redundant.

Finally, we hope that you enjoy your new Uponor Smatrix system!

**Installers:** This guide is designed to be left with your customer as a reference on how to set-up and control their system. If you require information on installation and commissioning the system, please refer to the Smatrix installation guide.

# Interface layout

## Home screen

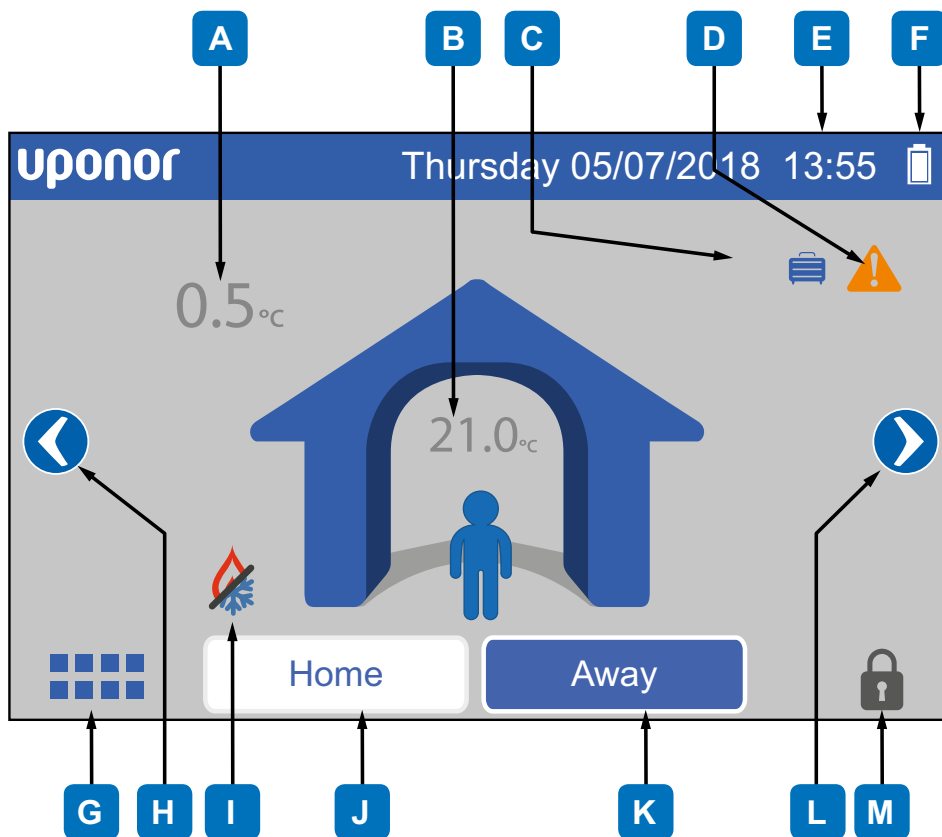

**A.** Outdoor temperature  
(requires outdoor temperature sensor)

**B.** Indoor temperature

**C.** Holiday mode enabled

**D.** Alarms

**E.** Date and time

**F.** Battery power indicator

**G.** Main menu

**H.** Left button, takes you back to the last room menu

**I.** Heating/Cooling mode indication

**J.** Home button, activates Comfort mode

**K.** Away button, activates ECO mode

**L.** Right button, go to the first room menu

**M.** Screen lock



## Main menu

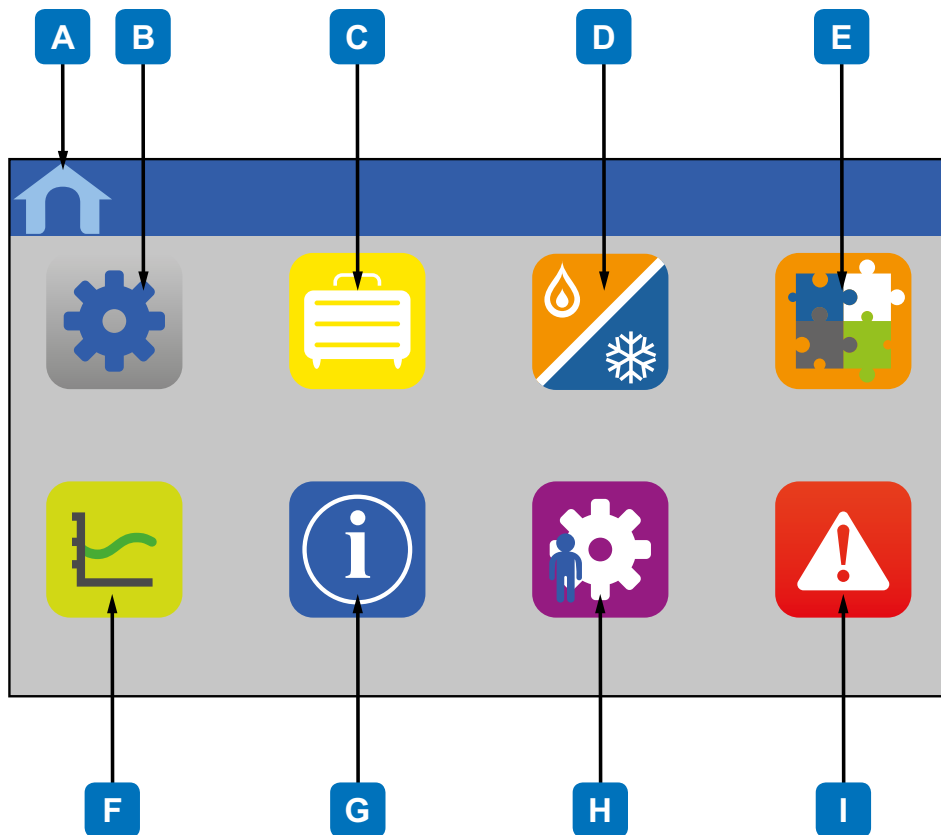

- A.** House – returns to main menu
- B.** Settings – setting for the heating/cooling system
- C.** Suitcase – enable holiday mode
- D.** **Heat/Cool – not covered in this user guide\***
- E.** **Integration – not covered in this user guide\***
- F.** Trends – shows a 7 day profile of the temperatures inside your dwelling (and outside if an outdoor sensor has been fitted). It also gives total usage for individual rooms.
- G.** System information – provides the current software versions installed
- H.** Preferences –set up the interface
- I.** Alarms – shows any current alarms in the system

This guide has been set out following the icons on the main menu grid above. From the main menu, the majority of settings can be adjusted for your system.

**\*Please note, items we recommend that you do not change could alter how your system performs. These settings should only be altered by your installer or via an Uponor support technician.**

## Room menu

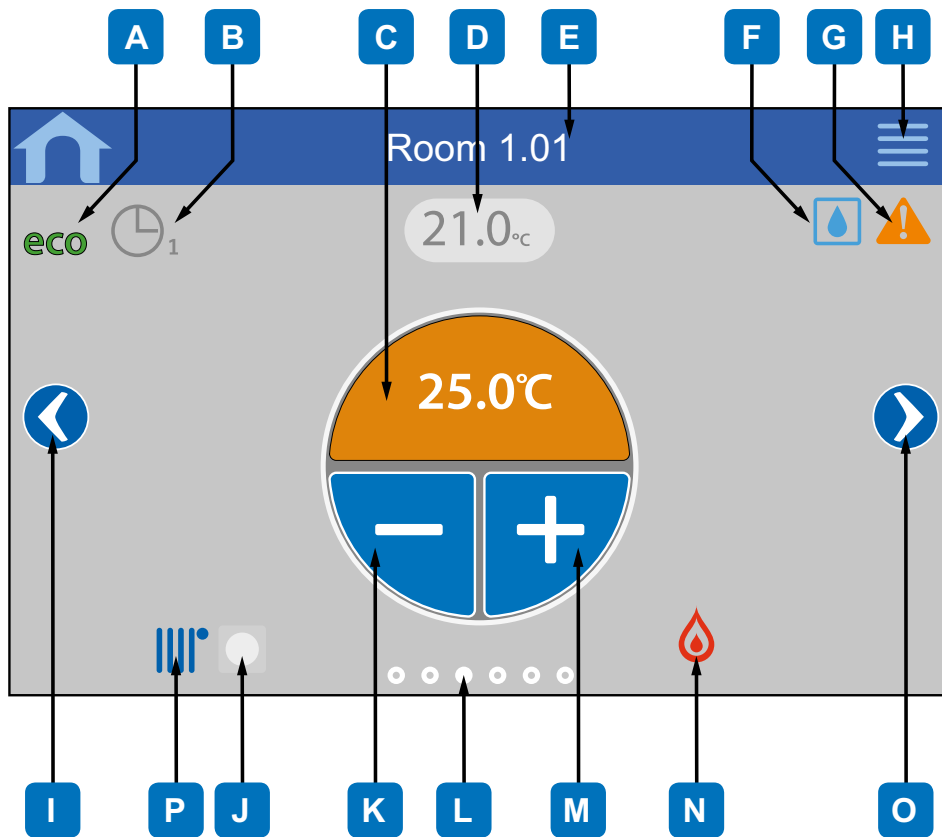

- A.** ECO mode activated
- B.** Time programme activated. Number indicates which program
- C.** Set point temperature. The background colour changes if the system is in heating (orange) or cooling mode (blue).
- D.** Current room temperature
- E.** Current room name (editable in room settings)
- F.** Relative humidity limit reached\*
- G.** Active alarms in alarm menu
- H.** Advanced room information
- I.** Left button, to move to next thermostat
- J.** Remote thermostat indication
  - Blue indicates that you are receiving the set point from a dial or public thermostat
- K.** Decrease set point temperature
- L.** Current room menu indication
- M.** Increase set point temperature
- N.** Heating/cooling mode indication\*
- O.** Right button, go to the next room menu
- P.** Thermostatic head indication. Only shown when a wireless radiator head is registered to the zone
  - Grey indicates that the dial or public thermostat is overridden by the interface
  - It is hidden if there is no dial or public thermostat in use within the current room

The majority of settings for each individual room can be adjusted using the icons above.

\*Will only ever appear if cooling mode was enabled when the system was installed.

# Settings

## ECO setback

All Uponor systems operate using a setback control function, which provides a temperature for both the “on” and “off” times. For optimal efficiency of your new underfloor heating (UFH) system, we recommend running a setback of 4°C. This means, during the “on” period if you set a thermostat at 20°C with a setback of 4°C, the system will automatically top up when the room reaches below 16°C. If you do wish to change the gap between the on and off temperature, please follow the instructions below:

1. From the Home screen



 Changes the highlighted value

 Confirms any changes made

 Cancels any changes made

**Note** – this will apply the setback temperature throughout the entire system and override any previous individual settings you have scheduled. To change individual rooms please see **page 5**.

## Programming

On all Uponor interface systems you can choose to set times for your thermostats individually via each thermostat (see navigate to programme schedule – rooms) and set different timings for each room. Or you can choose to time all your thermostats exactly the same (Refer to navigate to programme schedule system below) via two slightly different navigations.

### Navigate to programme schedule rooms



**CAUTION!** This will only change the thermostat you select and will not alter any other thermostats on the system.

1. From the Home screen



Use arrows to select room to change



Room settings

ECO profiles: No ECO

2. Select your preferred ECO profiles (See below)

### Navigate to programme schedule system



**CAUTION!** In altering the settings through the system, it will override all individually set times on each thermostat within your system.

1. From the Home screen select:



System ECO profiles

## Select a programme schedule (room or system)

- Once you have navigated to the programme schedule (see **page 5**), select your preferred programme (see below for pre-set timings):

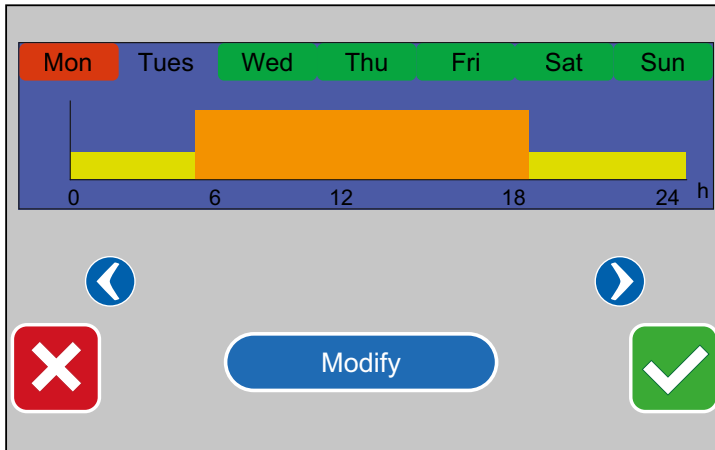

Navigates through the set programmes (see below for times)



Confirms any changes made



Cancels any changes made

### Pre-set programmes

- No ECO:** System active all hours
- P1:** Active during the mornings and in the evenings Monday-Friday, on all day Saturday-Sunday
- P2:** Active during the mornings and in the evenings Monday-Sunday
- P3:** Active in the evenings Monday-Friday and also all day Saturday-Sunday
- P4:** Active all day Monday-Sunday
- P5:** Off all day Monday-Friday, on all day Saturday-Sunday
- Custom:** See setting custom profiles

## Setting custom profiles (room or system)

If none of the above programmes suit, you can change the times to best fit your lifestyle. Depending on where you set this up, it will either apply to the whole system or you can set individual custom times to each thermostat. For example, the bedroom could be “on” whilst other areas are “off”.

- Once you have navigated to the programme schedule (see **page 5**)



Navigate to custom

2. Before starting, it is recommended that you familiarise yourself with this screen and its functions (see below).

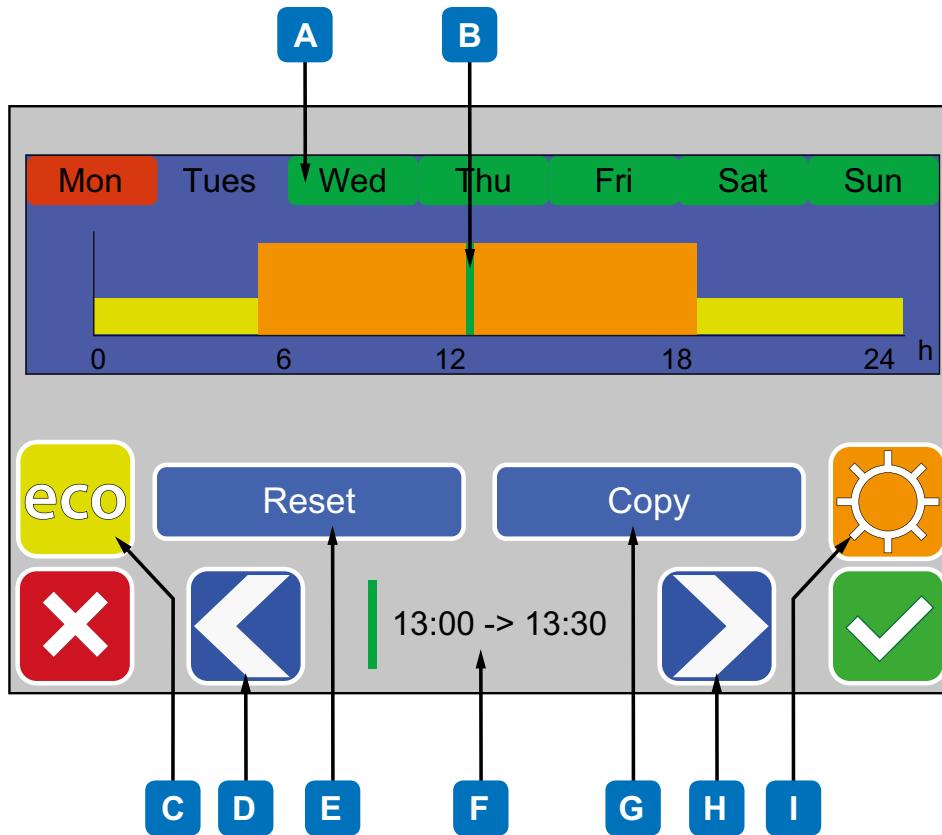

- |   |   |
|---|---|
| <p><b>A.</b> Date selection</p> <p><b>Red:</b> All days have been reset</p> <p><b>Blue:</b> Day has been selected</p> <p><b>Green:</b> Day is not selected for change</p> <p><b>B.</b> Position of programming marker (30 minute interval)</p> <p><b>C.</b> Program ECO (off) mode (30 minute interval)</p> <p><b>D.</b> Move marker left</p> | <p><b>E.</b> Reset the custom schedule to default values (recommended on new programmes)</p> <p><b>F.</b> Time of day for programming marker</p> <p><b>G.</b> Copy a schedule in from another program</p> <p><b>H.</b> Move marker right</p> <p><b>I.</b> Program Comfort (on) mode for marked 30 minute interval</p> |
|---|---|

3. Select reset to clear any last programs.



4. Select the days you wish to have as the same programme. As you select the days they turn blue.

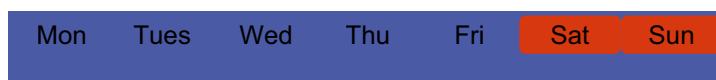

5. Using the following keys; move through the day changing the profile to suit your needs:



Position of programming marker (30 minute interval)



Change marked time to ECO (off)



Move marker left or right





Change marked time to Comfort (on)



Confirm the time changes made



Cancels any time changes made

6. Repeat steps 4 & 5 for the remaining red days.
7. Once complete press  (confirm) or  (to cancel)
8. It will ask you a final time to confirm your changes
9. Your programme is now set

## Copy function

In any custom profile, you have the option to copy a pre-set profile from another room or import one of the main pre-set programmes and make changes. To do this you must be in the custom profile screen of the room you want to copy to. See [page 5](#).

1. Press: 
2. It will then ask which profile you want to copy from.



Navigate through the programmes using the arrows to the one you want to copy from



Accepts the copy of the programme



Cancels the copy of the programme

## Valve/pump exercise

This should be set by your installer to **valve and pump**, as it enables your system during long shutdown periods to switch on regardless of what is set on the thermostats. The valve will open to operate the pump and this limits the damage to the system.

## Supply diagnostic

This should be set by your installer to **Active**. Essentially this means if you have any future system issues, a log is saved to the SD card which the Uponor support team can use to diagnose issues.

## Autobalance

This should be set by you installer to **Active**, as it will enable your system to react to changes in operation over its life. If this is **Inactive**, then please **do not** change this as your system could have been manually balanced.





## Room check

For installer use only

## Room bypass

In this screen you should not see any . If one appears press to change to a .

If any bypasses are enabled this will operate the thermostats in these areas regardless of “their” set point. This is only ever used when the system is first installed.

Room bypass		
Controller1		
Rooms	Activation	
Any room name		
Room 01 02		
Room 01 03		
Room 01 04		

## SD card

For installer use only

## Holiday mode

Enabling holiday mode will allow you to set a system wide temperature.

This will operate for a given time and then revert back to a normal system operation once that time has expired. This feature is ideal for frost protection during winter months.

## Enable holiday mode

1. From the Home screen select:





2. Select start date

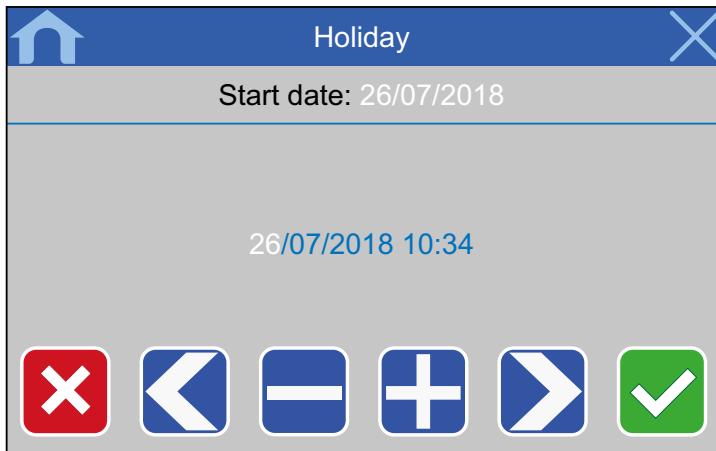

Navigates to the setting you wish to change (white text is the value to change)



Changes the highlighted value



Confirms any changes made



Cancels any changes made

3. Set the end date (same setup as step 2)

4. Set away temperature

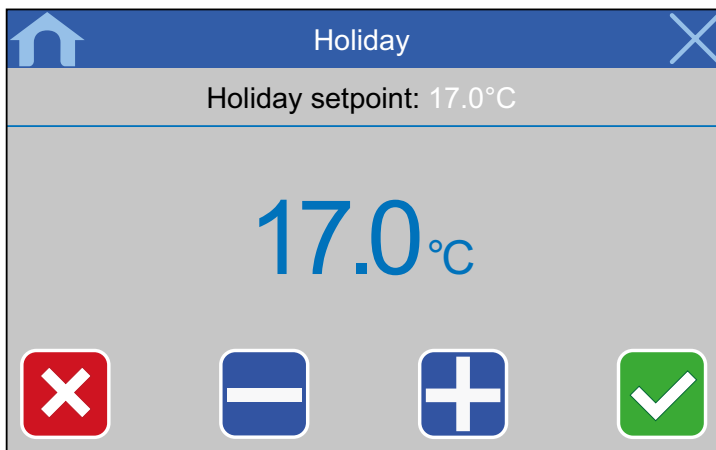

Changes the holiday set point temperature



Confirms any changes made



Cancels any changes made

5. On the last screen it will ask you to confirm the holiday mode setting



Confirms holiday mode



Cancels holiday mode

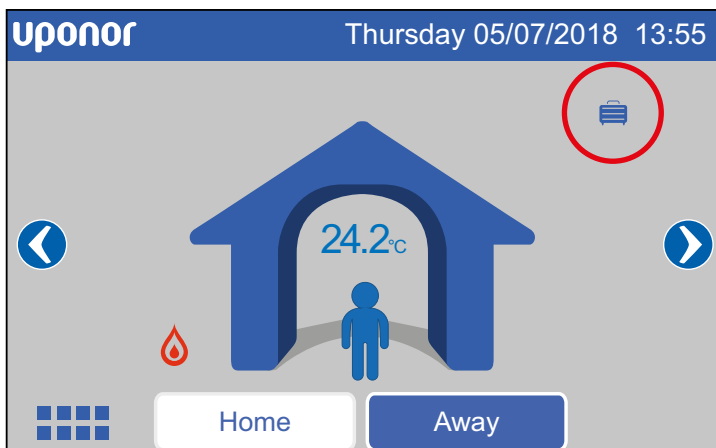

**Note!** When holiday mode is enabled a suitcase will be shown on the Home screen.

## Cancel holiday mode

Holiday mode will automatically cancel when the end date is reached. If you wish to cancel this earlier, please follow the instructions below:



On the Home screen press the suitcase button

Yes

Cancels holiday mode

No

Continues with holiday mode

## Trends

Trends is an information screen which shows how the system is performing, what areas are used the most and changes in the indoor temperatures.

## System information

This screen gives information on the software version that is currently running on the controller and interface.

## Preferences

### Language

The default language for the system is English. To change the language, please follow steps 1 & 2:

1. From the Home screen select:



2. Select the correct language by pressing the correct flag



Navigates through to more languages



Confirms language selection



Cancels language selection

# Display

## Backlight



This alters the screen's backlight to ensure it is visible in all light conditions.

1. From the Home screen select:

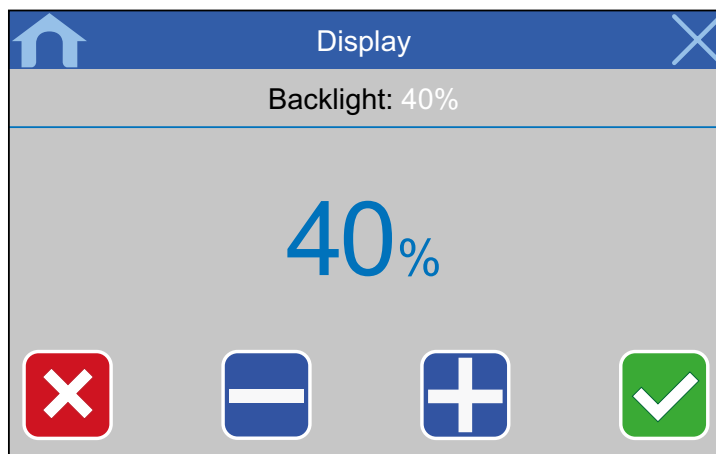

2. Change to the required brightness



-  Changes the highlighted value
-  Confirms any changes made
-  Cancels any changes made





## Return Screen Setting

If your device is inactive for 3 minutes, it will default back to the Home screen. This can be changed to show alarms or the trend graphs. Please note, it will only appear after inactivity and not by pressing the home button. To change this:

1. From the Home screen select:



2. On the next screen:

-  Returns to the Home screen (white shows selection)
-  Returns to the Alarm screen (white shows selection)
-  Returns to the Trends screen (white shows selection)
-  Confirms any changes made
-  Cancels any changes made

## Screen saver

Once the screen saver is active, the return screen will appear after 3 minutes of inactivity (lock if the screen lock is enabled) and dim the brightness to around 10%. It will illuminate again when touched.

- From the Home screen select:



- Active**      Activate screen saver (white shows selection)
- Inactive**      Deactivate screen saver (white shows selection)
- Confirms any changes made
- Cancels any changes made

## Switch off backlight during night period

When activated between the hours of 22:00 and 07:00, the screen will shut down after 3 minutes of inactivity. It will start again when touched.

- From the Home screen select:



- On the next screen:
  - Yes**      Switch back light on (white shows selection)
  - No**      Switch back light off (white shows selection)
  - Confirms any changes made
  - Cancels any changes made

## Screen lock





A screen lock can be enabled to provide security to your system. This is in the form of a 4 digit passcode. When enabled and the screen has been left for 3 minutes, it automatically locks. Entering the set passcode is the only way you can access the system and change the settings.

### To Enable/Disable

- From the Home screen select:



2. On the next screen:

-  **Active**      Activate pass code (white shows selection)
-  **Inactive**      Deactivate passcode (white shows selection)
-       Confirms any changes made
-       Cancels any changes made

**Note:** if you have set a passcode previously, then you need to press  to set a new passcode.

3. Enter a 4 digit pin code and press  to set or  to cancel.

**NOTE!** After 3 minutes of inactivity the interface returns to the Home screen. A padlock will now appear locking the touchscreen to the Home screen.

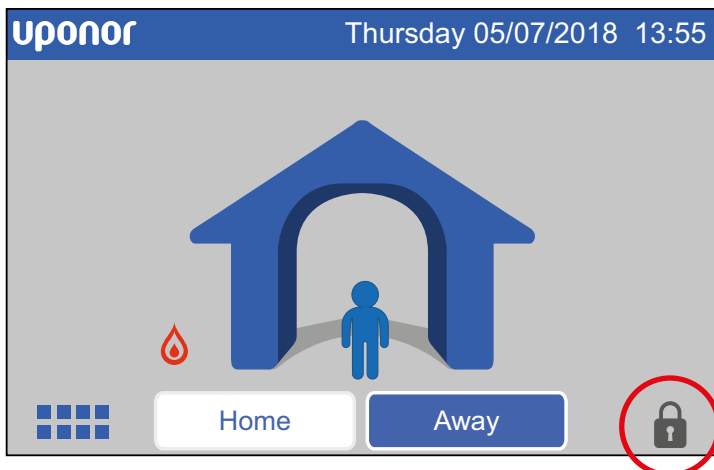

**To unlock**

On the Home screen press the . Enter the set passcode and press .

**Forgotten passcode**

If you have forgotten the screen lock passcode, you can use the master passcode which will override any previously set pass code. Following this, see the above 'To enable/disable' for how to remove or change your pass code.

**Master pass code: 7365**

**Screen cleaner**

This enables a 30 second window in which you can clean the screen without changing the settings. **We recommend using only a dry, lint free cloth for cleaning.**

1. From the Home screen select:



It will now count down from 30 seconds, whilst locking the screen.



# Regional set

## Time format

This changes the time format shown on the screen.

- From the Home screen select:





- AM/PM** Sets to a 12 hour clock (white shows selection)
- 24hr** Sets to a 24 hour clock (white shows selection)
-  Confirms any changes made
-  Cancels any changes made

## Date format

This changes the date format shown on the screen.

- From the Home screen select:



- DD/MM/YYYY** Sets the day first – numerical format (white shows selection)
- DD Mmm YYYY** Sets the day first – text format (white shows selection)
- YYYY/MM/DD** Sets the year first – numerical format (white shows selection)
- YYYY Mmm DD** Sets the year first – text format (white shows selection)
-  Confirms any changes made
-  Cancels any changes made

### Temperature unit

This changes the temperature unit shown on the screen

1. From the Home screen select:



**°C** Set to degrees Centigrade (white shows selection)

**°F** Set to degrees Fahrenheit (white shows selection)

Confirms any changes made

Cancels any changes made

## Date/Time

### Setting the time

To change the time of the interface:

1. From the Home screen select:



2. Set the correct time:

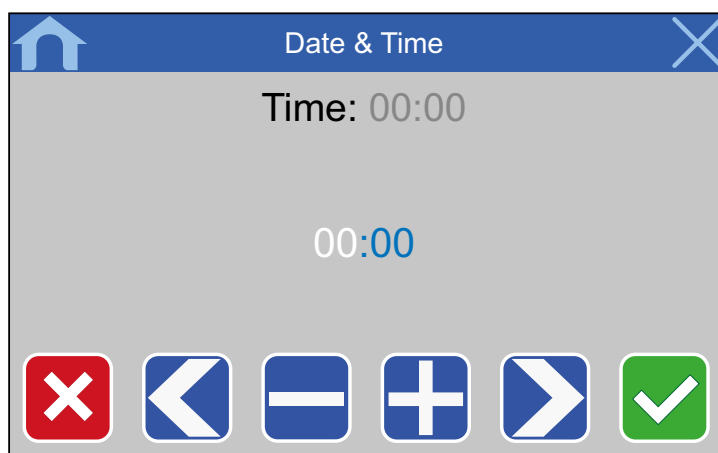

Navigates to the setting you wish to change (white text is the value selected)

Changes the highlighted value

Confirms any changes made

Cancels any changes made

### Setting the date

To change the date of the interface:

1. From the Home screen select:



2. Set the correct date by:

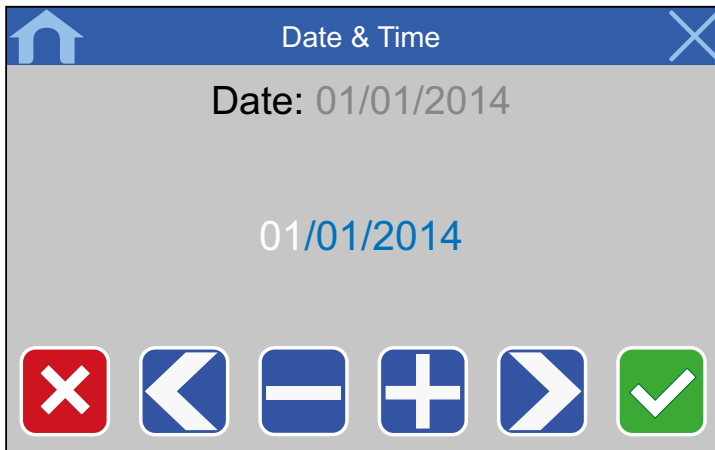

Navigates to the setting you wish to change (highlighted text is the value to change)



Changes the highlighted value



Confirms any changes made



Cancels any changes made

# Alarms

The Alarms menu contains information on current system issues. It will provide information on what type of alarm it is, where it is (room) and when it occurred (time). Only the latest ten alarms are shown in this menu. Alarms older than this are deleted automatically.

All alarms are logged with a time stamp on the controller microSD card.

This can be accessed in one of two ways.

1. Press the alarm symbol on the Home screen if it is visible.

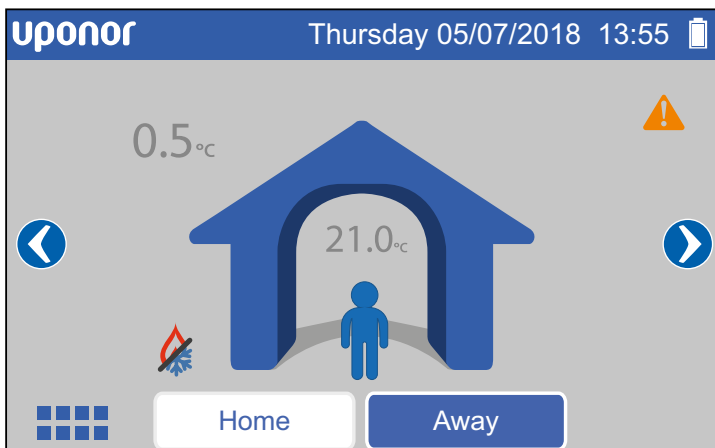

Or



- On the Home screen select:

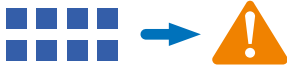

It is recommended that before trying any of the above to press

**Delete all**

This clears any old alarms. If the item reappears then the fault remains.

# Individual room control

## Room status

Room Status gives an overview on individual rooms and how they are working. They also indicate issues and if the room is currently switched on or not.

- From the Home screen:



Highlight room  
to change

## Room settings

### Room ECO setback

All Uponor systems operate using a setback control function, which provides a temperature for both the "on" and "off" times. For optimal efficiency of your new underfloor heating (UFH) system, we recommend running a setback of 4°C. This means, during the "on" period if you set a thermostat at 20°C with a setback of 4°C, the system will automatically top up when the room reaches 16°C. If you do wish to change the gap between the on and off temperature, please follow the instructions below:

- From the Home screen:



Highlight room  
to change

 Changes the highlighted value

 Confirms any changes made

 Cancels any changes made

## Room ECO profiles

See programming section on [page 5](#).

### Max set point

Max set point will set the maximum temperature a thermostat can operate at.

1. From the Home screen:

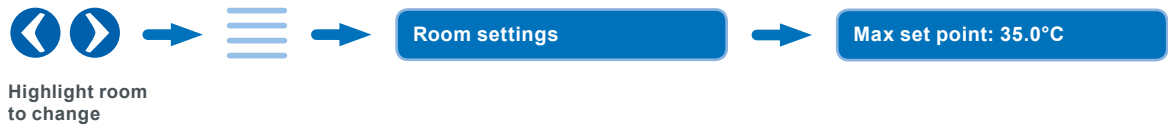

Changes the maximum temperature for the selected thermostat



Confirms any changes made



Cancels any changes made

### Min set point

Min set point will set the minimum temperature a thermostat can operate at.

1. From the Home screen:

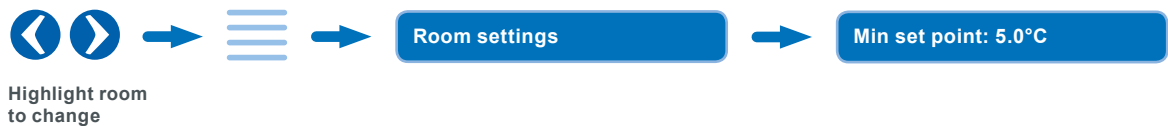

Changes the minimum temperature for the selected thermostat



Confirms any changes made



Cancels any changes made

### Floor temperature limit maximum

Only shown on thermostats with an external sensor wired in. This temperature limit is to protect your floor. This should be set by your installer and must not be changed.

### Floor temperature limit minimum

Only shown on thermostats with an external sensor wired in. This temperature limit is to protect your floor. This should be set by your installer and must not be changed.

### Comfort setting

The comfort setting is used when a secondary heat source within a room is activated. After a set amount of time (in percent) the system will enable, regardless of what the thermostat says. This in turn helps to keep the floor warm.

1. From the Home screen:



Highlight room to change

 Changes the percentage of time the system will call for heat to keep the floor warm

 Confirms any changes made

 Cancels any changes made

### Thermostat Override

Once enabled this allows you to control the dial and public versions of the thermostats at the interface.

**Note! This will then disable the ability to control the thermostat at the wall.**

**This setting only appears on public and dial thermostats.**

1. From the Home screen:



Highlight room to change

 Yes Enables control at the interface (white shows selection)

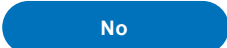
 No Enable control at the thermostat (white shows selection)

 Confirms any changes made

 Cancels any changes made

### Room use for average calculation

When this is enabled, it will calculate the “system” average temperature indoors across all rooms. This temperature is then displayed on the Home screen. If you wish to exclude a specific room, please disable this setting.

1. From the Home screen:



Highlight room to change

 Yes Includes room average (white shows selection)

 No Excludes room average (white shows selection)

 Confirms any changes made

 Cancels any changes made

## Room name

Allows you to rename the thermostats to something more recognisable.

1. From the Home screen:



Highlight room to change

2. Set the Room name:

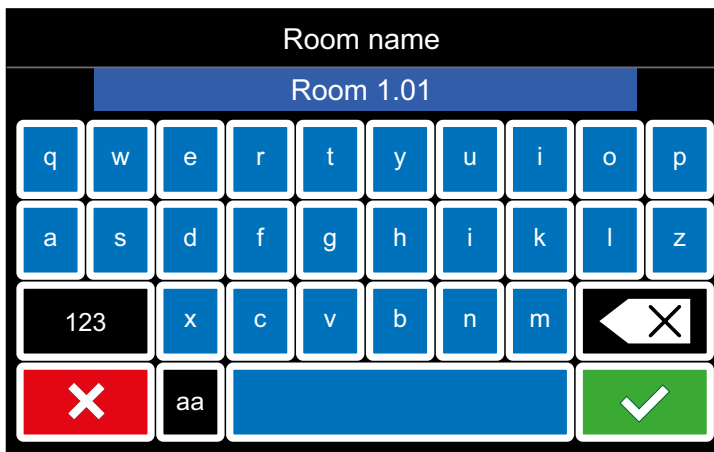

Confirms any changes made



Cancels any changes made

## Setting the temperature (interface)

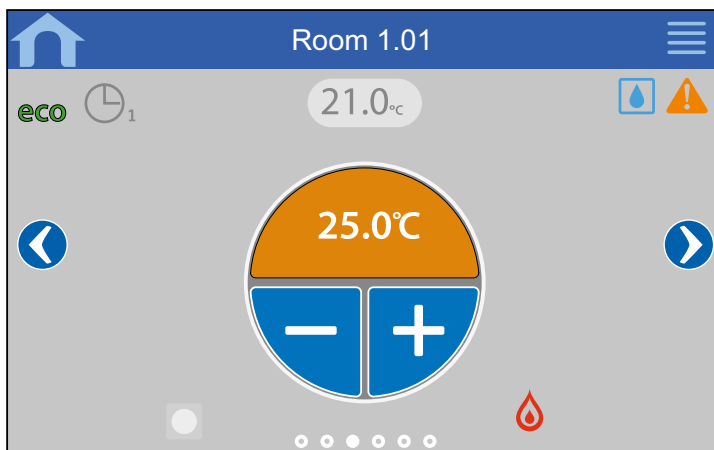

To adjust the temperature in a room:



Navigates to the room you wish to change



Adjusts the set point temperature of the room



**CAUTION!** If the thermostat override is not enabled (public and dial thermostats only), a grey area is shown instead. This means that a set point cannot be changed from the interface. To enable this setting, please see thermostat override on page 20.

# Thermostat usage

## Thermostat Digital T-166/T-146

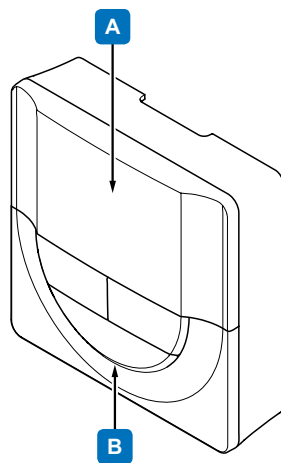

Item	Description
A	Display
B	Buttons

- To increase the set point temperature, press + and to lower the set point temperature press -. Please note you do not have to press OK to accept.

**CAUTION!** Pressing and holding the OK button will take you to the thermostat setting. These settings should only be changed by your installer.

The set point range is 5-35°C.

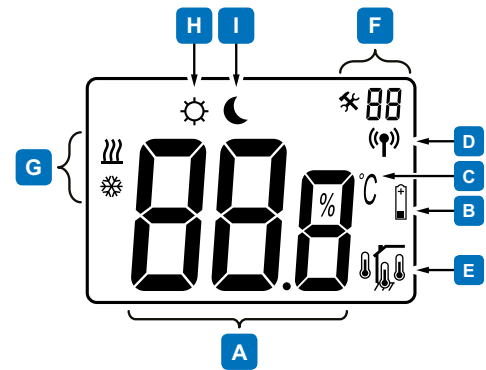

Pos.	Icon	Description
A	000	Message field using three alphanumeric characters
	T-146 00.0	Temperature reading using a - or + sign, two digital characters, a decimal point and a character showing either 0 or 5
	T-148 00.0	Temperature reading using a - or + sign, two digital characters, a decimal point and a character showing either 0 or 5
	00 %	Relative humidity reading using two digital characters. Indicated with a "%" character
B		Low battery indicator
C	°C / °F	Temperature unit, shown when the character group A shows a temperature
D		Communication indicator
E		Indoor temperature indicator
		Remote sensor temperature indicator (RS mode) The text <b>Err</b> and a flashing floor sensor icon indicates a faulty sensor
		Indoor temperature with floor temperature limitation indicator The text <b>Err</b> and a flashing floor sensor icon indicates a faulty sensor
		Floor temperature indicator The text <b>Err</b> and a flashing floor sensor icon indicates a faulty sensor
G		Heating demand
		Cooling demand
H		Comfort mode
I		ECO mode
		Flashing icon in thermostat T-166 or T-167 indicates activated holiday mode in the system

# Thermostat Dial T-165/ T-145

Item	Description
A	Room temperature set point dial control
B	Heating/Cooling demand LED
C	Clear dial guide

1. To increase the set point temperature, turn the centre dial clockwise. To lower the set point temperature turn the centre dial anti-clockwise.

The set point range is 5-35°C. The centre line will be 21°C.

A red LED will show in the bottom right hand corner when calling for heat momentarily after the temperature set point is changed.

If using a Wave or Base PRO interface, you can adjust the temperature via the interface or thermostat. Please note, this is the only way to change the temperature and cannot be controlled via both at the same time. To change this option please read change thermostat override on **page 20**.

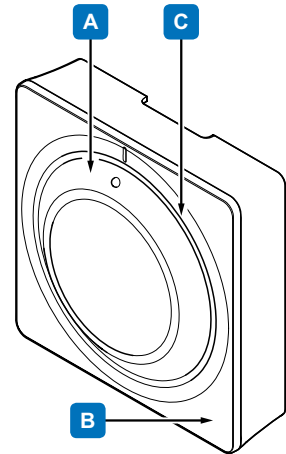

# Thermostat Sensor T-161/T-141

Item	Description
A	Low battery level LED (flashes once every two hours)

Temperature adjustments must be carried out via the touchscreen interface only. To change temperatures please read Setting the Temperature (see **page 21**).

The set point range is 5-35°C.

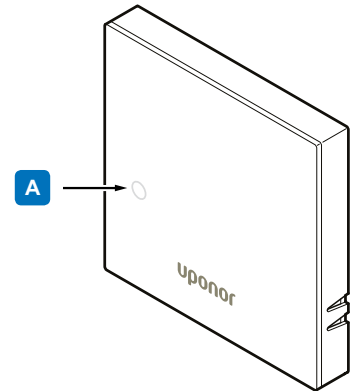

# Thermostat Public T-163/T143

Item	Description
A	Set point temperature potentiometer
B	Heating/Cooling demand LED

2. To adjust the set point temperature, please use a flat headed screwdriver to change the dial. OR

If using a Wave or Base PRO interface, you can adjust the temperature via the interface or thermostat. Please note, this is the only way to change the temperature and cannot be controlled via both at the same time. To change this option please read Change Thermostat Override on **page 20**.

The set point range is 5-35°C.

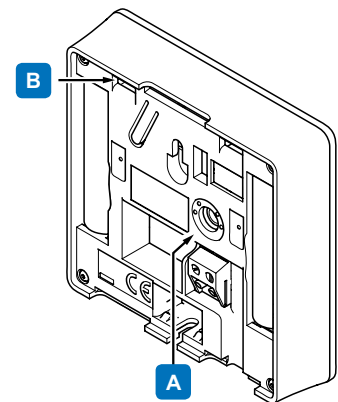

# Thermostat Style T-149/T-169

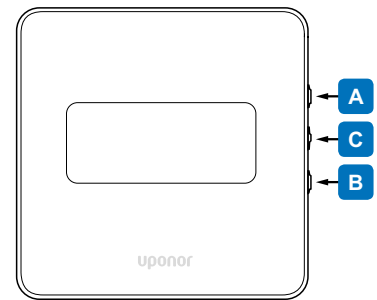

Pos.	Description
A	The - and + buttons are used to: <ul style="list-style-type: none"> <li>• Adjust set point temperature</li> </ul>
B	<ul style="list-style-type: none"> <li>• Modify parameters in the settings menu</li> </ul>
C	The OK button is used to: <ul style="list-style-type: none"> <li>• Toggle between current status data, and values of available sensors connected to the thermostat</li> <li>• Enter and exit the settings menu</li> <li>• Confirm a setting</li> </ul>

## Run mode (default screen)

Pos.	Icon	Description
A	21.0	Temperature reading using a - or + sign, two digital characters, a decimal point and a character showing either 0 or 5
B	⚠	Alarm symbol
C	°C / °F	Temperature unit

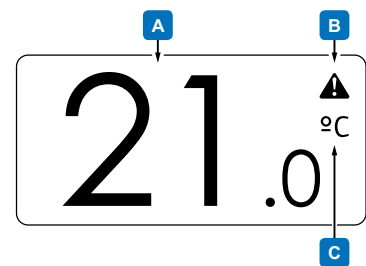

## Change set point

Pos.	Icon	Description
A	🌡	Change set point mode
B	21.5	Temperature set point, using a - or + sign, two digital characters, a decimal point and character showing either 0 or 5
C	°C / °F	Temperature unit
D	🔥	Heating demand
E	❄	Cooling demand
F	⚙	Comfort mode
G	🌙	ECO mode

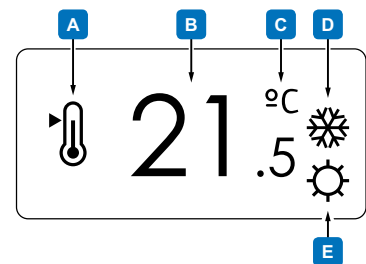

**CAUTION!** Pressing and holding the OK button will take you to the thermostat setting. These settings should only be changed by your installer.

# uponor

Uponor UK  
The Pavilion  
Blackmoor Lane  
Watford  
WD18 8GA  
T +44 (0)1923 927000

[uponor.co.uk](http://uponor.co.uk)