

Uponor



Uponor Smatrix Move PRO



HEATING/COOLING APPLICATION

EN INSTALLATION AND OPERATION
MANUAL

Table of contents

1	Copyright and disclaimer	3
2	Preface	4
2.1	Safety instructions	4
2.2	Correct disposal of this product (Waste Electrical and Electronic Equipment)	4
3	Uponor Smatrix Move PRO	5
3.1	System overview	5
3.2	Example of a system	6
3.3	Uponor Smatrix Move PRO components	7
3.4	Accessories	10
3.5	Functions	10
4	Install Uponor Smatrix Move PRO system	12
4.1	Installation procedure	12
4.2	Prepare for installation	12
4.3	Installation examples	12
5	Install Uponor Smatrix Move PRO controller	23
5.1	Placement of controller	23
5.2	Select controller application	23
5.3	Attach stickers	23
5.4	Insert microSD card	23
5.5	Attach controller to the wall	24
5.6	Terminal cover	24
5.7	Connect sensors to controller	24
5.8	Connect external signal for heating/cooling switch to the controller	36
5.9	Connect mixing valve actuators to the controller	36
5.10	Connect diverting valve actuators to the controller	37
5.11	Connect circulation pumps to the controller	38
5.12	Connect a dehumidifier to the controller	39
5.13	Connect Uponor Smatrix Base PRO controller	40
5.14	Connect Modbus RTU interface	40
5.15	Connect the controller to AC power	41
5.16	Alternate power inputs	41
5.17	Startup wizard	41
5.18	Pre heating concrete slab (DIN 1264-4)	48
6	Finishing installation	50
7	Operate the Uponor Smatrix Move PRO controller	51
7.1	Principle of operation	51
7.2	Controller layout	51
7.3	Navigating the menu system	51
7.4	Start up	52
7.5	Information button	52
7.6	Main menu	53
7.7	System Overview	53
7.8	Information	53
7.9	Alarms	61
7.10	Settings	62
7.11	Pre Heating Info	131
7.12	Pre Heating Settings	133
7.13	Menu tree	140
8	Maintenance	150
8.1	Manual preventive maintenance	150
8.2	Automatic preventive maintenance	150
8.3	Corrective maintenance	150
8.4	Controller display	150
9	Troubleshooting	151
9.1	Troubleshooting after installation	152
9.2	Contact the installer	152
9.3	Installer instructions	152
10	Technical data	153
10.1	Technical data	153
10.2	Technical specifications	154
10.3	Controller layout	154
10.4	Wiring diagram, Uponor Smatrix Move PRO controller	155
10.5	Dimensions	158
11	Installation report	159

1 Copyright and disclaimer

Uponor has prepared this installation and operation manual and all the content included solely for information purposes. The contents of the manual (including graphics, logos, icons, text, and images) are copyrighted and protected by worldwide copyright laws and treaty provisions. You agree to comply with all copyright laws worldwide in your use of the manual. Modification or use of any of the contents of the manual for any other purpose is a violation of Uponor's copyright, trademark and other proprietary rights.

The presumption for the manual is that the safety measures have been fully complied with and, further, that Uponor Smatrix Move PRO, including any components that are part of such system, covered by the manual:

- is selected, planned and installed and put into operation by a licensed and competent planner and installer in compliance with current (at the time of installation) installation instructions provided by Uponor as well as in compliance with all applicable building and plumbing codes and other requirements and guidelines;
- has not been (temporarily or continuously) exposed to temperatures, pressure and/or voltages that exceed the limits printed on the products or stated in any instructions supplied by Uponor;
- remain in its originally installed location and is not repaired, replaced or interfered with, without prior written consent of Uponor;
- is connected to potable water supplies or compatible plumbing, heating and/or cooling products approved or specified by Uponor;
- is not connected to or used with non-Uponor products, parts or components except for those approved or specified by Uponor; and
- does not show evidence of tampering, mishandling, insufficient maintenance, improper storage, neglect or accidental damage before installation and being put into operation.

While Uponor has made efforts to ensure that the manual is accurate, Uponor does not guarantee or warrant the accuracy of the information contained herein. Uponor reserves the right to modify the specifications and features described herein, or discontinue manufacture of Uponor Smatrix Move PRO described at any time without prior notice or obligation. The manual is provided "as is" without warranties of any kind, either expressed or implied. The information should be independently verified before using it in any manner.

To the fullest extent permissible, Uponor disclaims all warranties, expressed or implied, including, but not limited to, the implied warranties of merchantability, fitness for particular purpose and non-infringement.

This disclaimer applies to, but is not limited to, the accuracy, reliability or correctness of the manual.

Under no circumstances shall Uponor be liable for any indirect, special, incidental or consequential damages or loss that result from the use of or the inability to use the materials or information in the manual, or any claim attributable to errors, omission or other inaccuracies in the manual, even if Uponor has been advised of the possibility of such damages.

This disclaimer and any provisions in the manual do not limit any statutory rights of consumers.

2 Preface

This installation and operation manual describes how to install and operate the components of the system.

2.1 Safety instructions

Warnings used in this manual

The following symbols are used in the manual to indicate special precautions when installing and operating any Uponor equipment:



WARNING!

Risk of injury. Ignoring warnings can cause injury or damage components.



CAUTION!

Ignoring cautions can cause malfunctions.

Safety measures

Conform to the following measures when installing and operating any Uponor equipment:

- Read and follow the instructions in the installation and operation manual.
- Installation must be performed by a competent person in accordance with local regulations.
- It is prohibited to make changes or modifications not specified in this manual.
- All power supplies must be switched off before starting any wiring work.
- Do not use water to clean Uponor components.
- Do not expose the Uponor components to flammable vapours or gases.

Uponor cannot accept any responsibility for damage or breakdown that can result from ignoring these instructions.

Power



WARNING!

The Uponor system uses 50 Hz, 230 V AC power. In case of emergency, immediately disconnect the power.

Technical constraints



CAUTION!

To avoid interference, keep installation/data cables away from power cables of more than 50 V.

2.2 Correct disposal of this product (Waste Electrical and Electronic Equipment)



NOTE!

Applicable in the European Union and other European countries with separate collection systems



This marking shown on the product or its literature indicates that it should not be disposed with other household waste at the end of its working life. To prevent possible harm to the environment or human health from uncontrolled waste disposal, please separate this from other types of wastes and recycle it responsibly to promote the sustainable reuse of material resources.

Household users should contact either the retailer where they purchased this product, or their local government office, for details of where and how they can take this item for environmentally safe recycling.

Business users should contact their supplier and check the terms and conditions of the purchase contract. This product should not be mixed with other commercial wastes of disposal.

3 Uponor Smatrix Move PRO

Uponor Smatrix Move PRO is a supply temperature control system for use in different zones. The number of zones and setup vary depending on which application package (supplied with the controller) has been installed (inserting the microSD card into the controller).

This manual only reflects the installation of the controller together with the heating/cooling application package.

Heating application

Using the heating application, enables up to four zones to be setup for heating with different radiant systems (such as underfloor loops, radiators etc.), domestic hot water, or snow melting (keeping large areas clear of snow).

Heating/cooling application

Using the heating/cooling application enables up to three zones to be setup for heating and/or cooling with different radiant systems (such as underfloor loops, ceiling panels etc.), domestic hot water, or snow melting (keeping large areas clear of snow)

3.1 System overview

Uponor Smatrix Move PRO consists of a controller and a wide array of sensors. Together they control the supply temperature in each zone by managing the connected valve actuators and circulation pumps. The zones can be setup as follows.

Zone	Setup alternatives
1	Stand Alone Control Smatrix Base PRO
2	Stand Alone Control Smatrix Base PRO Domestic Hot Water
3	Stand Alone Control Smatrix Base PRO Meltaway

Stand Alone Control

If the zone is setup as **Stand Alone Control**, the controller operates without individual room control. The supply temperature setpoint is calculated using an outdoor sensor and a room temperature sensor (optional for heating only, mandatory together with humidity sensor S-157 for heating/cooling).

The zone can switch between heating and cooling using one of the following functions (set in the startup wizard):

- **Indoor and Outdoor** uses the indoor and outdoor temperatures to switch the zones between heating and cooling.
- **Supply Water Temp.** uses the supply water temperature to switch the zones between heating and cooling.
- **Contact Input** uses an external signal to switch the zones between heating and cooling.
- **Force Heating** sets the zones in forced heating.
- **Force Cooling** sets the zone in forced cooling.

The optional room temperature sensor is placed in a reference area and enables an indoor temperature setpoint parameter. It is used to keep the indoor temperature as close as possible to the indoor temperature setpoint.

A relative humidity sensor is used to avoid condensation problems while in cooling mode. An optional condensation sensor can be installed for added security.

Smatrix Base PRO

If the zone is setup as **Smatrix Base PRO**, individual room control in the zone is enabled via an integrated Uponor Smatrix Base PRO system. The supply temperature setpoint is calculated using sensor data and current mode from the Base PRO system.

Heating/cooling mode is set from the Smatrix Base PRO system.

The outdoor temperature sensor is connected to the Base PRO system via a thermostat, registered as a system device. The thermostat is preferably placed in a non-public area such as a technical room. The outdoor temperature sensor data will also be used by the other zones.

This requires the Move PRO controller to be connected to a Smatrix Base PRO bus.

A relative humidity sensor within the Smatrix Base PRO system is used to avoid condensation problems while in cooling mode.

Domestic Hot Water

If the zone is setup as **Domestic Hot Water**, hot water regulation is enabled in the zone. The supply temperature setpoint is set in the Move PRO controller display.



NOTE!

If the zone is setup as **Domestic Hot Water** without a return sensor, the zone will work with reduced functionality. Functions such as BoostPower and hot water recirculation requires a return sensor to work properly.

Meltaway

If the zone is setup as **Meltaway**, snow melting (keeping large areas clear of snow) is enabled in the zone. The supply temperature setpoint is calculated using an outdoor sensor, a ground temperature sensor, and a ground moisture sensor.

When to start or stop snow melting (status: Stop, Idle or Meltaway) is determined by using an outdoor temperature sensor and two Uponor Smatrix Move PRO Sensor Snow S-158 sensors. One of S-158 sensors is used for measuring the ground temperature and the other one is used for measuring the ground moisture level.

The return temperature sensor is used to calculate the difference between the supply and return temperature and trips an alarm if the difference is too high.

The primary return sensor is used to protect the heat source from too low return temperatures.

3.2 Example of a system

The illustration below shows a property divided into different zones. All zones are controlled by the Uponor Smatrix Move PRO.



NOTE!

This is an example. The Move PRO controller can be setup in a wide array of combinations.

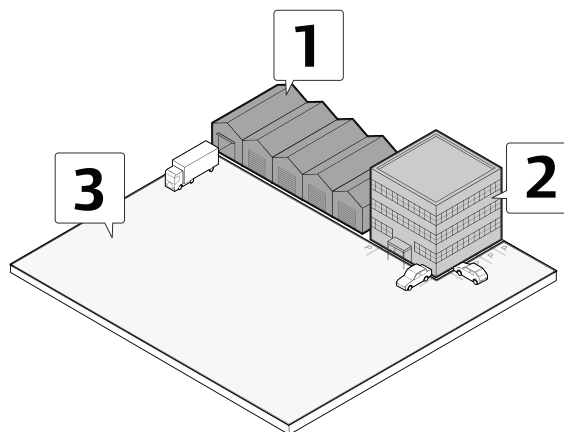

Zone	Description
1	The zone (underfloor heating in a warehouse) is setup as Stand Alone Control .
2	The zone (domestic hot water production) is setup as Domestic Hot Water .
3	The zone (keeping a parking lot and a large courtyard clear of snow) is setup as Meltaway .

3.3 Uponor Smatrix Move PRO components

CONTROLLER

The controller operates the valve actuators and circulation pumps, which in turn affect the supply water temperature to the zone.

The temperature in up to three zones can be regulated by the controller.

Uponor Smatrix Move PRO Controller X-159

Main characteristics:

- Integrated display with menu system.
- Control of supply temperature for up to three zones (up to three heating systems, one snow melting zone, and one domestic hot water zone).
- Heating/cooling curve (Stand Alone Control and Smatrix Base PRO zones only).
- Connection of maximum three actuators (one per zone).
- Connection of maximum three circulation pumps (one per zone).
- Pump exercise.
- Change supply temperature using customizable schedules (ECO mode).
- Initial setup done via startup wizard.
- BMS ready via Modbus and KNX interfaces.
- Integration with Uponor Smatrix Base PRO via system bus.

Options:

- Cabinet or wall mounted using a DIN rail (not supplied).

Components of the controller

The illustration below shows the controller and its components with the heating/cooling application package.

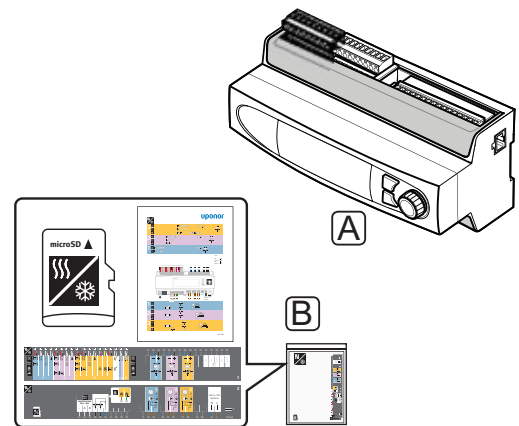

Item	Description
A	Uponor Smatrix Move PRO Controller X-159
B	Heating/cooling application package (microSD card, application diagram, connection stickers)

The box also contains a heating application package which is explained in another installation and operation manual.

ROOM SENSOR



NOTE!

The room sensor is affected by the temperature of the surrounding surfaces as well as the ambient air temperature.

Uponor Smatrix Move PRO Sensor Room S-155

The sensor is designed to measure the indoor reference temperature within the zone.

The sensor is only used in zones setup as **Stand Alone Control**.

Main characteristics:

- Sensor range is 0 – 60 °C.
- Prepared for wall or connection box mounting.

Components of the room sensor:

The illustration below shows the room sensor and its components.

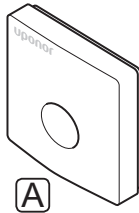

A

Item	Description
------	-------------

A	Smatrix Move PRO Sensor Room S-155
---	------------------------------------

HUMIDITY SENSOR

Uponor Smatrix Move PRO Sensor Humidity S-157

The sensor is designed to measure the relative humidity within the zone.

The sensor is only used in zones setup as **Stand Alone Control**.

Main characteristics:

- Sensor range is 0 – 100 %.
- Prepared for wall or connection box mounting.

Components of the humidity sensor:

The illustration below shows the humidity sensor and its components.

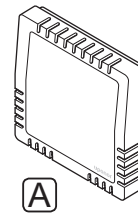

A

Item	Description
------	-------------

A	Smatrix Move PRO Sensor Humidity S-157
---	--

CONDENSATION SENSOR

Uponor Smatrix Condensation Set S-159

The sensor set is designed to detect and prevent condensation while the zone is in cooling mode.

The sensor is only used in zones setup as **Stand Alone Control** or **Smatrix Base PRO**.

Main characteristics:

- Sensor range: Condensation detected, Yes/No.
- Converter for cooling allowed signal.

Components of the condensation sensor:

The illustration below shows the condensation sensor and its components.

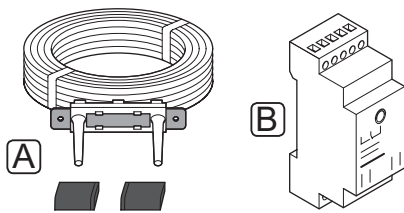

Item	Description
A	Condensation sensor
B	Converter

SNOW AND ICE SENSOR

Uponor Smatrix Move PRO Sensor Snow S-158

The sensor is designed to be embedded into outdoor surfaces to measure the ground temperature and moisture level.

The sensor is only used in zones setup as **Meltaway**. To ensure the snow melting function, two Uponor Smatrix Move PRO Sensor Snow S-158 and three supply/return sensors must be installed.

Main characteristics:

- Detects moisture.
- Detects temperature.
- Horizontal installation to ensure collection of draining melt water.

Options:

- The sensor can be used as either ground temperature sensor or ground moisture sensor. It cannot be used for both at once.

Components of the snow sensor:

The illustration below shows the snow sensor and its components.

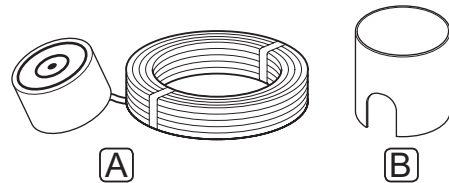

Item	Description
A	Smatrix Move PRO Sensor Snow & Ice S-158
B	Mounting socket

3.4 Accessories

Uponor offers a wide variety of accessories for use with the standard portfolio.

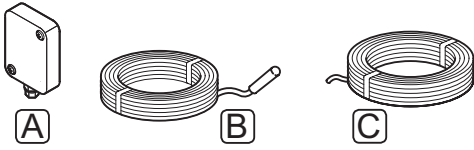

NOTE!

Some of these accessories may be included in the system.

Item	Component	Description
A	Uponor Smatrix Sensor Outdoor S-1XX (outdoor sensor S-1XX)	Outdoor sensor for use with system without a zone setup as Smatrix Base PRO.
B	Uponor Smatrix Move Sensor Supply/Return S-152 (supply/return sensor S-152)	Sensor that can be used as either a supply or return sensor.
C	Uponor Smatrix Bus cable A-145	Bus cable for use with integration of Uponor Smatrix Base PRO system

3.5 Functions

HEATING/COOLING CURVE

The Move PRO controller use a heating/cooling curve to calculate the supply temperature setpoint. This requires the zone to be setup as **Stand Alone Control** or **Smatrix Base PRO**.

The heating/cooling curve for the Uponor Smatrix Move PRO controller is shown in the diagram below. The diagram shows the calculated supply temperature, for each curve, at different outdoor temperatures. The controller uses the selected curve to operate the mixing valve, which in turn adjusts the supply temperature to the system.

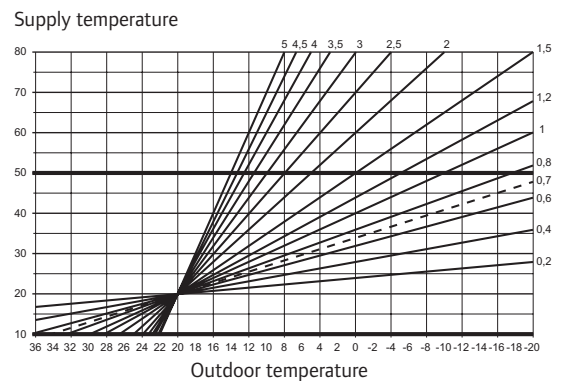

The choice of curve depends on a combination of different factors, such as how well insulated the house is, geographical location, type of heating/cooling system etc.

Example:

A poorly insulated house heated by a radiator system requires a higher curve value than an equivalent house with underfloor heating.

The curves in the diagram are also limited by maximum and minimum parameters set in the system (marked in the diagram with extra thick lines).

REAL TIME CLOCK

To facilitate accurate scheduling, the controller contains a real time clock. If an Uponor Smatrix Base PRO system is connected it will act as a time master, pushing the current time setting to the Move PRO controller.

COMFORT AND ECO MODES (SCHEDULING)

With the integrated timer in the controller, it is possible to change the temperature setpoint modes between two different temperatures. To utilise the Comfort and ECO modes in a zone, the zone must be setup as **Stand Alone Control** and using an room sensor. Available modes are **Comfort** and **ECO** (economy). *See example of Comfort and ECO mode below.*

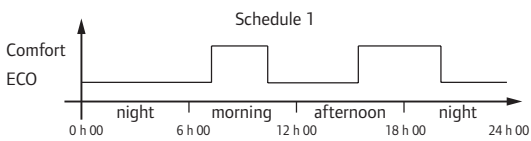

Other zones can, depending on system setup, simultaneously switch between Comfort and ECO mode according to their own programmed schedules.

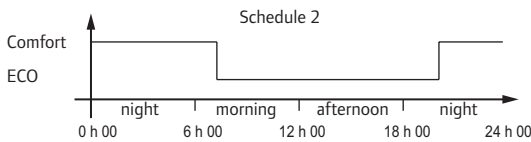

Even if programmed schedules exist in the system, some zones may still operate without any scheduling. These zones will operate in constant Comfort mode and is not affected by the programming of other zones.

SYSTEM INTEGRATION WITH BASE PRO SYSTEMS

The system can be integrated with an Uponor Smatrix Base PRO system to enable individual room control in the zone.

The outdoor temperature sensor is connected to the Base PRO system, and an additional outdoor temperature sensor connected to the Move PRO controller is not needed. The outdoor temperature sensor data will also be used by the other zones.

The integration is activated when a zone is setup as **Smatrix Base PRO** (requires that the wiring is done and that **Supply Water Controller** is activated in the **Integration** menu in the Base PRO interface) in the startup wizard on the Move PRO controller.

See section 5.10 Connect Uponor Smatrix Base PRO controller for more information.

See section 5.13 Startup wizard for more information.

See Uponor Smatrix Base PRO documentation for more information.

4 Install Uponor Smatrix Move PRO system

4.1 Installation procedure

UPONOR SMATRIX MOVE PRO

Uponor recommends following the process described below to guarantee the best possible installation results.

Stage	Procedure	Page
1	Prepare for installation	12
2	Install Uponor Smatrix Move PRO controller	23
3	Connect sensors to the controller	24
4	Connect mixing valve actuators to the controller	36
5	Connect diverting valve actuators to the controller	37
6	Connect circulation pumps to the controller	38
7	Connect Uponor Smatrix Base PRO controller	40
8	Connect the controller to AC power	41
9	Startup wizard	41
10	Finishing installation	50

4.2 Prepare for installation

Before starting the installation:

- Verify the contents of the package with the packing list.
See also section 3.3 Uponor Smatrix Move PRO components for identification of components.
- Study the wiring diagram in the end of this manual or on the controller.

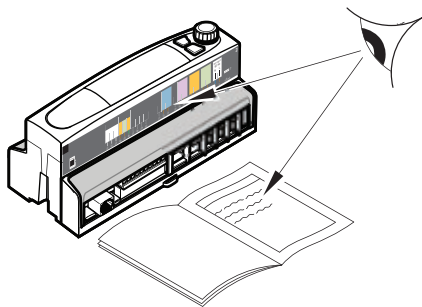

To determine where to best place the Uponor Smatrix Move PRO components, follow these guidelines:

- Ensure that the controller can be installed close to the valve actuators, if possible.
- Ensure that the controller can be mounted close to 230 V AC supply.
- Ensure that installed Uponor Smatrix Move PRO components are protected from running or dripping water, preferably in a cabinet.

4.3 Installation examples

The following sections describe a selection of installation examples with the Move PRO controller:

- Heating/cooling 2-pipe system in three different zones
- Heating/cooling 2-pipe system together with domestic hot water and meltaway production
- Heating/cooling 4-pipe system in three different zones
- Heating/cooling 4-pipe system together with domestic hot water production



WARNING!

Electrical installation and service behind secured 230 V AC covers must be carried out under the supervision of a qualified electrician.



NOTE!

These are outline diagrams. Real systems must be installed according to applicable norms and regulations.

HEATING/COOLING 2-PIPE SYSTEM IN THREE DIFFERENT ZONES

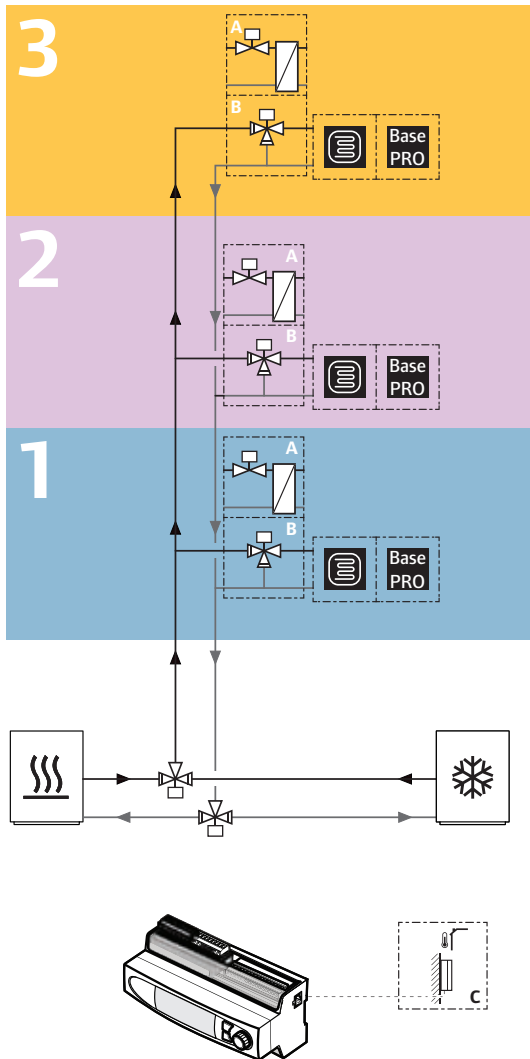

WARNING!

Electrical installation and service behind secured 230 V AC covers must be carried out under the supervision of a qualified electrician.



NOTE!

These are outline diagrams. Real systems must be installed according to applicable norms and regulations.

This connection example shows an Uponor Smatrix Move PRO Controller (with the heating/cooling application installed) regulating three different heating/cooling zones in a 2-pipe system.

- Zone 1 is setup as **Stand Alone Control** or **Smatrix Base PRO** for heating/cooling.
- Zone 2 is setup as **Stand Alone Control** or **Smatrix Base PRO** for heating/cooling.
- Zone 3 is setup as **Stand Alone Control** or **Smatrix Base PRO** for heating/cooling.

The supply is routed to the zones from the heating and cooling sources using two diverting valves. This enables switching between heating and cooling in all zones simultaneously.

The zone temperatures are regulated using a wide range of sensors, by using either a three-way mixing valve (B) or a two-way valve together with a heat exchanger (A), set temperatures (setpoints), and other zone specific parameter settings.

Example specific electrical connections

- The supply line diverting valve is connected to the terminals labelled **24** and **26**.
- The return line diverting valve is connected to the terminals labelled **25** and **26**.
- External signal for heating/cooling switch in all zones are connected to the terminals labelled **17** and **17L**.

See section 5 Install Uponor Smatrix Move PRO controller for more information.

See also the wiring diagram in the end of the manual.

Example specific system settings in startup wizard

Operation Mode: Standard

System Type: 2 Pipe

Indoor Cooling Only: No

Enable Zone # (# = 1, 2, and 3): Yes

Zone setup: Stand Alone Control, or Smatrix Base PRO

HC Switchover: Indoor and Outdoor, Supply Water Temp., Contact Input, Force Heating, or Force Cooling.

See section 4.3 Installation examples > Zone setup for more zone specific startup wizard settings.

See section 5.13 Startup wizard for more information.

See section 7.10 Settings for more information.

HEATING/COOLING 2-PIPE SYSTEM TOGETHER WITH DOMESTIC HOT WATER AND MELTAWAY PRODUCTION

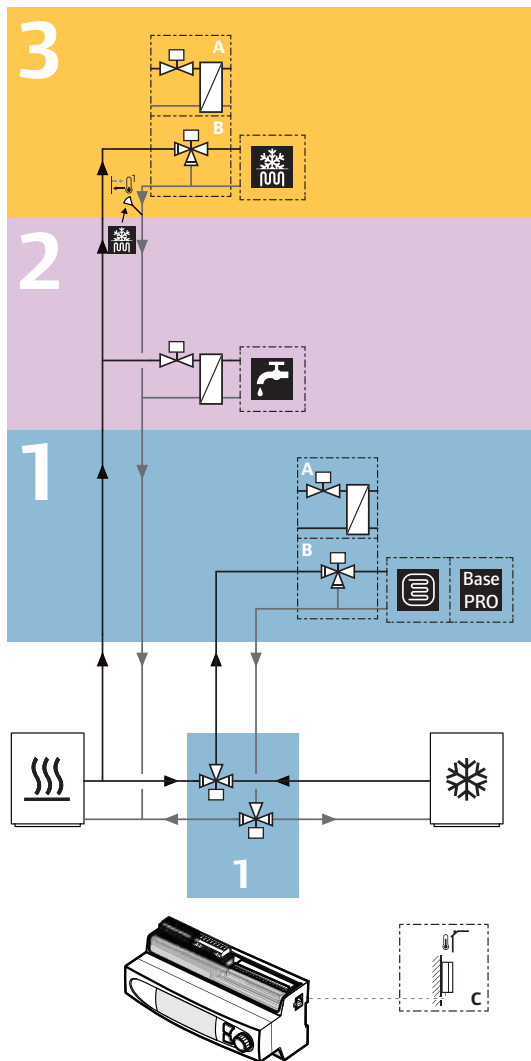

WARNING!

Electrical installation and service behind secured 230 V AC covers must be carried out under the supervision of a qualified electrician.



NOTE!

These are outline diagrams. Real systems must be installed according to applicable norms and regulations.

This connection example shows an Uponor Smatrix Move PRO Controller (with the heating/cooling application installed) regulating three different zones in a 2-pipe system.

- Zone 1 is setup as **Stand Alone Control** or **Smatrix Base PRO** for heating/cooling.
- Zone 2 is setup for **Domestic Hot Water** production.
- Zone 3 is setup for melting snow with **Meltaway**.

The supply is routed to zone 1 from the heating and cooling sources using two diverting valves, switching the zone between heating and cooling. Zones 2 and 3 are installed between the diverting valves and the heat source. This enables zones 2 and 3 to be operated independently from zone 1 (regardless if it is in heating or cooling mode).

The zone temperatures are regulated using a wide range of sensors, by using either a three-way mixing valve (B) or a two-way valve together with a heat exchanger (A), set temperatures (setpoints), and other zone specific parameter settings.



NOTE!

When using a 3-way mixing valve (option B) in a meltaway zone, a heat exchanger may be needed. This creates a secondary loop where water mixed with antifreeze additives circulate.

Example specific electrical connections

- The zone 1 supply and return line diverting valves are connected to the terminals labelled **24** and **26**.
Note! An external relay may be needed when connecting two diverting valves to the connection terminals.
- External signal for heating/cooling switch in zone 1 is connected to the terminals labelled **17** and **17L**.

See section 5 Install Uponor Smatrix Move PRO controller for more information.

See also the wiring diagram in the end of the manual.

Example specific system settings in startup wizard

Operation Mode: Standard

System Type: 2 Pipe

Indoor Cooling Only: No

Enable Zone # (# = 1, 2, and 3): Yes

Zone setup (zone 1): Stand Alone Control, or Smatrix Base PRO

Zone setup (zone 2): Domestic Hot Water

Zone setup (zone 3): Meltaway

HC Switchover: Indoor and Outdoor, Supply Water Temp., Contact Input, Force Heating, or Force Cooling.

See section 4.3 Installation examples > Zone setup for more zone specific startup wizard settings.

See section 5.13 Startup wizard for more information.

See section 7.10 Settings for more information.

HEATING/COOLING 4-PIPE SYSTEM IN THREE DIFFERENT ZONES

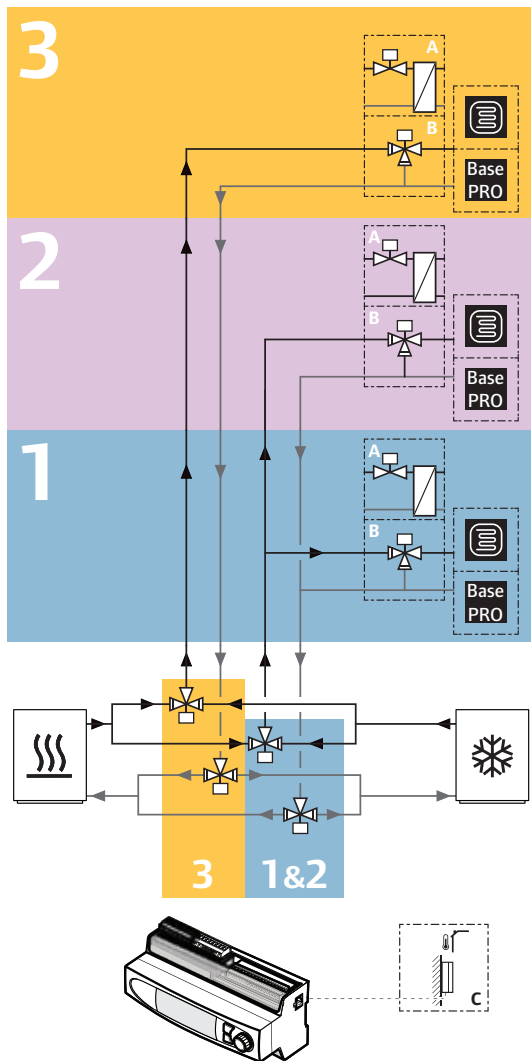

WARNING!

Electrical installation and service behind secured 230 V AC covers must be carried out under the supervision of a qualified electrician.



NOTE!

These are outline diagrams. Real systems must be installed according to applicable norms and regulations.

This connection example shows an Uponor Smatrix Move PRO Controller (with the heating/cooling application installed) regulating three different heating/cooling zones in a 4-pipe system.

- Zone 1 is setup as **Stand Alone Control** or **Smatrix Base PRO** for heating/cooling.
- Zone 2 is setup as **Stand Alone Control** or **Smatrix Base PRO** for heating/cooling.
- Zone 3 is setup as **Stand Alone Control** or **Smatrix Base PRO** for heating/cooling.

The supply is routed to the zones from the heating and cooling sources using four diverting valves. This enables zone 3 to be switched between heating and cooling independently from in zones 1 and 2 (which switch simultaneously).

The zone temperatures are regulated using a wide range of sensors, by using either a three-way mixing valve (B) or a two-way valve together with a heat exchanger (A), set temperatures (setpoints), and other zone specific parameter settings.

Example specific electrical connections

- The zone 1&2 supply and return line diverting valves are connected to the terminals labelled **24** and **26**.
Note! An external relay may be needed when connecting two diverting valves to the connection terminals.
- The zone 3 supply and return line diverting valves are connected to the terminals labelled **25** and **26**.
Note! An external relay may be needed when connecting two diverting valves to the connection terminals.
- External signal for heating/cooling switch in zone 1 and 2 are connected to the terminals labelled **17** and **17L**.
- External signal for heating/cooling switch in zone 3 is connected to the terminals labelled **18** and **18L**.

See section 5 Install Uponor Smatrix Move PRO controller for more information.

See also the wiring diagram in the end of the manual.

Example specific system settings in startup wizard

Operation Mode: Standard

System Type: 4 Pipe

Indoor Cooling Only: No

Enable Zone # (# = 1, 2, and 3): Yes

Zone setup: Stand Alone Control, or Smatrix Base PRO

Z1&2 Operation Mode: Heating And Cooling

Z3 Operation Mode: Heating And Cooling

See section 4.3 Installation examples > Zone setup for more zone specific startup wizard settings.

See section 5.13 Startup wizard for more information.

See section 7.10 Settings for more information.

HEATING/COOLING 4-PIPE SYSTEM TOGETHER WITH DOMESTIC HOT WATER PRODUCTION

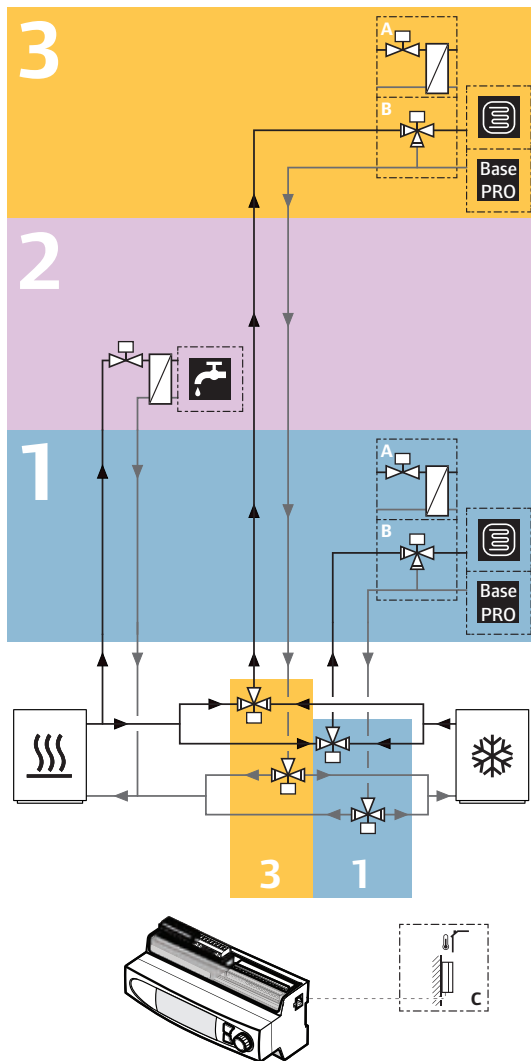

WARNING!

Electrical installation and service behind secured 230 V AC covers must be carried out under the supervision of a qualified electrician.



NOTE!

These are outline diagrams. Real systems must be installed according to applicable norms and regulations.

This connection example shows an Uponor Smatrix Move PRO Controller (with the heating/cooling application installed) regulating three different zones in a 4-pipe system.

- Zone 1 is setup as **Stand Alone Control** or **Smatrix Base PRO** for heating/cooling.
- Zone 2 is setup for **Domestic Hot Water** production.
- Zone 3 is setup as **Stand Alone Control** or **Smatrix Base PRO** for heating/cooling.

The supply is routed to zone 1 and 3 from the heating and cooling sources using four diverting valves, switching the zones between heating and cooling independently. Zone 2 is installed close to the heat source in permanent heating mode. This enables zones 2 to be operated independently from zones 1 and 3 (regardless if they are in heating or cooling mode).

The zone temperatures are regulated using a wide range of sensors, by using either a three-way mixing valve (B) or a two-way valve together with a heat exchanger (A), set temperatures (setpoints), and other zone specific parameter settings.

Example specific electrical connections

- The zone 1 supply and return line diverting valves are connected to the terminals labelled **24** and **26**.
Note! An external relay may be needed when connecting two diverting valves to the connection terminals.
- The zone 3 supply and return line diverting valves are connected to the terminals labelled **25** and **26**.
Note! An external relay may be needed when connecting two diverting valves to the connection terminals.
- External signal for heating/cooling switch in zone 1 is connected to the terminals labelled **17** and **17L**.
- External signal for heating/cooling switch in zone 3 is connected to the terminals labelled **18** and **18L**.

See section 5 Install Uponor Smatrix Move PRO controller for more information.

See also the wiring diagram in the end of the manual.

Example specific system settings in startup wizard

Operation Mode: Standard

System Type: 4 Pipe

Indoor Cooling Only: No

Enable Zone # (# = 1, 2, and 3): Yes

Zone setup (zone 1): Stand Alone Control, or Smatrix Base PRO

Z1&2 Operation Mode: Heating And Cooling

Zone setup (zone 2): Domestic Hot Water

Zone setup (zone 3): Stand Alone Control, or Smatrix Base PRO

Z3 Operation Mode: Heating And Cooling

See section 4.3 Installation examples > Zone setup for more zone specific startup wizard settings.

See section 5.13 Startup wizard for more information.

See section 7.10 Settings for more information.

ZONE SETUP

The zones can be setup as:

- **Stand Alone Control**
- **Smatrix Base PRO**
- **Domestic Hot Water**
- **Meltaway**

Stand Alone Control

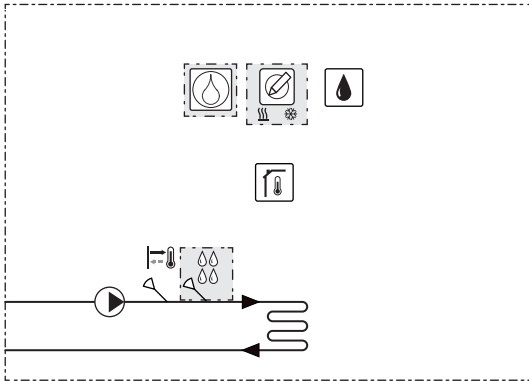

 If the zone (1 through 3) is setup as **Stand Alone Control**, basic control of the zone is enabled.

The following components are required or optional for heating/cooling operation in the zone (regulate the zone temperature using a mixing valve).

Required:

- Supply sensor S-152
- Room sensor S-155 (optional for heating only)
- Humidity sensor S-157 (optional for heating only)

Optional:

- Condensation sensor S-159
- Heating/Cooling Switch
- Dehumidifier

The optional dehumidifier can be connected to the controller instead of the circulation pump. If that option is chosen, then the circulation pump cannot be controlled by the Move PRO controller.

The zone can switch between heating and cooling using one of the following functions (set in the startup wizard):

- **Indoor and Outdoor** uses the indoor and outdoor temperatures to switch the zones between heating and cooling.
- **Supply Water Temp.** uses the supply water temperature to switch the zones between heating and cooling.
- **Contact Input** uses an external signal to switch the zones between heating and cooling.
- **Force Heating** sets the zones in forced heating.
- **Force Cooling** sets the zone in forced cooling.

The outdoor temperature sensor is not needed if the Move PRO controller is integrated with an Uponor Smatrix Base PRO system (with outdoor temperature sensor).

See section 5 Install Uponor Smatrix Move PRO controller for more information.

SYSTEM SETTINGS IN STARTUP WIZARD

Enable Zone # (# = 1, 2, or 3): Yes

Zone setup: Stand Alone Control

Z1&2 (or Z3) Operation Mode (4-pipe system only): Only Heating, Only Cooling, or Heating And Cooling

Heating Mode: Outdoor (outdoor temperature sensor only)
Outdoor + Indoor comp. (outdoor temperature sensor with optional room temperature sensor)

Z1&2 (or Z3) HC Switchover (4-pipe system only): Indoor and Outdoor, Supply Water Temp., Contact Input, Force Heating, or Force Cooling

Dehumidifier Control: Disable/Enable

Condensation Sensor: No/Yes

Other zone settings can be found in the menu system **Settings > Zone # Setting** (where # is the zone where **Stand Alone Control** is activated).

See section 5.13 Startup wizard for more information.

See section 7.10 Settings for more information.

Smatrx Base PRO

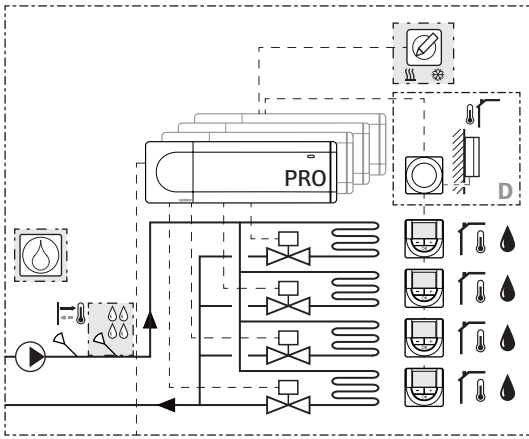

Base PRO If the zone (1 through 3) is setup as **Smatrx Base PRO**, individual room control in the zone is enabled.

The controller is connected to an Uponor Smatrx Base PRO system, via the Smatrx Base PRO bus, utilising its components to regulate the zone temperature.

The following components are required or optional for heating/cooling operation in the zone (regulate the zone temperature using a mixing valve).

Required:

- Supply sensor S-152
- Smatrx Base PRO system

Optional:

- Condensation sensor S-159
- Heating/Cooling Switch
- Dehumidifier

The outdoor temperature sensor is connected to the Base PRO system via a thermostat, registered as a system device. The thermostat is preferably placed in a non-public area such as a technical room.

Heating/cooling mode is set from the Smatrx Base PRO system.

The optional dehumidifier can be connected to the controller instead of the circulation pump. If that option is chosen, then the circulation pump cannot be controlled by the Move PRO controller.



CAUTION!

The integration is activated when a zone is setup as **Smatrx Base PRO** (requires that the wiring is done and that **Supply Water Controller** is activated in the **Integration** menu in the Base PRO interface) in the startup wizard on the Move PRO controller.

See section 5 *Install Uponor Smatrx Move PRO controller for more information.*

SYSTEM SETTINGS IN STARTUP WIZARD

Enable Zone # (# = 1, 2, or 3): Yes

Zone setup: Smatrx Base PRO

Z1&2 (or Z3) Operation Mode (4-pipe system only): Only Heating, Only Cooling, or Heating And Cooling

Heating Mode: Outdoor (outdoor temperature sensor only)
Outdoor + Indoor comp. (outdoor temperature sensor with optional room temperature sensor)

Smatrx Indoor Temperature: Worst Case (the measured worst case temperature in the zone), or Average (the calculated average temperature in the zone).

Z1&2 (or Z3) HC Switchover (4-pipe system only): Indoor and Outdoor, Supply Water Temp., Contact Input, Force Heating, or Force Cooling

Dehumidifier Control: Disable/Enable

Condensation Sensor: No/Yes

Assign Controller to zone: Assign connected Smatrx Base PRO controllers to zones.

Other zone settings can be found in the menu system **Settings > Zone # Setting** (where # is the zone where **Smatrx Base PRO** is activated).

See section 5.13 *Startup wizard for more information.*

See section 7.10 *Settings for more information.*

Domestic Hot Water

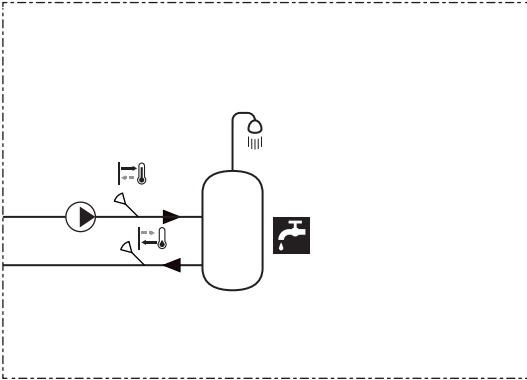

 If the zone is setup as **Domestic Hot Water**, hot water production is enabled in the zone.



CAUTION!

The Domestic Hot Water function requires a constant delivery of heating supply water, such as district heating.

The following components are required for regulating the hot water temperature in the zone (regulate the supply temperature using a mixing valve).

Required:

- Supply sensor S-152
- Return sensor S-152



NOTE!

If the zone is setup as **Domestic Hot Water** without a return sensor, the zone will work with reduced functionality. Functions such as BoostPower and hot water recirculation requires a return sensor to work properly.

See section 5 Install Uponor Smatrix Move PRO controller for more information.

SYSTEM SETTINGS IN STARTUP WIZARD

Enable Zone 2: Yes

Zone setup: Domestic Hot Water

Other zone settings can be found in the menu system **Settings > Zone # Setting** (where # is the zone where **Domestic Hot Water** is activated).

See section 5.13 Startup wizard for more information.

See section 7.10 Settings for more information.

Meltaway

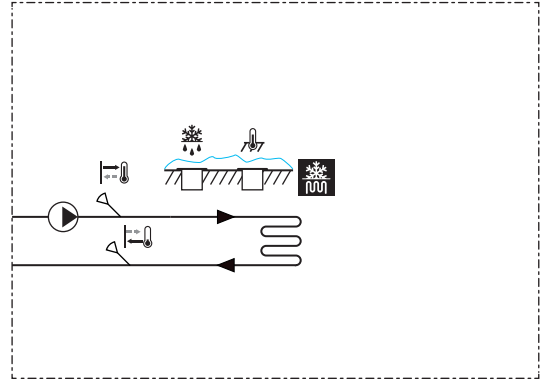

 If the zone is setup as **Meltaway**, hot water production for snow melting (keeping large areas clear of snow) is enabled in the zone.

The following components are required for snow melting hot water production in the zone (regulate the supply temperature using a mixing valve).

Required:

- Supply sensor S-152
- Return sensor S-152
- Primary return sensor S-152 (not shown in illustration)
- Snow sensor S-158 used as ground temperature sensor
- Snow sensor S-158 used as ground moisture sensor

The outdoor temperature sensor is not needed if the Move PRO controller is integrated with an Uponor Smatrix Base PRO system (with outdoor temperature sensor).

See section 5 Install Uponor Smatrix Move PRO controller for more information.

SYSTEM SETTINGS IN STARTUP WIZARD

Enable Zone 3: Yes

Zone setup: Meltaway

Other zone settings can be found in the menu system **Settings > Zone # Setting** (where # is the zone where **Melt away** is activated).



NOTE!

When using a 3-way mixing valve (option B) a heat exchanger may be needed, creating a secondary loop where water mixed with antifreeze additives circulate.

See section 5.13 Startup wizard for more information.

See section 7.10 Settings for more information.

5 Install Uponor Smatrix Move PRO controller

5.1 Placement of controller

Refer to the installation preparation guidelines (see section 4.2 *Prepare for installation*), and use the following guidelines when positioning the controller:

- Position the controller close to at least one of the actuators, preferably inside a cabinet. Check the position of the 230 V AC supply.
- Check that the terminal cover can be easily removed from the controller.
- Check that connectors and switches are easily accessible.

5.2 Select controller application

The controller is delivered with two packages containing applications for different use of the controller. The package contains a microSD card, electrical connection stickers, and an application diagram depicting installation examples.

Select the package containing the heating and cooling application and discard the other one.

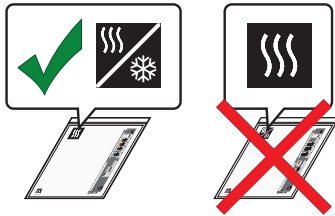

5.3 Attach stickers

Attach the stickers from the application package to the controller.

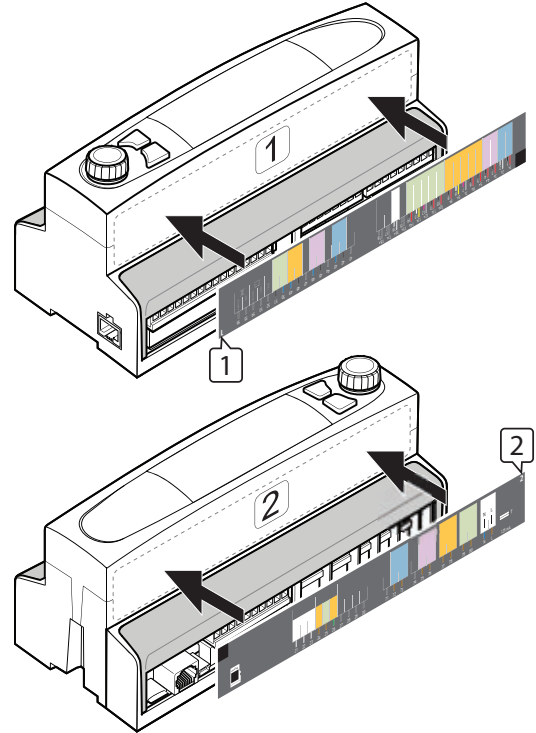

5.4 Insert microSD card

Insert the microSD card from the application package into the controller.

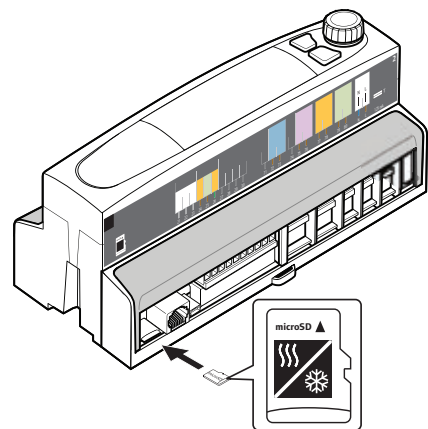

5.5 Attach controller to the wall

DIN RAIL

Attach the controller to a DIN rail in a cabinet (recommended), or to a DIN rail attached to a wall using screws and wall plugs.

The figure below shows how to attach the controller using a DIN rail.

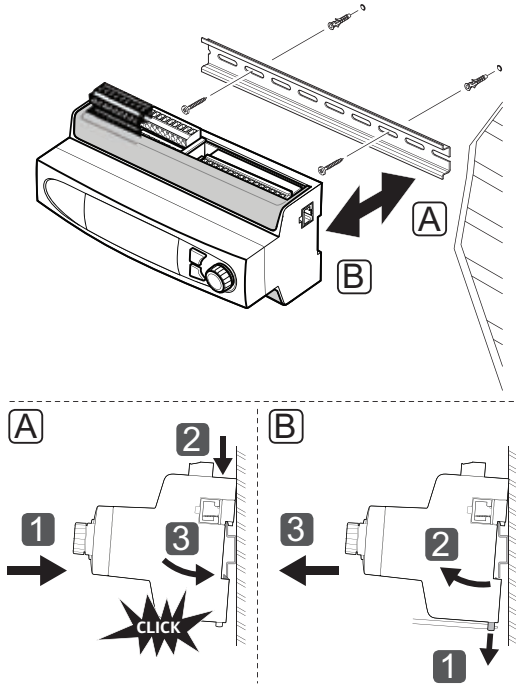

CAUTION!

Make sure the controller cannot slide off the DIN rail if mounting it in any other position than horizontal.

5.6 Terminal cover

The illustration below shows how to remove and re-attach the terminal cover.

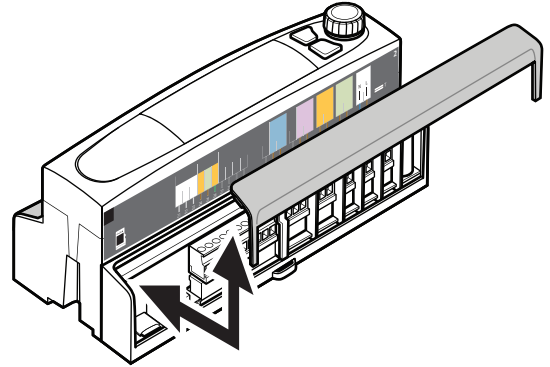

5.7 Connect sensors to controller

The following sensors can be connected to the system:

- Uponor Smatrix Outdoor S-1XX
- Uponor Smatrix Move Sensor Supply/Return S-152
- Uponor Smatrix Move PRO Sensor Room S-155
- Uponor Smatrix Move PRO Sensor Humidity S-157
- Uponor Smatrix Move PRO Sensor Snow S-158
- Uponor Smatrix Condensation Set S-159



WARNING!

Electrical installation and service behind secured 230 V AC covers must be carried out under the supervision of a qualified electrician.



CAUTION!

Make sure shielded cables are used when connecting sensors to the controller to prevent interference from power sources and cables.

OUTDOOR SENSOR

The outdoor sensor is mandatory and must always be installed. Either directly to the Move PRO controller or via an integrated Uponor Smatrix Base PRO controller. If a Base PRO controller is integrated to the system, it is a requirement to connect the outdoor temperature sensor to the Base PRO controller via a thermostat, registered as a system device. The thermostat is preferably placed in a non-public area such as a technical room.

Placement of outdoor sensor

Refer to the installation preparation guidelines (see *section 4.2 Prepare for installation*), and use the following guidelines when positioning the outdoor sensor:

1. Attach the outdoor sensor to the north side of the building where it is unlikely to be exposed to direct sunlight.
2. Ensure that the outdoor sensor is placed away from doors, windows, or air outlets.

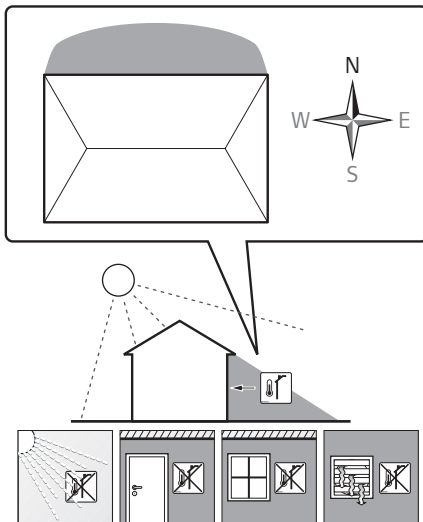

Connect outdoor sensor to controller

The illustration below shows the outdoor sensor connected to the controller.

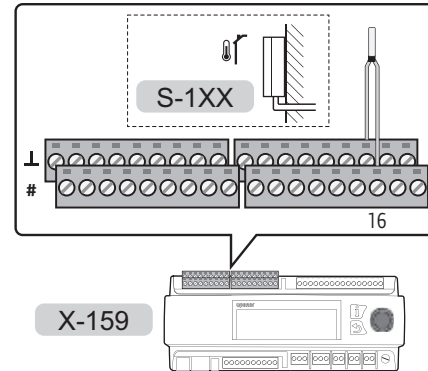

To connect an outdoor sensor to the controller:

1. Ensure that the power is disconnected from the controller.
2. Remove the terminal cover.
See section 5.6 Terminal cover for more information.
3. Study the wiring diagram to locate the connection terminal positions.
4. Connect the wires from the outdoor sensor to terminals 16 and 16L on the controller.
5. Tighten the screws fixing the wires to the connector.

SUPPLY SENSOR

The supply sensor needs to be installed in all zones.

Connect supply sensor to controller

The illustration below shows supply sensors connected to the controller.

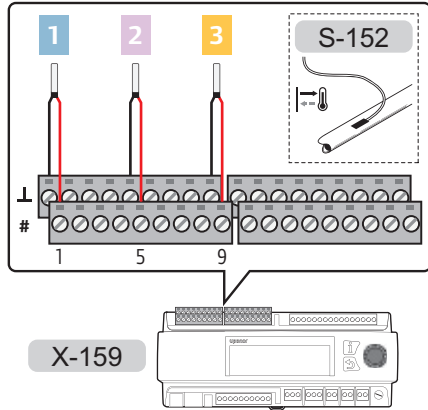

To connect a supply sensor to the controller:

1. Study the wiring diagram to locate the connection terminal positions.
2. Ensure that the power is disconnected from the controller.
3. Remove the terminal cover.
See section 5.6 Terminal cover for more information.
4. Connect the wires from the supply sensor to the controller.
 - ZONE 1: Terminals 1 and 1 \perp .
 - ZONE 2: Terminals 5 and 5 \perp .
 - ZONE 3: Terminals 9 and 9 \perp .
5. Tighten the screws fixing the wires to the connector.

RETURN SENSOR

The return sensor only needs to be installed in zones setup as **Meltaway** or **DHW** (domestic hot water).

Connect return sensor to controller

The illustration below shows return sensors connected to the controller.

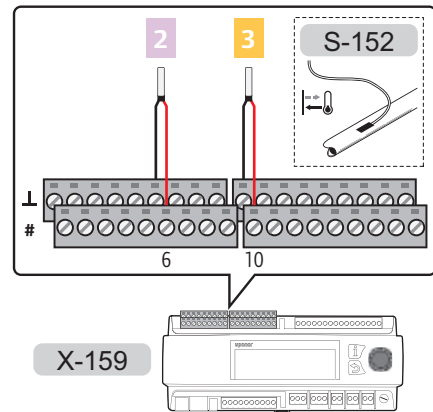

To connect a return sensor to the controller:

1. Study the wiring diagram to locate the connection terminal positions.
2. Ensure that the power is disconnected from the controller.
3. Remove the terminal cover.
See section 5.6 Terminal cover for more information.
4. Connect the wires from the return sensor to the controller.
 - ZONE 2: Terminals 6 and 6 \perp .
 - ZONE 3: Terminals 10 and 10 \perp .
5. Tighten the screws fixing the wires to the connector.

ROOM SENSOR

The room sensor only needs to be installed in zones setup as **Stand Alone**, with **Heating Mode** setup as **Outdoor + Indoor comp.**



NOTE!

The sensor is required in zones where heating/cooling (or cooling only) is enabled. Otherwise (heating only) it is only optional.

Placement of room sensor

Refer to the installation preparation guidelines (see section 4.2 *Prepare for installation*), and use the following guidelines when positioning the room sensors:

1. Select an indoor wall and a position 1.3 m to 1.5 m above the floor.
2. Ensure that the room sensor is away from direct solar radiation.
3. Ensure that the room sensor will not be heated through the wall by sunshine.
4. Ensure that the room sensor is away from any source of heat, for example television set, electronic equipment, fireplace, spotlights, and so on.
5. Ensure that the room sensor is away from any source of humidity and water splashes (IP20).

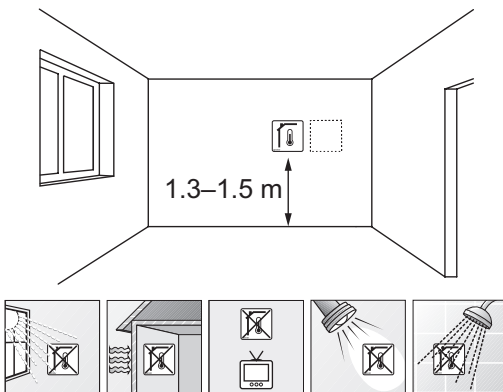

Label room sensor

Label the room sensors, where suitable, with the zone numbers they are to control, for example, #02, #03.

Attach room sensor to the wall

The illustration below shows room sensor mounting hole positions and how to attach it to the wall using screws and wall plugs.

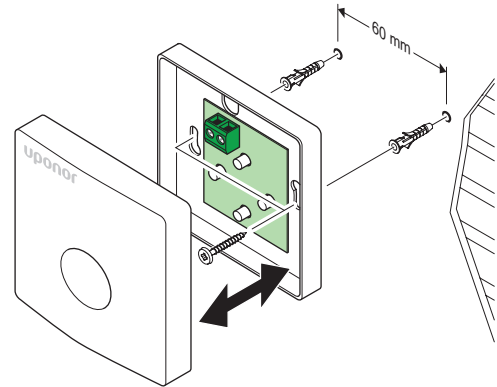

Connect room sensor to controller

The illustration below shows room sensors connected to the controller.

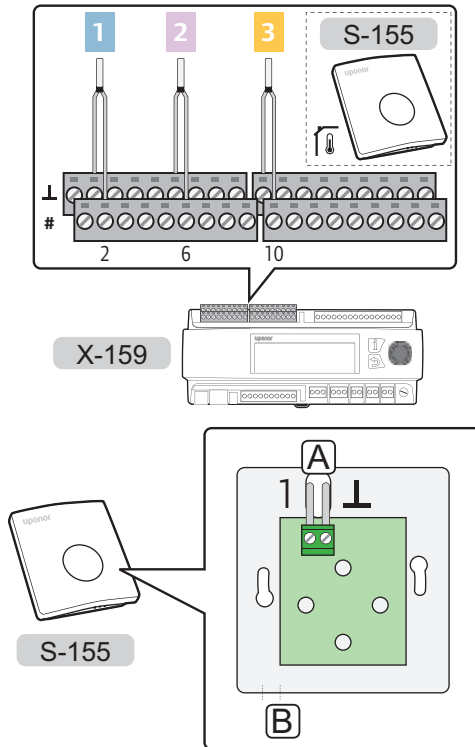

CAUTION!

Do not change the jumper setting, otherwise the function of the sensor will be compromised.

Default setting:

To connect a room sensor to the controller:

1. Study the wiring diagram to locate the connection terminal positions.
2. Ensure that the power is disconnected from the controller.
3. Remove the terminal cover.
See section 5.6 Terminal cover for more information.
4. Route the wires through points A or B.
5. Connect the wires from the room sensor to the controller.
 - ZONE 1: Terminals 2 and 2L.
 - ZONE 2: Terminals 6 and 6L.
 - ZONE 3: Terminals 10 and 10L.
6. Tighten the screws fixing the wires to the connector.

HUMIDITY SENSOR

The humidity sensor only needs to be installed in zones setup as **Stand Alone**.



NOTE!

The sensor is required in zones where heating/cooling (or cooling only) is enabled.

Placement of humidity sensor

Refer to the installation preparation guidelines (see section 4.2 *Prepare for installation*), and use the following guidelines when positioning the humidity sensors:

1. Select an indoor wall and a position 1.3 m to 1.5 m above the floor.
2. Ensure that the humidity sensor is away from direct solar radiation.
3. Ensure that the humidity sensor will not be heated through the wall by sunshine.
4. Ensure that the humidity sensor is away from any source of heat, for example television set, electronic equipment, fireplace, spotlights, and so on.
5. Ensure that the humidity sensor is away from any source of humidity and water splashes (IP30).

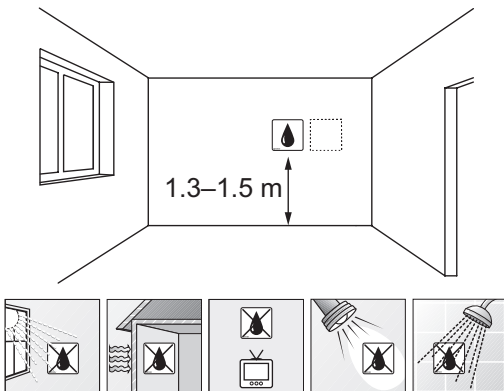

Label humidity sensor

Label the humidity sensors, where suitable, with the zone numbers they are to control, for example, #02, #03.

Attach humidity sensor to the wall

The illustration below shows humidity sensor mounting hole positions and how to attach it to the wall using screws and wall plugs.

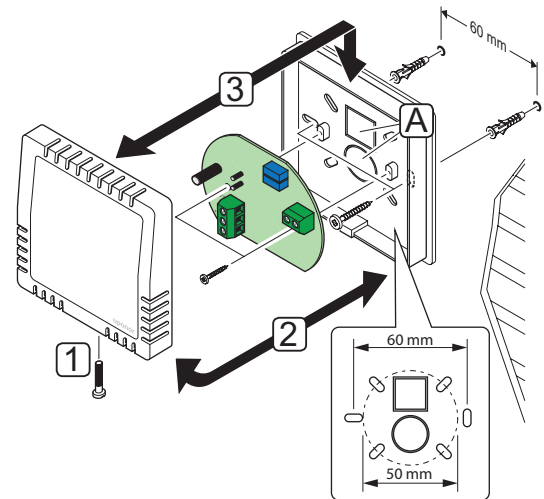

Connect humidity sensor to controller

The illustrations below shows humidity sensors connected to the controller.

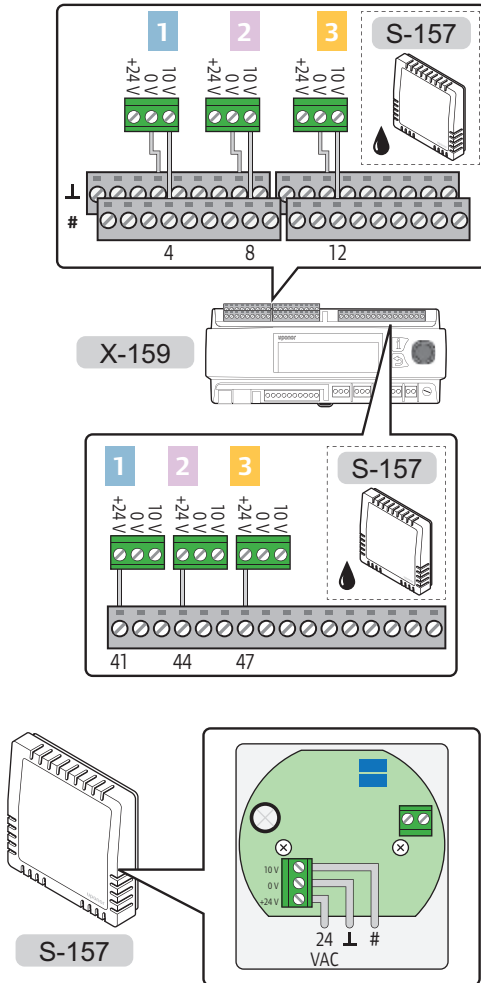

To connect a humidity sensor to the controller:

1. Study the wiring diagram to locate the connection terminal positions.
2. Ensure that the power is disconnected from the controller.
3. Remove the terminal cover.
See section 5.6 Terminal cover for more information.
4. Route the wires through one of the points A.
See Attach humidity sensor to the wall for more information.
5. Connect the wires from the humidity sensor to the controller.

ZONE 1:

- Control signal wires to terminals 4 and 4 \perp .
- 24 V AC wire to terminal 41 \perp

ZONE 2:

- Control signal wires to terminals 8 and 8 \perp .
- 24 V AC wire to terminal 44 \perp

ZONE 3:

- Control signal wires to terminals 12 and 12 \perp .
- 24 V AC wire to terminal 47 \perp

6. Tighten the screws fixing the wires to the connector.

SNOW SENSOR

The snow sensor only needs to be installed in zones setup as **Meltaway**.



CAUTION!

Two snow sensors are needed to guarantee the **Meltaway** function.

One of them is used as a ground temperature sensor and the other one as a ground moisture sensor.

When installing the snow and ice sensors in a zone a primary return sensor, and secondary supply and return temperature sensors are needed.

See section 5.7 Connect sensors to controller for more information.

Placement of the snow sensor sensors

The following requirements must be met when installing the snow sensor.

- The snow sensor must be installed within the area to be heated.
- The snow sensor must be installed levelled horizontally and embedded in a hard surface (such as concrete or asphalt).
- The snow sensor must not protude from the surface. It can be recessed a few millimeters into the surface to allow draining melt water to collect on the sensor surface. Not too deep though.
- The snow sensor must be installed in an open unsheltered position away from walls and exposed to the elements (eg. not close to walls, fan outlets, or other sources which can affect the sensors).
- If the snow sensor is to be used as a ground temperature sensor it must not be installed closer than 20 cm to the heating loop.
- If the snow sensor is to be used as a ground moisture sensor it must not be installed closer than 10 cm to the heating loop.
- If the ground is not horizontal, then the ground moisture sensor must be installer lower than the ground temperature sensor.
- Use a cable conduit with a diameter of up to 23 mm when routing the sensor cables.
- The sensor cable (supplied with 25 m) can be extended to up to 200 m using standard installation cable (6x1.5 mm²). The total resistance of the cable must be less than 10 ohm.

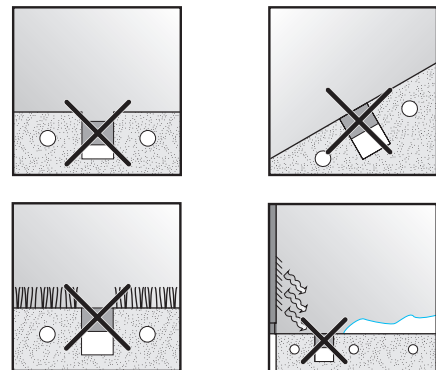
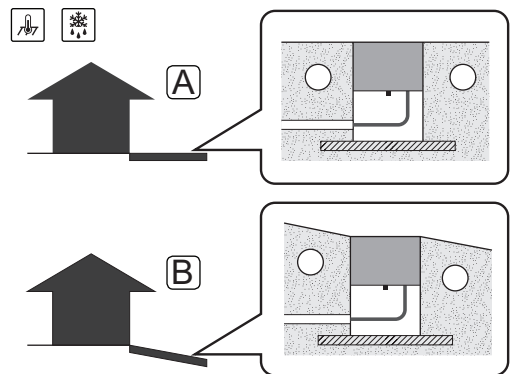
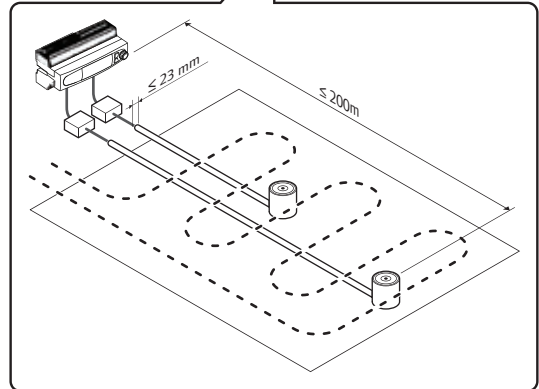
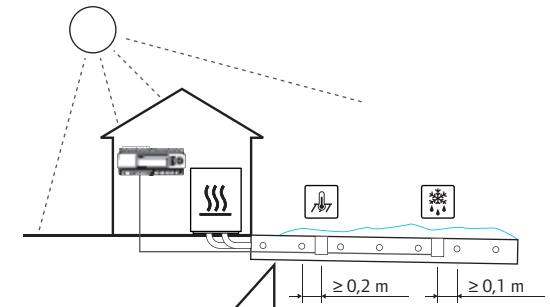

Install snow sensor into the ground surface

The following illustrations show how to install the snow sensor into the ground surface.

1. Create a notch for the cable conduit (maximum diameter of 23 mm). It is recommended to use a cable conduit equipped with a cord, in order to make it easier to pull the cable through when installed.

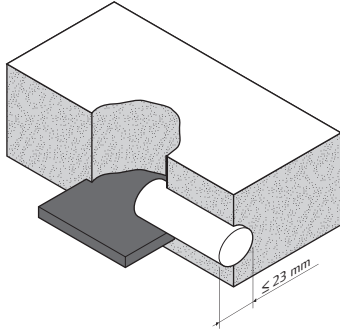

2. Insert the sensor tube in the hole where the sensor is to be installed. Make sure it is securely embedded in relation to the expected surface load.

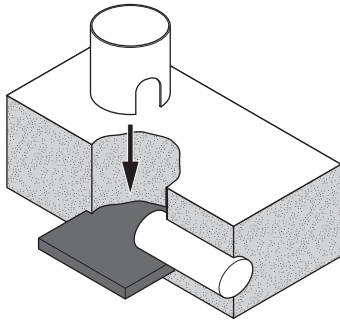

3. Insert the supplied wood plug into the sensor tube before applying the concrete/asphalt.

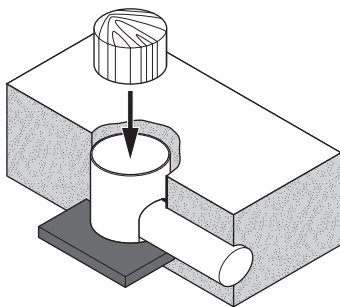

4. Apply the concrete/asphalt.

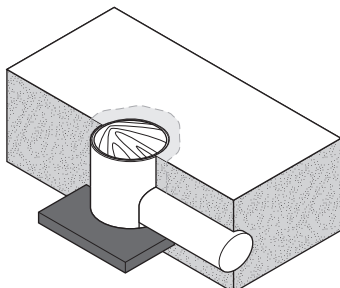

5. Remove the wood plug when the concrete/asphalt has cured.

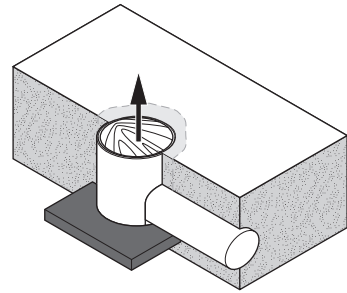

6. Ensure that the sensor tube is clean.

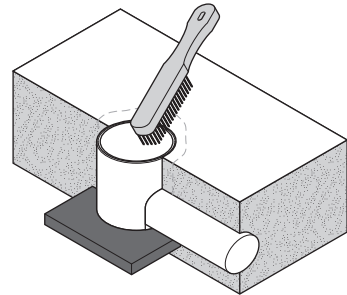

7. Insert the sensor cable and route it into the cable conduit. Ensure that the cable is not damaged on any sharp edges.

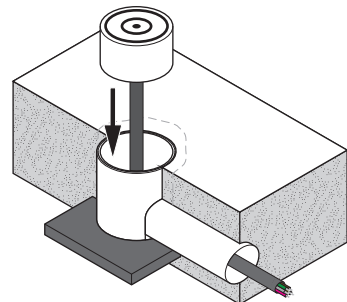

8. Place the snow sensor into the tube. Make sure that the cable easily fits in the hole in the bottom.

Secure the sensor (in the middle of the sensor) with the supplied screw.

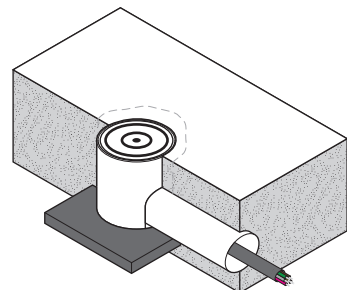

Connect snow sensor, used as ground temperature sensor, to controller

The illustration below shows the snow sensor, used as ground temperature sensor, connected to the controller.

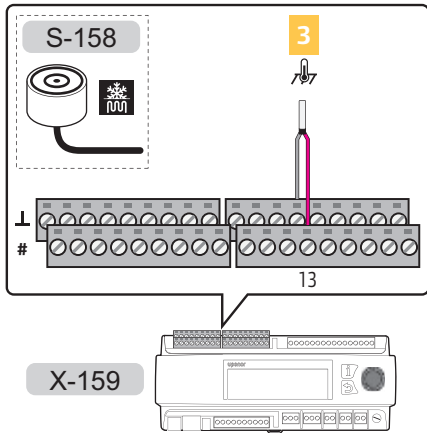

To connect a snow sensor to the controller:

1. Study the wiring diagram to locate the connection terminal positions.
2. Ensure that the power is disconnected from the controller.
3. Remove the terminal cover.
See section 5.6 Terminal cover for more information.
4. Connect the wires from the snow sensor to the controller.

ZONE 3:

- Pink wire to terminal 13
- Grey wire to terminal 13L

5. Tighten the screws fixing the wires to the connectors.

Connect snow sensor, used as ground moisture sensor, to controller.

The illustration below shows the snow sensor, used as ground moisture sensor, connected to the controller.

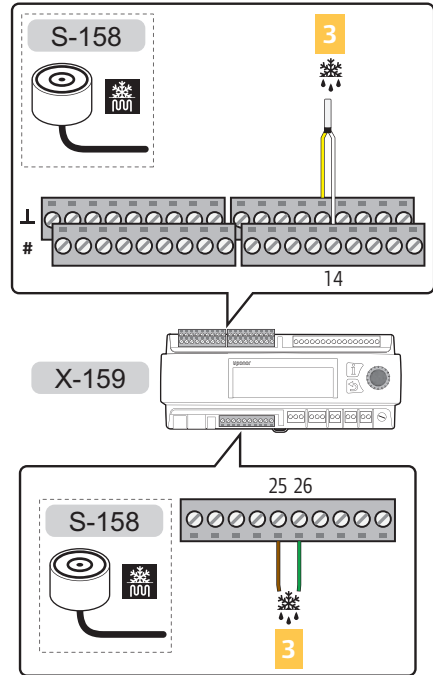

To connect a snow sensor to the controller:

1. Study the wiring diagram to locate the connection terminal positions.
2. Ensure that the power is disconnected from the controller.
3. Remove the terminal cover.
See section 5.6 Terminal cover for more information.
4. Connect the wires from the snow sensor to the controller.

ZONE 3:

- White wire to terminal 14
- Yellow wire to terminal 14L
- Brown wire to terminal 25
- Green wire to terminal 26

5. Tighten the screws fixing the wires to the connectors.

PRIMARY RETURN SENSOR

The primary return sensor may only need to be installed in zones setup as **Meltaway**.

Connect primary return sensor to controller

The illustration below shows a primary return sensor connected to the controller.

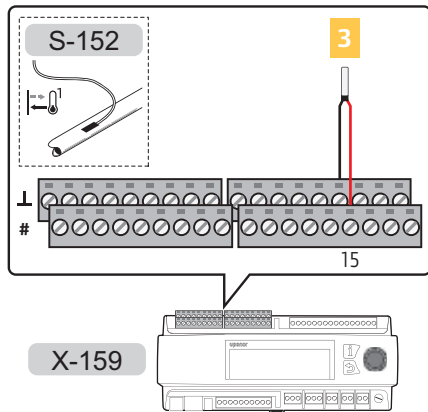

To connect a primary return sensor to the controller:

1. Study the wiring diagram to locate the connection terminal positions.
2. Ensure that the power is disconnected from the controller.
3. Remove the terminal cover.
See section 5.6 Terminal cover for more information.
4. Connect the wires from the primary return sensor to the controller.
 - ZONE 3: Terminals 15 and 15L.
5. Tighten the screws fixing the wires to the connector.

SECONDARY SUPPLY AND RETURN SENSORS

The secondary supply or return sensor is connected as a standard supply or return sensor.

See section 5.7 Connect sensors to controller > Supply sensor for more information.

See section 5.7 Connect sensors to controller > Return sensor for more information.

CONDENSATION SENSOR KIT

The condensation sensor kit is optional for zones setup as **Stand Alone** or **Smatrix Base PRO**.

The condensation kit consist of a relative humidity sensor connected to a converter, which in turn is connected to the Move PRO controller. The sensor measures the relative humidity of the air flowing through its capillary tubes and translates it to electrical resistance. If the electrical resistance drops to about 8 MΩ (about 80-85 % relative humidity) the converter opens the signal to the Move PRO controller, which shuts of cooling. When the electrical resistance reaches approximately 16 MΩ the signal to the controller is closed and cooling is allowed again.

Cut capillary tubes on the condensation sensor

The illustration below shows the capillary tubes being cut to allow air flow through the sensor (to measure relative humidity).

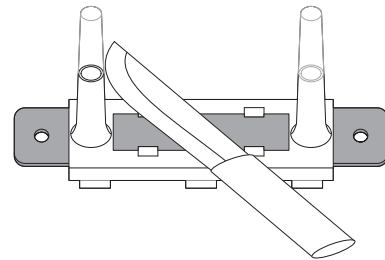

Attach condensation sensor to the supply pipe

The illustration below shows the condensation sensor attached to the supply pipe using cable straps.

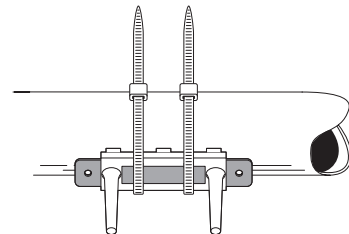

Attach converter to DIN rail

The illustration below shows the attached to a DIN-rail.

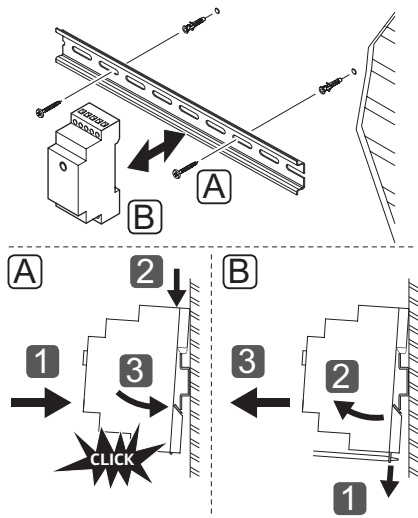

Connect condensation sensor kit to controller

The illustration below shows a condensation sensor kit connected to the controller.

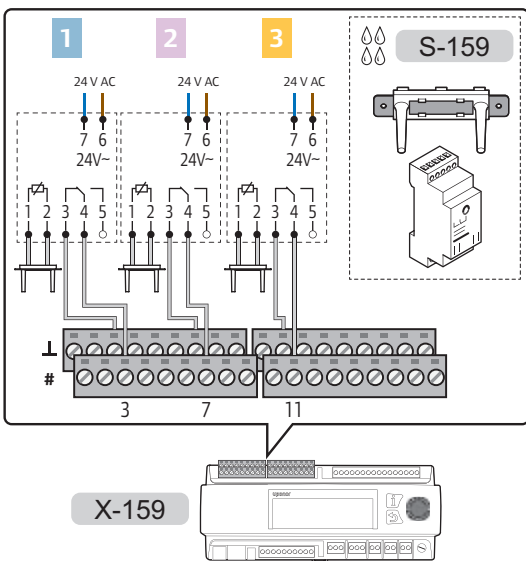

CAUTION!

Maximum length of the sensor cable is 10 meters.

To connect a condensation sensor kit to the controller:

1. Study the wiring diagram to locate the connection terminal positions.
2. Ensure that the power is disconnected from the controller.
3. Remove the terminal cover.
See section 5.6 Terminal cover for more information.
4. Connect the condensation sensor to terminals 1 and 2 on the the converter.

Note! Use one condensation sensor kit (converter and sensor) per zone where it is to be used.

5. Connect the the converter to the controller.

ZONE 1:

- Converter terminal 3 to controller terminal 3.
- Converter terminal 4 to controller terminal 3_L

ZONE 2:

- Converter terminal 3 to controller terminal 7.
- Converter terminal 4 to controller terminal 7_L

ZONE 3:

- Converter terminal 3 to controller terminal 11.
- Converter terminal 4 to controller terminal 11_L

6. Connect the converter to 24 V AC.

- L to converter terminal 6.
- N to converter terminal 7.

Note! Use one condensation sensor kit (converter and sensor) per zone where it is to be used.

7. Tighten the screws fixing the wires to the connectors.

5.8 Connect external signal for heating/cooling switch to the controller

The external signal for heating/cooling switch is optional for zones setup as **Stand Alone**.

A total of two external signals for heating/cooling switch can be connected to the controller. One external signal controls zone 1 and/or zone 2, depending on zone setup. The other one controls zone 3.

The illustration below shows external signals for heating/cooling switch connected to the controller.

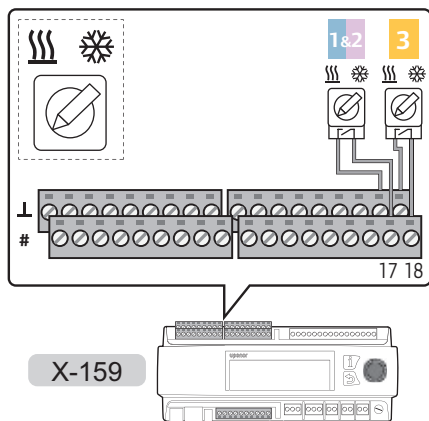

To connect an external signal for heating/cooling switch to the controller:

1. Ensure that the power is disconnected from the controller.
2. Remove the terminal cover.
See section 5.6 Terminal cover for more information.
3. Study the wiring diagram to locate the connection terminal positions.
4. Connect the wires for heating/cooling switch to the controller.
 - ZONE 1&2: Terminals 17 and 17 \perp .
 - ZONE 3: Terminals 18 and 18 \perp .
5. Tighten the screws fixing the wires to the connector.

5.9 Connect mixing valve actuators to the controller

The controller can control up to 3 different zones.

The illustration below shows actuators connected to the controller.

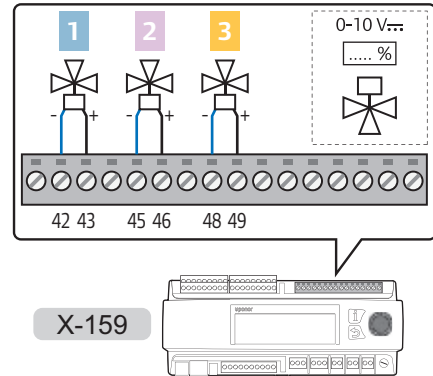

WARNING!

Electrical installation and service behind secured 230 V AC covers must be carried out under the supervision of a qualified electrician.



NOTE!

Only the control signals from the valve actuators are connected to the Move PRO controller. Power must be obtained from an external source.

To connect valve actuators to the controller:

1. Ensure that the power is disconnected from both the controller and the actuator.
2. Remove the terminal cover.
See section 5.6 Terminal cover for more information.
3. Study the wiring diagram to locate the connection terminal positions.
4. Connect the wires from the actuator to the controller.

ZONE 1:

- 0...10 V wire to terminal 43.
- Ground wire (\perp) to terminal 42.

ZONE 2:

- 0...10 V wire to terminal 46.
- Ground wire (\perp) to terminal 45.

ZONE 3:

- 0...10 V wire to terminal 49.
- Ground wire (\perp) to terminal 48.

5. Tighten the screws fixing the wires to the connector.

5.10 Connect diverting valve actuators to the controller

The controller can control up to 3 different zones.

The illustration below shows actuators in a 2 pipe setup connected to the controller.

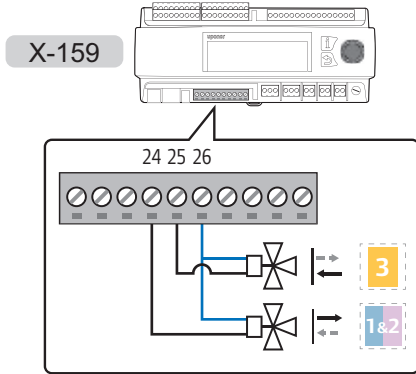

CAUTION!

An external relay may be needed when connecting two diverting valves to the connection terminals (24 V AC output).

The illustration below shows diverting valves in a 4 pipe setup connected to the controller using external relays.

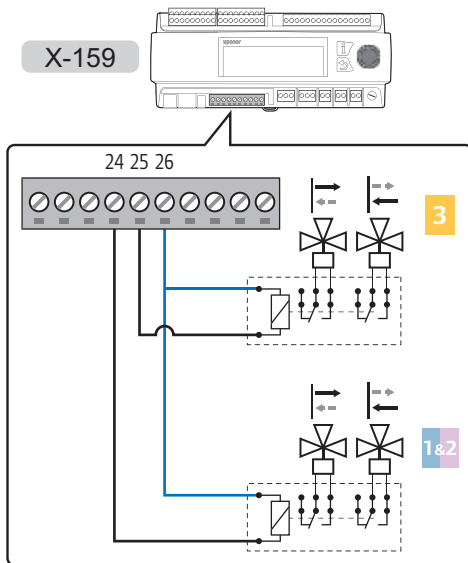

WARNING!

Electrical installation and service behind secured 230 V AC covers must be carried out under the supervision of a qualified electrician.



NOTE!

Only the control signals from the valve actuators are connected to the Move PRO controller. Power must be obtained from an external source.

To connect valve actuators or external relays to the controller:

1. Ensure that the power is disconnected from both the controller and the actuator.
2. Remove the terminal cover.
See section 5.6 Terminal cover for more information.
3. Study the wiring diagram to locate the connection terminal positions.
4. Connect the wires from the actuator (or relay) to the controller.

ZONE 1&2 (4 pipe)/Supply line (2 pipe):

- 24 V AC wire to terminal 24.
- Ground wire (⊥) to terminal 26.

ZONE 3 (4 pipe)/Return line (2 pipe):

- 24 V AC wire to terminal 25.
- Ground wire (⊥) to terminal 26.

5. Tighten the screws fixing the wires to the connector.

5.11 Connect circulation pumps to the controller

The controller can control either a circulation pump or a dehumidifier in up to 3 different zones.

The illustration below shows circulation pumps connected to the controller.

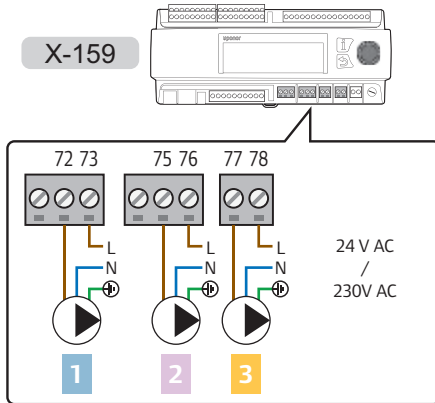

CAUTION!

The terminals are limited to 1A. An external relay might be needed.



NOTE!

The zone 3 connection terminal is using TRIAC for power control.

The illustration below shows a circulation pump connected to the controller using external relays.

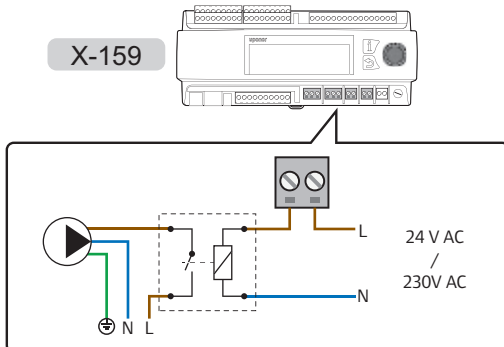

WARNING!

Electrical installation and service behind secured 230 V AC covers must be carried out under the supervision of a qualified electrician.

To connect circulation pumps or external relays to the controller:

1. Ensure that the power is disconnected from the controller.
2. Remove the terminal cover.
See section 5.6 Terminal cover for more information.
3. Study the wiring diagram to locate the connection terminal positions.
4. Connect power (max 230VAC) to the circulation pumps/external relays via connection terminals on the controller.

Caution! The terminals are limited to 1A. An external relay might be needed.

ZONE 1:

- Power (L) from the circulation pump to terminal 72.
- External 24 or 230 V A C (L) to terminal 73.

ZONE 2:

- Power (L) from the circulation pump to terminal 75.
- External 24 or 230 VAC (L) to terminal 76.

ZONE 3:

- Power (L) from the circulation pump to terminal 77.
- External 24 or 230 VAC (L) to terminal 78.

5. Connect the common wire (N) from the circulation pumps to external connection.
6. Tighten the screws fixing the wires to the connector.

5.12 Connect a dehumidifier to the controller

The controller can control either a dehumidifier or a circulation pump in up to 3 different zones.

The illustration below shows dehumidifiers connected to the controller.

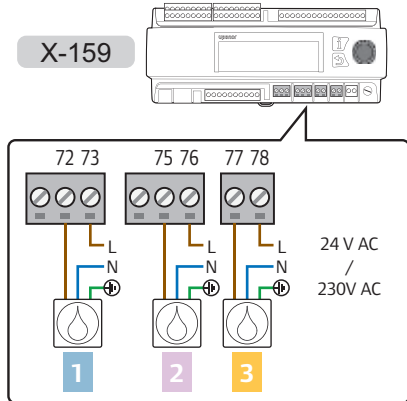

CAUTION!
The terminals are limited to 1A. An external relay might be needed.

NOTE!
The zone 3 connection terminal is using TRIAC for power control.

The illustration below shows dehumidifiers connected to the controller via dry contact.

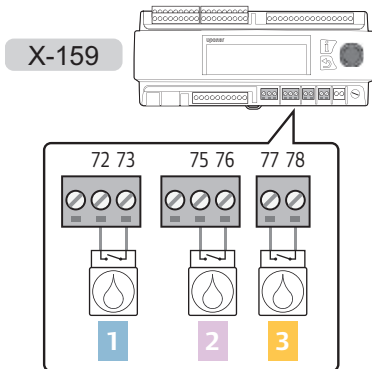

The illustration below shows a dehumidifier connected to the controller using external relays.

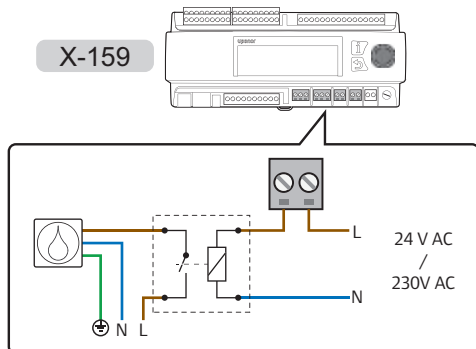

STOP WARNING!

Electrical installation and service behind secured 230 V AC covers must be carried out under the supervision of a qualified electrician.

To connect dehumidifiers or external relays to the controller:

1. Ensure that the power is disconnected from the controller.
2. Remove the terminal cover.
See section 5.6 Terminal cover for more information.
3. Study the wiring diagram to locate the connection terminal positions.
4. Connect the dehumidifier to the controller.
 - 4.1 Connect power (max 230VAC) to the dehumidifiers/external relays via connection terminals on the controller.

Caution! The terminals are limited to 1A. An external relay might be needed.

ZONE 1:

 - Power (L) from the dehumidifier to terminal 72.
 - External 24 or 230 VAC (L) to terminal 73.

ZONE 2:

 - Power (L) from the dehumidifier to terminal 75.
 - External 24 or 230 VAC (L) to terminal 76.

ZONE 3:

 - Power (L) from the dehumidifier to terminal 77.
 - External 24 or 230 VAC (L) to terminal 78.
 - 4.2 Connect the dry contact in the dehumidifiers to the connection terminals on the controller.

ZONE 1:

 - Dry contact to terminals 72-73.

ZONE 2:

 - Dry contact to terminals 75-76.

ZONE 3:

 - Dry contact to terminals 77-78.
5. Connect the common wire (N) from the dehumidifiers to external connection.
6. Tighten the screws fixing the wires to the connector.

5.13 Connect Uponor Smatrix Base PRO controller

The controller can be connected to an Uponor Smatrix Base PRO system bus for integration with Base PRO controllers and thermostats.

The illustration below shows the Uponor Smatrix Base Pro system bus connected to the controller.

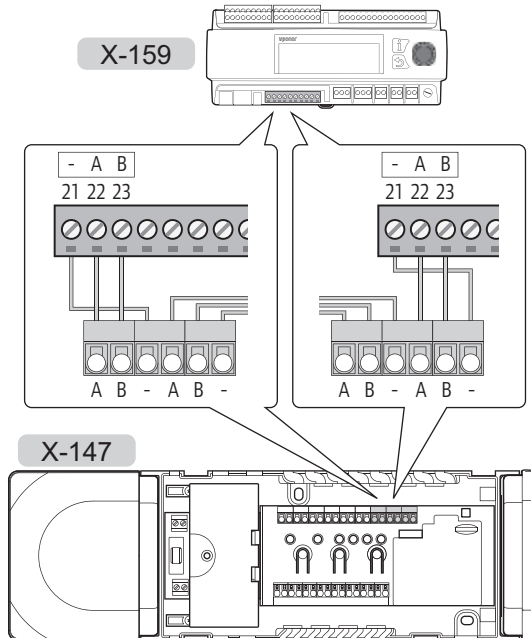

WARNING!

Electrical installation and service behind secured 230 V AC covers must be carried out under the supervision of a qualified electrician.

To connect an Uponor Smatrix Base PRO system bus to the controller:

1. Ensure that the power is disconnected from all controllers.
2. Remove the terminal cover on the Move PRO controller.
See section 5.6 Terminal cover for more information.
3. Remove the cover on (one of) the Base PRO controllers.
See Uponor Smatrix Base PRO documentation for more information.

4. Study the wiring diagrams of both controllers to locate the connection terminal positions.
5. Connect the wires from the Base PRO controller to the Move PRO controller.

Uponor Smatrix Base PRO:

- Communication wire to system bus terminal A, B and -.

Uponor Smatrix Move PRO:

- Communication wire to system bus terminal 21 (-), 22 (A) and 23 (B).

6. Tighten the screws fixing the wires to the connector.

Enable the Move PRO controller in the Smatrix Base PRO interface I-147:

7. Go to the **Integration** menu (**Main menu > Integration**).
8. Press **Supply Water Controller: Disable**.
9. Press **Enable** to activate communication between the interface and the Move PRO controller.
10. Assign controllers at the end of the Startup Wizard in the Move PRO controller. Connected Smatrix Base PRO controllers will be shown in a list automatically.
See section 5.14 Startup wizard for more information.

5.14 Connect Modbus RTU interface

The controller can be connected and integrated to a building management system (BMS) through a Modbus-RTU interface over RS-232.

See separate documentation for more information about BMS integration.

5.15 Connect the controller to AC power

The illustration below shows the the controller connected to AC power.

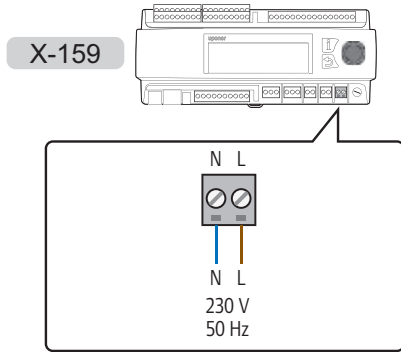

WARNING! Electrical installation and service behind secured 230 V AC covers must be carried out under the supervision of a qualified electrician.

To connect the controller to AC power:

1. Check that all wiring is complete and correct:
 - Sensors
 - Valve actuators
 - Circulation pump
2. Connect the 230 V AC power cable to connection terminals N (blue) and L (brown).
3. Ensure that all terminal covers are attached correctly.
4. Connect the power cable to a 230 V AC wall socket, or if required by local regulations, to a junction box.

5.16 Alternate power inputs

The controller has connection terminals for alternate power inputs (connection terminals 52 – 56).

CAUTION! Do not use these input terminals, unless instructed to by Uponor technical support.

CAUTION! Set the jumper to **OFF** if using alternate power inputs.

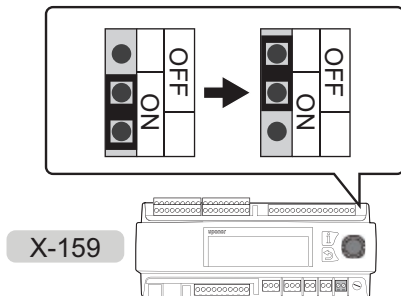

5.17 Startup wizard

The controller initiates a startup wizard the first time it is started, or after a factory reset. This wizard is designed to configure the controller zones. Further settings can be done in the **Settings** menu.

It can also be started manually through the menu system, **Settings > Installer Settings > Restart wizard**.

NOTE! The display on the controller can start flashing when powered on. This is completely normal and the regular operation will continue shortly after.

CAUTION! At least one zone must be enabled when setting up the controller. Otherwise a configuration error will appear and the startup wizard is restarted.

NAVIGATING THE STARTUP WIZARD

Select/change

Turn the control wheel to select an option, or to change a parameter setting.

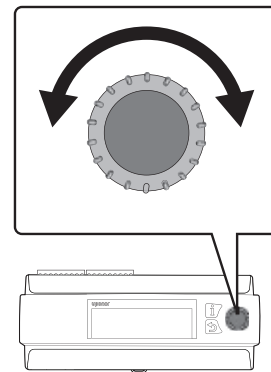

Confirm

Press the control wheel to confirm a selection or parameter setting.

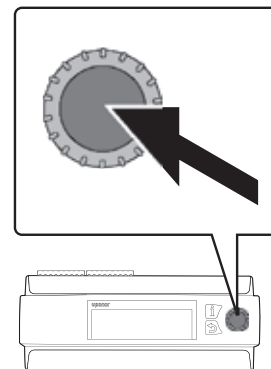

1. SET LANGUAGE

Select the language which is to be used in the controllers menu system.

Language

- English
- Deutsch
- Espanol
- Swedish

2. SET THE TIME

Set the time of the system, starting with the hours.

Time

Enter the hours

12:34

hh:mm

Time

Enter the minutes

12:34

hh:mm

3. SET THE DATE

Set the date of the system, starting with the day.

Date

Enter the day

Tue 01.06.2016

Date

Enter the month

Tue 01.06.2016

Date

Enter the year

Tue 01.06.2016

4. SELECT OPERATION MODE

Select operation mode of the controller.

- Select **Standard** to continue setting up the controller for heating/cooling operation.
- Select **Pre Heating** to enable pre heating operation mode in the controller.

See section 5.17 Pre heating concrete slab (DIN 1264-4) for more information.

Operation Mode

- Standard
- Pre Heating

5. SYSTEM TYPE

Select system type, **2 Pipe** or **4 Pipe** hydraulic delivery system.

- **2 Pipe** means that all zones setup as Stand Alone Control or Smatrix Base PRO switches between heating and cooling at the same time.
- **4 Pipe** means that zones 1 and 2, and zone 3, switches between heating and cooling independently from each other.

Individual zones can still be setup as **Domestic Hot Water** or **Meltaway** if needed. Those zones will not be affected by this setting, as long as their supply pipes are placed before the heating/cooling diverting valves..

System Type

- 2 Pipe
- 4 Pipe

6. INDOOR COOLING ONLY

This setting is only shown if 2 Pipe is selected in the System Type menu.

Select **Yes** to enable cooling only (**No** enables heating/cooling) in the system.

Individual zones can still be setup as **Domestic Hot Water** or **Meltaway** if needed. Those zones will not be affected by this setting, as long as their supply pipes are placed before the heating/cooling diverting valves..

Indoor Cooling Only

- No
- Yes

7. ENABLE ZONE 1

7.1 Select **Yes** to enable zone 1 in the controller.

Enable Zone 1

No

Yes

7.2 Select the setup of the zone. **Stand Alone Control** only uses the sensors and components connected to the controller. **Smatrix Base PRO** uses a connected Uponor Smatrix Base PRO system.

Zone Setup

Stand Alone Control

Smatrix Base PRO

7.3 Select operation mode of the zone. The setting affects both zone 1 and 2, if the system is installed and setup accordingly.

This setting is only shown if 4 pipe is selected in the System Type menu.

Z1&2 Operation Mode

Only Heating

Only Cooling

Heating And Cooling

7.4 Select heating mode. **Outdoor** only uses an outdoor sensor, and **Outdoor + Indoor comp.** also uses a room sensor to calculate the supply temperature. The sensor/sensors are connected to either the Move PRO controller (**Stand Alone Control**) or to a connected Base PRO controller (**Smatrix Base PRO**).

See section 5.7 Connect sensors to controller > Outdoor sensor for more information

Heating Mode

Outdoor

Outdoor + Indoor comp.

7.5 Select which indoor temperature data in the Smatrix Base PRO system to use when calculating the supply temperature.

- **Worst Case** uses the room temperature from the room (only rooms with a heating demand) with the highest setpoint value (heating mode), or with the highest measured relative humidity value (cooling), in the zone.
- **Average** calculates, only in heating mode, the average from all connected room thermostats in the zone (selected in the Smatrix Base PRO interface I-147).

This setting is only shown if Smatrix Base PRO is selected in the Zone Setup menu, and if Outdoor + Indoor comp. is selected in Heating Mode.

Smatrix Indoor Temperature

Worst Case

Average

7.6 Select how to switch zone 1 and 2 between heating and cooling.

- **Indoor and Outdoor** uses the indoor and outdoor temperatures to switch the zone between heating and cooling.
- **Supply Water Temp.** uses the supply water temperature to switch the zone between heating and cooling.
- **Contact Input** uses an external signal to switch the zone between heating and cooling.
- **Force Heating** sets the zone in forced heating.
- **Force Cooling** sets the zone in forced cooling.

This setting is only shown if 4 pipe is selected in the System Type menu, and if Z1&2 Operation Mode is set to Heating And Cooling.

Z1&2 HC Switchover

Indoor and Outdoor

Supply Water Temp.

Contact Input

Force Heating

- 7.7 Set minimum and maximum allowed supply temperature when in heating and/or cooling mode.

The heating minimum and maximum supply temperatures can only be set if heating is allowed in the zone.

The cooling minimum and maximum supply temperatures can only be set if cooling is allowed in the zone.

Heating Min. Supply Temp.	15°C	min: 5 max: 70
Heating Max. Supply Temp.	70°C	min: 15 max: 90
Cooling Min. Supply Temp.	8.0°C	min: 5.0 max: 25.0
Cooling Max. Supply Temp.	25.0°C	min: 8.0 max: 40.0

- 7.8 Select **Enable** to enable dehumidifier control in the zone.

Note! Enabling dehumidifier disables circulation pump control in the zone (except for zones setup as **Smatrix Base PRO** where the circulation pump is controlled by the Base PRO controller).

Dehumidifier Control	<input checked="" type="radio"/> Disable	<input type="radio"/> Enable
----------------------	--	------------------------------

- 7.9 Select **Yes** if a condensation sensor is installed in the zone and connected to the controller.

Condensation Sensor	<input checked="" type="radio"/> No	<input type="radio"/> Yes
---------------------	-------------------------------------	---------------------------

8. ENABLE ZONE 2

- 8.1 Select **Yes** to enable zone 2 in the controller.

Enable Zone 2	<input checked="" type="radio"/> No	<input type="radio"/> Yes
---------------	-------------------------------------	---------------------------

- 8.2 Select the setup of the zone. **Stand Alone Control** only uses the sensors and components connected to the controller. **Smatrix Base PRO** uses a connected Uponor Smatrix Base PRO system. **Domestic Hot Water** (DHW) regulates the supply temperature for DHW in the zone.

Zone Setup	<input checked="" type="radio"/> Stand Alone Control	<input type="radio"/> Smatrix Base PRO	<input type="radio"/> Domestic Hot Water
------------	--	--	--

- 8.3 Select operation mode of the zone. The setting affects both zone 1 and 2, if the system is installed and setup accordingly.

This setting is only shown if 4 pipe is selected in the System Type menu, zone 1 is not enabled, and Zone Setup is set to Stand Alone Control or Smatrix Base PRO.

Z1&2 Operation Mode	<input checked="" type="radio"/> Only Heating	<input type="radio"/> Only Cooling	<input type="radio"/> Heating And Cooling
---------------------	---	------------------------------------	---

- 8.4 Select heating mode. **Outdoor** only uses an outdoor sensor, and **Outdoor + Indoor comp.** also uses a room sensor to calculate the supply temperature. The sensor/sensors are connected to either the Move PRO controller (**Stand Alone Control**) or to a connected Base PRO controller (**Smatrix Base PRO**).

See section 5.7 Connect sensors to controller > Outdoor sensor for more information

This setting is not shown if Domestic Hot Water is selected in the Zone Setup menu.

Heating Mode	<input checked="" type="radio"/> Outdoor	<input type="radio"/> Outdoor + Indoor comp.
--------------	--	--

8.5 Select which indoor temperature data in the Smatrix Base PRO system to use when calculating the supply temperature.

- **Worst Case** uses the room temperature from the room (only rooms with a heating demand) with the highest setpoint value (heating mode), or with the highest measured relative humidity value (cooling), in the zone.
- **Average** calculates, only in heating mode, the average from all connected room thermostats in the zone (selected in the Smatrix Base PRO interface I-147).

This setting is only shown if Smatrix Base PRO is selected in the Zone Setup menu, and if Outdoor + Indoor comp. is selected in Heating Mode.

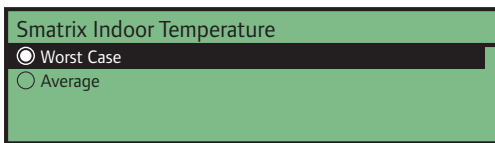

8.6 Select how to switch zone 1 and 2 between heating and cooling.

- **Indoor and Outdoor** uses the indoor and outdoor temperatures to switch the zone between heating and cooling.
- **Supply Water Temp.** uses the supply water temperature to switch the zone between heating and cooling.
- **Contact Input** uses an external signal to switch the zone between heating and cooling.
- **Force Heating** sets the zone in forced heating.
- **Force Cooling** sets the zone in forced cooling.

This setting is only shown if 4 pipe is selected in the System Type menu, zone 1 is not enabled, Zone Setup is set to Stand Alone Control or Smatrix Base PRO, and Z1&2 Operation Mode is set to Heating And Cooling.

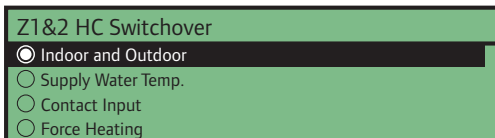

8.7 Set minimum and maximum allowed supply temperature when in heating and/or cooling mode.

The heating minimum and maximum supply temperatures can only be set if heating is allowed in the zone.

The cooling minimum and maximum supply temperatures can only be set if cooling is allowed in the zone.

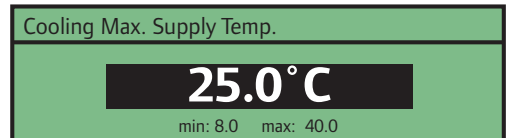
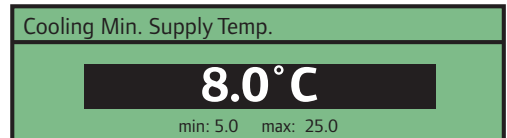
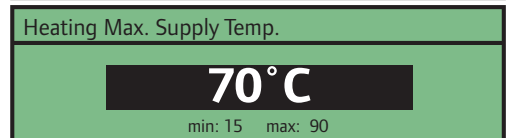
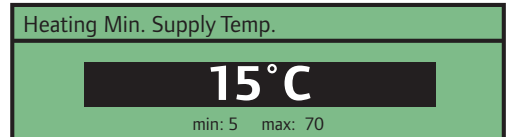

8.7 Select **Enable** to enable dehumidifier control in the zone.

Note! Enabling dehumidifier disables circulation pump control in the zone (except for zones setup as **Smatrix Base PRO** where the circulation pump is controlled by the Base PRO controller).

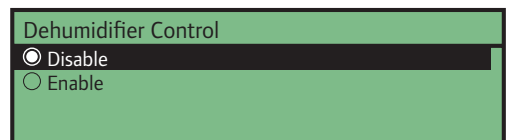

8.8 Select **Yes** if a condensation sensor is installed in the zone and connected to the controller.

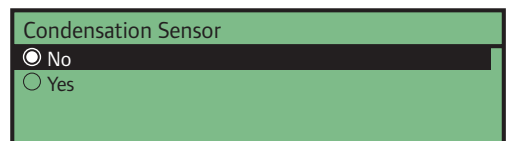

9. ENABLE ZONE 3

9.1 Select **Yes** to enable zone 3 in the controller.

Enable Zone 3

No

Yes

9.2 Select the setup of the zone. **Stand Alone Control** only uses the sensors and components connected to the controller. **Smatrix Base PRO** uses a connected Uponor Smatrix Base PRO system. **Meltaway** uses snow sensors to keep large areas clear of snow.

Zone Setup

Stand Alone Control

Smatrix Base PRO

Meltaway

9.3 Select operation mode of the zone. The setting affects zone 3, if the system is installed and setup accordingly.

This setting is only shown if 4 pipe is selected in the System Type menu and if Zone Setup is set to Stand Alone Control or Smatrix Base PRO.

Z3 Operation Mode

Only Heating

Only Cooling

Heating And Cooling

9.4 Select heating mode. **Outdoor** only uses an outdoor sensor, and **Outdoor + Indoor comp.** also uses a room sensor to calculate the supply temperature. The sensor/sensors are connected to either the Move PRO controller (**Stand Alone Control**) or to a connected Base PRO controller (**Smatrix Base PRO**).

See section 5.7 Connect sensors to controller > Outdoor sensor for more information

This setting is not shown if Meltaway is selected in the Zone Setup menu.

Heating Mode

Outdoor

Outdoor + Indoor comp.

9.5 Select which indoor temperature data in the Smatrix Base PRO system to use when calculating the supply temperature.

- **Worst Case** uses the room temperature from the room (only rooms with a heating demand) with the highest setpoint value (heating mode), or with the highest measured relative humidity value (cooling), in the zone.
- **Average** calculates, only in heating mode, the average from all connected room thermostats in the zone (selected in the Smatrix Base PRO interface I-147).

This setting is only shown if Smatrix Base PRO is selected in the Zone Setup menu, and if Outdoor + Indoor comp. is selected in Heating Mode.

Smatrix Indoor Temperature

Worst Case

Average

9.6 Select how to switch zone 3 between heating and cooling.

- **Indoor and Outdoor** uses the indoor and outdoor temperatures to switch the zone between heating and cooling.
- **Supply Water Temp.** uses the supply water temperature to switch the zone between heating and cooling.
- **Contact Input** uses an external signal to switch the zone between heating and cooling.
- **Force Heating** sets the zone in forced heating.
- **Force Cooling** sets the zone in forced cooling.

This setting is only shown if Z3 Operation Mode is set to Heating And Cooling, and if the zone is setup as Stand Alone Controller or Smatrix Base PRO.

HC Switchover

Indoor and Outdoor

Supply Water Temp.

Contact Input

Force Heating

9.7 Set minimum and maximum allowed supply temperature when in heating and/or cooling mode.

The heating minimum and maximum supply temperatures can only be set if heating is allowed in the zone.

The cooling minimum and maximum supply temperatures can only be set if cooling is allowed in the zone.

Heating Min. Supply Temp.	15°C min: 5 max: 70
Heating Max. Supply Temp.	70°C min: 15 max: 90
Cooling Min. Supply Temp.	8.0°C min: 5.0 max: 25.0
Cooling Max. Supply Temp.	25.0°C min: 8.0 max: 40.0

9.8 Select **Enable** to enable dehumidifier control in the zone.

Note! Enabling dehumidifier disables circulation pump control in the zone (except for zones setup as **Smatrix Base PRO** where the circulation pump is controlled by the Base PRO controller).

Dehumidifier Control	<input checked="" type="radio"/> Disable <input type="radio"/> Enable
----------------------	--

9.9 Select **Yes** if a condensation sensor is installed in the zone and connected to the controller.

Condensation Sensor	<input checked="" type="radio"/> No <input type="radio"/> Yes
---------------------	--

10 HC SWITCHOVER

Select how to switch the zones in a 2 pipe system between heating and cooling (requires **Indoor Cooling Only** to be set to **No**). This only affects zones set to **Stand Alone Control**. If one of the zones is set to **Smatrix Base PRO** this setting will not be shown, as the heating/cooling switching will be performed by the Base PRO system.

- **Indoor and Outdoor** uses the indoor and outdoor temperatures to switch the zones between heating and cooling.
- **Supply Water Temp.** uses the supply water temperature to switch the zones between heating and cooling.
- **Contact Input** uses an external signal to switch the zones between heating and cooling.
- **Force Heating** sets the zones in forced heating.
- **Force Cooling** sets the zone in forced cooling.

HC Switchover	<input checked="" type="radio"/> Indoor and Outdoor <input type="radio"/> Supply Water Temp. <input type="radio"/> Contact Input <input type="radio"/> Force Heating
---------------	---

11. ASSIGN CONTROLLER TO ZONE

If the Move PRO controller is connected to a Smatrix Base PRO system, the connected controllers can be assigned to the different zones. This requires the zone setup to be set to Smatrix Base PRO.



NOTE!

The controllers in the Base PRO system must be registered to the Smatrix Base PRO interface I-147. Otherwise they will not appear in this menu.

This setting is only shown if Smatrix Base PRO is selected in the Zone Setup menu.

Select a connected Smatrix Base PRO controller and assign it to a zone.

Assign Controller to zone	Controller 1 Zone 1 > Controller 2 Zone 2 >
Controller 1	<input checked="" type="radio"/> Not Assigned <input type="radio"/> Zone 1 <input type="radio"/> Zone 2 <input type="radio"/> Zone 3

5.18 Pre heating concrete slab (DIN 1264-4)

The controller can be setup to pre heat a concrete slab before a property is finished.

Pre heating is run in three different phases.

Phase 1: The supply temperature setpoint is set to 25 °C for 3 days (can be set in the **Settings** menu).

Phase 2: The supply temperature setpoint is set to maximum allowed calculated setpoint for 4 days (can be set in the **Settings** menu).

Phase 3: The controller enters **Standby** mode until the startup wizard is restarted (**Settings > Installer Settings > Restart wizard**). Frost protection is active during this final phase.



CAUTION!

In order to setup the controller zones, after pre heating, the startup wizard must be restarted.

To setup the controller for pre heating:

1. SET LANGUAGE

Select the language which is to be used in the controllers menu system.

2. SET THE TIME

Set the time of the system, starting with the hours.

3. SET THE DATE

Set the date of the system, starting with the day.

4. SELECT OPERATION MODE

Select **Pre Heating** to enable pre heating operation mode in the controller.

5. ENABLE PRE HEATING ZONE 1

5.1 Select **Enable** to enable pre heating zone 1 in the controller.

5.2 Set a maximum allowed calculated supply setpoint.

6. ENABLE PRE HEATING ZONE 2

6.1 Select **Enable** to enable pre heating zone 2 in the controller.

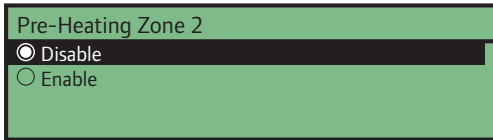

Pre-Heating Zone 2

Disable

Enable

6.2 Set a maximum allowed calculated supply setpoint.

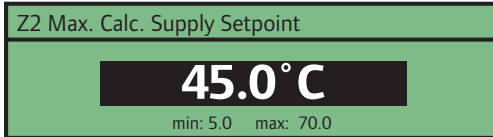

Z2 Max. Calc. Supply Setpoint

45.0°C

min: 5.0 max: 70.0

7. ENABLE PRE HEATING ZONE 3

7.1 Select **Enable** to enable pre heating zone 3 in the controller.

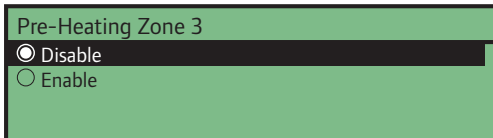

Pre-Heating Zone 3

Disable

Enable

7.2 Set a maximum allowed calculated supply setpoint.

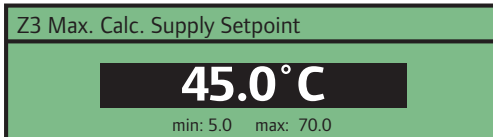

Z3 Max. Calc. Supply Setpoint

45.0°C

min: 5.0 max: 70.0

6 Finishing installation

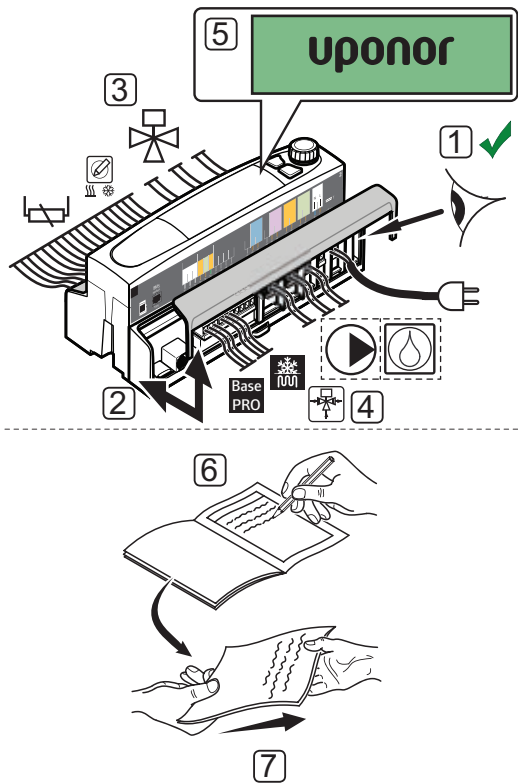

Make a complete check up of the installation:

1. Make sure all wiring is done correctly and that the wires are thoroughly fastened.
2. Re-attach the terminal covers to the controller.
3. Check the mixing valves.

Increase the setpoints in each zone to make sure the mixing valves are opening correctly.

4. Check the diverting valves.

Go to **Settings > Zone # Settings (# = 1 – 3) > Manual Operation > Mixing valve** and make sure the diverting valves are operating correctly.

5. Set system parameters in the controller to the defined operating settings.
6. Print and fill in the "Installation report" located at the end of the manual.
7. Give the manual and all information about the system to the user.

7 Operate the Uponor Smatrix Move PRO controller

7.1 Principle of operation

The controller calculates the supply temperature for up to 3 different zones using a wide array of sensors. The calculated supply temperature is compared to the measured supply temperature. If the measured temperature differs from the calculated, the controller adjusts the mixing valve to raise or lower the supply temperature in the zone.

HEATING/COOLING

The zones (if set to **Stand Alone** Control and heating/cooling enabled) can switch between heating and cooling using one of the following functions (set in the startup wizard):

- **Indoor and Outdoor** uses the indoor and outdoor temperatures to switch the zones between heating and cooling.
- **Supply Water Temp.** uses the supply water temperature to switch the zones between heating and cooling.
- **Contact Input** uses an external signal to switch the zones between heating and cooling.
- **Force Heating** sets the zones in forced heating.
- **Force Cooling** sets the zone in forced cooling.

If one of the zones is set to **Smatrix Base PRO** the Base PRO system will perform the heating/cooling switching. The optional room temperature sensor is placed in a reference area and enables an indoor temperature setpoint parameter. It is used to keep fluctuations in the indoor temperature close to a minimum and as close as possible to the indoor temperature setpoint. In cooling mode it is also used for dew point calculation.

7.2 Controller layout

The illustration below shows parts of the controller.

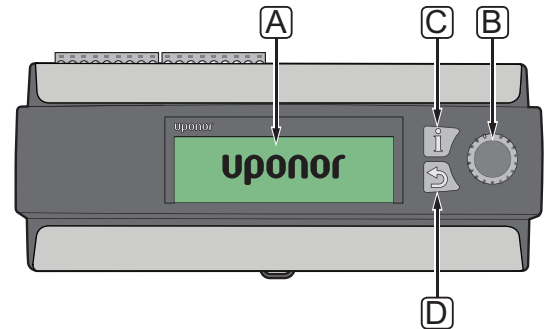

Item	Description
A	Display
B	Navigation wheel/ OK button Used for navigating the menu system, selecting options and confirming selections.
C	Information button Used for showing current zone information such as supply temperature, pump status etc. Push the button repeatedly to switch zones.
D	Back button

7.3 Navigating the menu system

SELECT/CHANGE

Turn the control wheel to select an option, or to change a parameter setting.

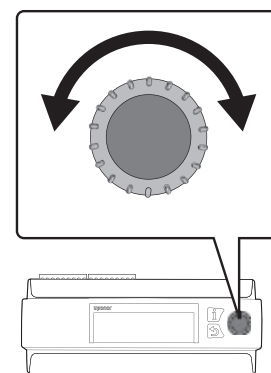

CONFIRM

Press the control wheel to confirm a selection or parameter setting.

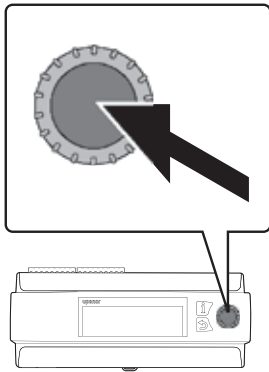
**7.4 Start up**

When starting up, the controller shows the Uponor logo before entering the main menu.

**NOTE!**

The display on the controller may start flashing when powered on. This only occurs after a firmware update and regular operation will continue shortly after.

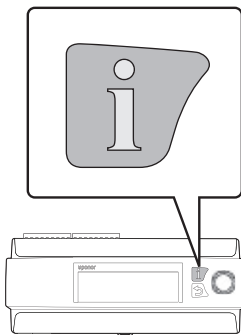
7.5 Information button

The information button can be pressed anytime to get instant access to a summary of current information in the zones. Press the button several times to toggle between the different zones. Press the back button to return to the menu system.

STAND ALONE CONTROL

The following information is shown if the zone is setup as **Stand Alone Control**.

- Supply Temperature (current supply temperature)
- Indoor Temperature (current indoor temperature in the reference room requires a room temperature sensor).
- Outdoor Temperature (current outdoor temperature)
- Pump (status). This information is not shown if a dehumidifier is enabled in the zone.
- Mixing valve (status)

If **System Type** is set to **4 Pipe**, and **Operation Mode** for the zone is set to **Only Heating**, then **Heating Mode** for the zone must be set to **Outdoor + Indoor comp.** to show this information.

SMATRIX BASE PRO

The following information is shown if the zone is setup as **Smatrix Base PRO**.

- Supply Temperature (current supply temperature)
- Indoor Temperature (current indoor temperature, worst case or average temperature from integrated Smatrix Base PRO system is used). This information is only shown when there is a heating/cooling demand in the Smatrix Base PRO system.
- Outdoor Temperature (current outdoor temperature)
- Mixing valve (status)

If **System Type** is set to **4 Pipe**, and **Operation Mode** for the zone is set to **Only Heating**, then **Heating Mode** for the zone must be set to **Outdoor + Indoor comp.** to show this information.

DOMESTIC HOT WATER

The following information is shown if the zone is setup as **Domestic Hot Water**.

- Supply Temperature (current supply temperature)
- Return Temperature (current return temperature)
- Pump (status)
- Mixing valve (status)

MELTAWAY

The following information is shown if the zone is setup as **Meltaway**.

- Supply Temperature (current supply temperature)
- Outdoor Temperature (current outdoor temperature)
- Status (current meltaway statu.: Stop, Idle, Melting, Protection)
- Pump (status)
- Mixing valve (status)

7.6 Main menu

The main menu is the base of the menu system, giving access to 4 different menu alternatives. Use the navigation wheel to navigate the menus and parameter settings.

System Overview	
	Z1 - Supply Temperature 35.5 °C
	Z2 - Supply Temperature 30.1 °C
	Z3 - Supply Temperature 18.9 °C
	Outdoor Temperature 27.4 °C

Icon	Description
	System Overview - Current outdoor temperature, and supply temperatures for enabled zones are shown.
	Information - System, zone (enabled zones only) and controller information are shown in this menu.
	Alarms - Active alarms and alarm history are shown in this menu. Acknowledge alarms and/or reset alarm history.
	Settings - System, zone (enabled zones only) and controller parameters can be set in this menu.

7.7 System Overview

This menu shows the current outdoor temperature, and supply temperatures for enabled zones.

Z# - SUPPLY TEMPERATURE

The current supply temperature is shown. The temperature is measured by the supply temperature sensor wired to the controller.

OUTDOOR TEMPERATURE

The current outdoor temperature is shown. The temperature is measured by an outdoor temperature sensor wired to either the controller or to a connected Smatrix Base PRO system.

7.8 Information

This menu shows information about the system, enabled zones and the controller (when the operating mode is set to **Standard** in the startup wizard).

Menu tree*

Information	System information
	Zone 1 Information
	Zone 2 Information
	Zone 3 Information
	Controller Information

* Parts of the menu tree may only be visible in the Move PRO controller depending on its current configuration.

SYSTEM INFORMATION

The system information menu shows the current time and date.

If **Operating Mode** is set to **Standard** the measured outdoor temperature (from either the controller or from a connected Smatrix Base PRO system, see section 5.7 *Connect sensors to controller > Outdoor sensor for more information*) is also shown.

ZONE 1 INFORMATION

This menu shows information about zone 1.

Menu tree*

Zone 1 Information	
	Zone Setup
	Heating Mode
	Operating Mode
	Supply temperature
	Indoor temperature
	Mixing Valve
	Pump
	Heating
	Cooling

* Parts of the menu tree may only be visible in the Move PRO controller depending on its current configuration.

Zone Setup

The selected zone setup is shown:

- Stand Alone Control
- Smatrix Base PRO (integrated with a Smatrix Base PRO system)

Heating Mode

The selected heating mode for the zone is shown:

- Outdoor (only the outdoor temperature sensor is used)
- Outdoor + Indoor comp. (the outdoor temperature sensor is used together with room temperature data)

This information is only shown if one of the following conditions is met:

- **System Type** is set to **4 Pipe**, and **Z1&2 Operation Mode** is set to **Only Heating** or **Heating and Cooling**.
- **System Type** is set to **2 Pipe**, and **Indoor Cooling Only** is set to **No**.

Operating Mode

The current operating mode (heating or cooling) for the zone is shown:

Supply temperature

The current supply temperature is shown. The temperature is measured by the supply temperature sensor wired to the controller.

Indoor temperature

The current indoor temperature for the zone is shown.

If the zone is setup as **Stand Alone Control** the temperature is measured by a room temperature sensor wired to the Move PRO controller. This information is always shown, except if **System Type** is set to **4 Pipe**, **Z1&2 Operation Mode** is set to **Only Heating**, and **Heating Mode** is set to **Outdoor**.

If the zone is setup as **Smatrix Base PRO** the Base PRO controller sends either **Average** or **Worst Case** (setup in the startup wizard) temperatures from the Base PRO system. This information is shown when there is a heating/cooling demand in the zone, except if **System Type** is set to **4 Pipe**, **Z1&2 Operation Mode** is set to **Only Heating**, and **Heating Mode** is set to **Outdoor**.

Mixing Valve

The status of the mixing valve is shown. 0 % (supply from heat source closed) – 100 % (supply from heat or cooling source fully opened).

Pump

The status of the circulation pump is shown (on/off).

This information is only shown if **Zone Setup** is set to **Stand Alone Control**, and if **Dehumidifier Control** is **Disabled**.

Heating

This menu shows current heating mode information in the zone.

This information is only shown if one of the following conditions is met:

- **System Type** is set to **4 Pipe**, and **Z1&2 Operation Mode** is set to **Only Heating** or **Heating and Cooling**.
- **System Type** is set to **2 Pipe**, and **Indoor Cooling Only** is set to **No**.

MENU TREE*

Heating	
	Heating Curve
	Calculated Supply Setpoint
	ECO-Comf Status

* Parts of the menu tree may only be visible in the Move PRO controller depending on its current configuration.

HEATING CURVE

This menu shows the heating curve, and max/min supply temperature limits, for the zone.

CALCULATED SUPPLY SETPOINT

The calculated supply temperature is shown. The setpoint is calculated using the sensor setup selected in **Heating Mode**.

ECO-COMF STATUS

The current ECO/Comfort status for the zone is shown.

This information is only shown if **Zone Setup** is set to **Stand Alone Control** and **Heating Mode** is set to **Outdoor + Indoor comp.**

Cooling

This menu shows current cooling mode information in the zone.

This information is only shown if one of the following conditions is met:

- **System Type** is set to **4 Pipe**, and **Z1&2 Operation Mode** is set to **Only Cooling** or **Heating and Cooling**.
- **System Type** is set to **2 Pipe**.

MENU TREE*

Cooling	
	Cooling Curve
	Calculated Supply Setpoint
	Condensation
	Relative Humidity
	Dew Point Temperature
	Dehumidifier

* Parts of the menu tree may only be visible in the Move PRO controller depending on its current configuration.

COOLING CURVE

This menu shows the cooling curve, and max/min supply temperature limits, for the zone.

CALCULATED SUPPLY SETPOINT

The calculated supply temperature for cooling is shown.

CONDENSATION

The current condensation status (Yes/No) in the zone is shown.

This menu is only shown if **Condensation Sensor** is enabled in the startup wizard for the zone.

RELATIVE HUMIDITY

The relative humidity level in the zone is shown.

If the zone is setup as **Stand Alone Control** the relative humidity is measured by a relative humidity sensor wired to the Move PRO controller.

If the zone is setup as **Smatrix Base PRO** the Base PRO controller sends the highest relative humidity level from the Base PRO system (measured at thermostats with RH sensors and an active cooling demand).

DEW POINT TEMPERATURE

The current dew point temperature in the zone is shown.

DEHUMIDIFIER

The status of the dehumidifier in the zone is shown (on/off).

This information is only shown if **Dehumidifier Control** is **Enabled**.

ZONE 2 INFORMATION

This menu shows information about zone 2.

Menu tree*

Zone 2 Information	
	Zone Setup
	Heating Mode
	Operating Mode
	Supply temperature
	Indoor temperature
	DHW Circ. Return Temp
	Mixing Valve
	Pump
	Heating
	Cooling

* Parts of the menu tree may only be visible in the Move PRO controller depending on its current configuration.

Zone Setup

The selected zone setup is shown:

- Stand Alone Control
- Smatrix Base PRO (integrated with a Smatrix Base PRO system)
- Domestic Hot Water (DHW)

Heating Mode

The selected heating mode for the zone is shown:

- Outdoor (only the outdoor temperature sensor is used)
- Outdoor + Indoor comp. (the outdoor temperature sensor is used together with room temperature data)

This information is only shown if one of the following conditions is met:

- **System Type** is set to **4 Pipe, Z1&2 Operation Mode** is set to **Only Heating** or **Heating and Cooling**, and **Zone Setup** is set to **Stand Alone Control** or **Smatrix Base PRO**.
- **System Type** is set to **2 Pipe, Indoor Cooling Only** is set to **No**, and **Zone Setup** is set to **Stand Alone Control** or **Smatrix Base PRO**.

Operating Mode

The current operating mode (heating or cooling) for the zone is shown:

Supply temperature

The current supply temperature is shown. The temperature is measured by the supply temperature sensor wired to the controller.

Indoor temperature

The current indoor temperature for the zone is shown.

If the zone is setup as **Stand Alone Control** the temperature is measured by a room temperature sensor wired to the Move PRO controller. This information is always shown, except if **System Type** is set to **4 Pipe, Z1&2 Operation Mode** is set to **Only Heating**, and **Heating Mode** is set to **Outdoor**.

If the zone is setup as **Smatrix Base PRO** the Base PRO controller sends either **Average** or **Worst Case** (setup in the startup wizard) temperatures from the Base PRO system. This information is shown when there is a heating/cooling demand in the zone, except if **System Type** is set to **4 Pipe, Z1&2 Operation Mode** is set to **Only Heating**, and **Heating Mode** is set to **Outdoor**.

DHW Circ. Return Temp

The current return temperature is shown.

This information is only shown if **Zone Setup** is set to **Domestic Hot Water**.

Mixing Valve

The status of the mixing valve is shown. 0 % (supply from heat source closed) – 100 % (supply from heat or cooling source fully opened).

Pump

The status of the circulation pump is shown (on/off).

This information is only shown if **Zone Setup** is set to **Stand Alone Control** or **Domestic Hot Water**, and if **Dehumidifier Control** is **Disabled**.

Heating

This menu shows current heating mode information in the zone.

This information is only shown if one of the following conditions is met:

- **System Type** is set to **4 Pipe**, and **Z1&2 Operation Mode** is set to **Only Heating** or **Heating and Cooling**.
- **System Type** is set to **2 Pipe**, and **Indoor Cooling Only** is set to **No**.

MENU TREE*

Heating	
	Heating Curve
	Calculated Supply Setpoint
	ECO-Comf Status

* Parts of the menu tree may only be visible in the Move PRO controller depending on its current configuration.

HEATING CURVE

This menu shows the heating curve, and max/min supply temperature limits, for the zone.

CALCULATED SUPPLY SETPOINT

The calculated supply temperature is shown. The setpoint is calculated using the sensor setup selected in **Heating Mode**.

ECO-COMF STATUS

The current ECO/Comfort status for the zone is shown.

This information is only shown if **Zone Setup** is set to **Stand Alone Control** and **Heating Mode** is set to **Outdoor + Indoor comp.**

Cooling

This menu shows current cooling mode information in the zone.

This information is only shown if one of the following conditions is met:

- **System Type** is set to **4 Pipe**, and **Z1&2 Operation Mode** is set to **Only Cooling** or **Heating and Cooling**.
- **System Type** is set to **2 Pipe**.

MENU TREE*

Cooling	
	Cooling Curve
	Calculated Supply Setpoint
	Condensation
	Relative Humidity
	Dew Point Temperature
	Dehumidifier

* Parts of the menu tree may only be visible in the Move PRO controller depending on its current configuration.

COOLING CURVE

This menu shows the cooling curve, and max/min supply temperature limits, for the zone.

CALCULATED SUPPLY SETPOINT

The calculated supply temperature for cooling is shown.

CONDENSATION

The current condensation status (Yes/No) in the zone is shown.

This menu is only shown if **Condensation Sensor** is enabled in the startup wizard for the zone.

RELATIVE HUMIDITY

The relative humidity level in the zone is shown.

If the zone is setup as **Stand Alone Control** the relative humidity is measured by a relative humidity sensor wired to the Move PRO controller.

If the zone is setup as **Smatrix Base PRO** the Base PRO controller sends the highest relative humidity level from the Base PRO system (measured at thermostats with RH sensors and an active cooling demand).

DEW POINT TEMPERATURE

The current dew point temperature in the zone is shown.

DEHUMIDIFIER

The status of the dehumidifier in the zone is shown (on/off).

This information is only shown if **Dehumidifier Control** is **Enabled**.

ZONE 3 INFORMATION

This menu shows information about zone 3.

Menu tree*

Zone 3 Information	
	Zone Setup
	Heating Mode
	Operating Mode
	Supply temperature
	Indoor temperature
	Calculated Supply Setpoint
	Indoor temperature
	Meltaway Curve
	Return temperature
	Ground Temperature
	Ground Moisture
	Primary Return Temperature
	Status
	Mixing Valve
	Pump
	Heating
	Cooling

* Parts of the menu tree may only be visible in the Move PRO controller depending on its current configuration.

Zone Setup

The selected zone setup is shown:

- Stand Alone Control
- Smatrix Base PRO (integrated with a Smatrix Base PRO system)
- Meltaway

Heating Mode

The selected heating mode for the zone is shown:

- Outdoor (only the outdoor temperature sensor is used)
- Outdoor + Indoor comp. (the outdoor temperature sensor is used together with room temperature data)

This information is only shown if one of the following conditions is met:

- **System Type** is set to **4 Pipe, Z3 Operation Mode** is set to **Only Heating** or **Heating and Cooling**, and **Zone Setup** is set to **Stand Alone Control** or **Smatrix Base PRO**.
- **System Type** is set to **2 Pipe, Indoor Cooling Only** is set to **No**, and **Zone Setup** is set to **Stand Alone Control** or **Smatrix Base PRO**.

Operating Mode

The current operating mode (heating or cooling) for the zone is shown:

Supply temperature

The current supply temperature is shown. The temperature is measured by the supply temperature sensor wired to the controller.

Calculated Supply Setpoint

The calculated supply temperature for meltaway is shown.

This information is only shown if **Zone Setup** is set to **Meltaway**.

Indoor temperature

The current indoor temperature for the zone is shown.

If the zone is setup as **Stand Alone Control** the temperature is measured by a room temperature sensor wired to the Move PRO controller. This information is always shown, except if **System Type** is set to **4 Pipe**, **Z3 Operation Mode** is set to **Only Heating**, and **Heating Mode** is set to **Outdoor**.

If the zone is setup as **Smatrix Base PRO** the Base PRO controller sends either **Average** or **Worst Case** (setup in the startup wizard) temperatures from the Base PRO system. This information is shown when there is a heating/cooling demand in the zone, except if **System Type** is set to **4 Pipe**, **Z3 Operation Mode** is set to **Only Heating**, and **Heating Mode** is set to **Outdoor**.

Meltaway Curve

This menu shows the meltaway curve, and max/min supply temperature limits, for the zone.

This information is only shown if **Zone Setup** is set to **Meltaway**.

Return temperature

The current return temperature is shown.

This information is only shown if **Zone Setup** is set to **Meltaway**.

Ground Temperature

The current temperature in the ground around the snow sensor is shown.

This information is only shown if **Zone Setup** is set to **Meltaway**.

Ground Moisture

This parameter shows if there is moisture around the snow sensor.

This information is only shown if **Zone Setup** is set to **Meltaway**.

Primary Return temperature

The current primary return temperature is shown.

This information is only shown if **Zone Setup** is set to **Meltaway**.

Status

This parameter shows the current meltaway status.

Stop: Meltaway is inactive.

Idle: Meltaway is idle and the supply temperature is kept low to keep the zone from getting too cold.

Melting: Meltaway is active.

Protection: Protecting the heat source from low return temperatures.

The status may change, in case of sensor fault. An alarm will also be shown in the display if that is the case.

This information is only shown if **Zone Setup** is set to **Meltaway**.

Mixing Valve

The status of the mixing valve is shown. 0 % (supply from heat source closed) – 100 % (supply from heat or cooling source fully opened).

Pump

The status of the circulation pump is shown (on/off).

This information is only shown if **Zone Setup** is set to **Stand Alone Control** or **Meltaway**, and if **Dehumidifier Control** is **Disabled**.

Heating

This menu shows current heating mode information in the zone.

This information is only shown if one of the following conditions is met:

- **System Type** is set to **4 Pipe**, and **Z3 Operation Mode** is set to **Only Heating** or **Heating and Cooling**.
- **System Type** is set to **2 Pipe**, and **Indoor Cooling Only** is set to **No**.

MENU TREE*

Heating	
	Heating Curve
	Calculated Supply Setpoint
	ECO-Comf Status

* Parts of the menu tree may only be visible in the Move PRO controller depending on its current configuration.

HEATING CURVE

This menu shows the heating curve, and max/min supply temperature limits, for the zone.

CALCULATED SUPPLY SETPOINT

The calculated supply temperature is shown. The setpoint is calculated using the sensor setup selected in **Heating Mode**.

ECO-COMF STATUS

The current ECO/Comfort status for the zone is shown.

This information is only shown if **Zone Setup** is set to **Stand Alone Control** and **Heating Mode** is set to **Outdoor + Indoor comp..**

Cooling

This menu shows current cooling mode information in the zone.

This information is only shown if one of the following conditions is met:

- **System Type** is set to **4 Pipe**, and **Z3 Operation Mode** is set to **Only Cooling** or **Heating and Cooling**.
- **System Type** is set to **2 Pipe**.

MENU TREE*

Cooling	
	Cooling Curve
	Calculated Supply Setpoint
	Condensation
	Relative Humidity
	Dew Point Temperature
	Dehumidifier

* Parts of the menu tree may only be visible in the Move PRO controller depending on its current configuration.

COOLING CURVE

This menu shows the cooling curve, and max/min supply temperature limits, for the zone.

CALCULATED SUPPLY SETPOINT

The calculated supply temperature for cooling is shown.

CONDENSATION

The current condensation status (Yes/No) in the zone is shown.

This menu is only shown if **Condensation Sensor** is enabled in the startup wizard for the zone.

RELATIVE HUMIDITY

The relative humidity level in the zone is shown.

If the zone is setup as **Stand Alone Control** the relative humidity is measured by a relative humidity sensor wired to the Move PRO controller.

If the zone is setup as **Smatrix Base PRO** the Base PRO controller sends the highest relative humidity level from the Base PRO system (measured at thermostats with RH sensors and an active cooling demand).

DEW POINT TEMPERATURE

The current dew point temperature in the zone is shown.

DEHUMIDIFIER

The status of the dehumidifier in the zone is shown (on/off).

This information is only shown if **Dehumidifier Control** is **Enabled**.

CONTROLLER INFORMATION

This menu shows information about the controller.

Menu tree

Controller Information	
	Language
	About...

Language

This menu show the set display language for the controller.

About...

This menu shows the serial number, software versions, and hardware versions of the controller.

7.9 Alarms

This menu shows the current active alarms and the alarm history. A possibility of acknowledging all alarms and resetting the alarm history is also available.

Active alarms are always indicated with a ! and an number (of alarms) in the upper right corner of the display. Acknowledge the active alarms to remove the alarm indicator.

Menu tree

Alarms	
	Active alarms
	Alarm history
	Acknowledge all alarms
	Reset alarm history

ACTIVE ALARMS

This menu shows a list of all active alarms in the controller. Each active alarm is presented with a short description about when it was logged, why it occurred, and if it has been acknowledged (indicated with a !). Detailed information is available via button press.

The detailed information shows alarm type, time and date when it was logged, the source of the alarm with severity (PR1 to PR5, where PR5 is the worst), and which alarm group it belongs to (1 to 10). The alarm can also be acknowledged in the detailed information.

To access detailed alarm information:

1. Select an alarm.
2. Press the navigation wheel to confirm selection.

ALARM HISTORY

This menu shows a list of the 10 latest alarms in the controller. Each active alarm is presented with a short description about when it was logged and why it occurred. Detailed information is available via button press.

The detailed information shows alarm type, time and date when it was logged, the source of the alarm with severity (PR1 to PR5, where PR5 is the worst), and which alarm group it belongs to (1 to 10).

To access detailed alarm information:

1. Select an alarm.
2. Press the navigation wheel to confirm selection.

ACKNOWLEDGE ALL ALARMS

This menu enables to acknowledge all active alarms.

To acknowledge all active alarms:

1. Select **Acknowledge all alarms**.
2. Press the navigation wheel to confirm selection.
3. Select **Yes**.
Setting range: No (default)/Yes
4. Press the navigation wheel to confirm selection.

RESET ALARM HISTORY

This menu enables to reset the alarm history.

To reset the alarms history:

1. Select **Reset alarm history**.
2. Press the navigation wheel to confirm selection.
3. Select **Yes**.
Setting range: No (default)/Yes
4. Press the navigation wheel to confirm selection.

7.10 Settings

In this menu installer settings, enabled zone settings, and controller settings can be changed (when the operating mode is set to **Standard** in the startup wizard).

Menu tree*

Settings	
	Installer Settings
	Zone 1 Settings
	Zone 2 Settings
	Zone 3 Settings
	HC Switchover
	Controller Settings

* Parts of the menu tree may only be visible in the Move PRO controller depending on its current configuration.

INSTALLER SETTINGS

In this menu lock codes (to gain access to locked parameter settings) can be set or changed, factory settings can be restored, backup of controller parameter settings can be managed, or the setup wizard can be restarted.

Menu tree

Installer Settings	
	T Outdoor Fallback
	Lock code
	Change lock code
	Display settings
	Restore factory settings
	Restore backup
	New backup
	Restart wizard

T Outdoor Fallback

In this menu the fallback temperature for the outdoor temperature sensor is set. This value will be used if the connection to the outdoor temperature sensor is lost.

To set the fallback temperature for the outdoor temperature sensor:

1. Select **T Outdoor Fallback**.
2. Press the navigation wheel to confirm selection.
3. Set the value.
Default: 0 °C
Setting range: -50 – 50 °C, 1 °C increments
4. Confirm the new setting by pressing the navigation wheel again.

Lock code

A lock code can be used to block a user from changing parameter settings. The menu system is fully accessible, but the lock code is required to enter and change parameter settings.

The default lock code is 0000. It is recommended to change this code if using this function.

The controller locks itself when it has been left untouched for about 10 minutes.

To enable lock code in the controller:

1. Select **Lock code**.
2. Press the navigation wheel to confirm selection.
3. Select **Enable**.
4. Press the navigation wheel to confirm selection.

ENTERING A MENU WHEN LOCK CODE IS ENABLED

To enter a lock code:

1. Select the parameter.
2. Press the navigation wheel to confirm selection.
3. Enter the lock code in the boxes using the navigation wheel.

Turn the navigation wheel to either select a box, or to increase/decrease a value in edit mode.

Press the navigation wheel to enter edit mode or to confirm the new setting.

Default: 0000

4. Confirm the lock code by pressing and holding the navigation wheel for a number of seconds.
5. Change the parameter setting and exit.

Change lock code

The standard lock code which is used to block a user from changing parameter settings, can be changed in this menu.

This menu is only shown when **Lock code** has been enabled in the **Lock code** menu.



NOTE!

If the controller display is already locked, it has to be unlocked before entering the new lock code.

To change the lock code:

1. Select **Change lock code**.
2. Press the navigation wheel to confirm selection.
3. Enter the new lock code in the boxes using the navigation wheel.

Turn the navigation wheel to either select a box, or to increase/decrease a value in edit mode.

Press the navigation wheel to enter edit mode or to confirm the new setting.

Default: 0000

4. Confirm the new lock code by pressing and holding the navigation wheel for about 8 seconds.

Display settings

This menu enables display settings, such as contrast, and it also shows the version number of the display software.

To set the display contrast:

1. Select **Display settings**.
2. Press the navigation wheel to confirm selection.
3. Select **Display contrast**.
4. Press the navigation wheel to confirm selection.
5. Set the display contrast.
Setting range: -50 – 100 %, 1 % increments
6. Press the navigation wheel to confirm selection.

Restore factory settings

This menu enables all parameter settings in the controller to be reset to the factory default settings.

To restore the factory settings:

1. Select **Restore factory settings**.
2. Press the navigation wheel to confirm selection.
3. Select **Yes**.
Setting range: No (default)/Yes
4. Press the navigation wheel to confirm selection.
5. All parameters in the controller are being restored to factory settings.

Restore backup

This menu enables the controller to restore all parameter settings from a previously created backup located on the microSD-card.

To restore from a backup:

1. Make sure the microSD-card with the backup is inserted into the controller.
2. Select **Restore backup**.
3. Press the navigation wheel to confirm selection.
4. Select **Yes**.
Setting range: No (default)/Yes
5. Press the navigation wheel to confirm selection.
6. All parameters in the controller are being restored from backup.

New backup

This menu enables the controller to save a backup of all parameter settings to the microSD-card.

To save from a backup:

1. Make sure a microSD-card, where the backup is to be saved, into the controller.
2. Select **New backup**.
3. Press the navigation wheel to confirm selection.
4. Select **Yes**.
Setting range: No (default)/Yes
5. Press the navigation wheel to confirm selection.
6. All parameters in the controller are being saved to the microSD card.

Restart wizard

This menu enables the controller to restart the setup wizard.

To restart the setup wizard:

1. Select **Restart wizard**.
2. Press the navigation wheel to confirm selection.
3. Select **Yes**.
Setting range: No (default)/Yes
4. Press the navigation wheel to confirm selection.
5. The setup wizard is now being restarted.

ZONE 1 SETTINGS

In this menu parameter settings for zone 1 can be set or changed.

Menu tree*

Zone 1 Settings	
	Supply Temp. Settings
	Heating Indoor Temp. Settings
	Conf. - ECO
	Heating Curve
	Cooling Curve
	Manual Operation
	Pump
	Mixing Valve
	Dehumidifier Control
	Seasonal Shut Off
	H/C Switchover
	Condensation Delay

* Parts of the menu tree may only be visible in the Move PRO controller depending on its current configuration.

Supply Temp. Settings

This menu enables access to settings related to the supply temperature in the zone.

MENU TREE*

Supply Temp. Settings	
	Heating
	Cooling

* Parts of the menu tree may only be visible in the Move PRO controller depending on its current configuration.

HEATING

This menu enables access to settings related to the heating supply temperature in the zone.

This menu is only shown if one of the following requirements are met:

- **System Type** is set to **2 Pipe** and **Indoor Cooling Only** is set to **No**.
- **System Type** is set to **4 Pipe** and **Z1&2 Operation Mode** is set to **Only Heating** or **Heating And Cooling**.

MENU TREE

Heating	
	Calculated Supply Setpoint
	Heating Min. Supply Temp.
	Heating Max. Supply Temp.
	Deviation alarm limit
	Deviation alarm delay

CALCULATED SUPPLY SETPOINT

In this menu the calculated supply setpoint for the zone can be overridden. This temperature is used as setpoint for the supply temperature.

To override the calculated supply setpoint:

1. Select **Calculated supply setpoint**.
2. Press the navigation wheel to confirm selection.
3. Select **Manual**.
4. Set the override value.
Setting range: -5.0 – 70.0 °C, 0.1 °C increments
5. Confirm the new setting by pressing the navigation wheel again.

HEATING MIN. SUPPLY TEMP.

In this menu the minimum allowed supply temperature for the zone can be set. The supply temperature is not allowed to fall below this value.

To set the minimum allowed supply temperature:

1. Select **Heating Min. supply temp**.
2. Press the navigation wheel to confirm selection.
3. Set the value.
Default: 15.0 °C
Setting range: 5.0 – 35.0 °C (or max. supply temp), 0.1 °C increments
4. Confirm the new setting by pressing the navigation wheel again.

HEATING MAX. SUPPLY TEMP.

In this menu the maximum allowed supply temperature for the zone can be set. The supply temperature is not allowed to rise above this value.

To set the maximum allowed supply temperature:

1. Select **Heating Max. supply temp**.
2. Press the navigation wheel to confirm selection.
3. Set the value.
Default: 70.0 °C
Setting range: 5.0 (or min. supply temp) – 90.0 °C, 0.1 °C increments
4. Confirm the new setting by pressing the navigation wheel again.

DEVIATION ALARM LIMIT

In this menu the deviation alarm limit for the supply temperature in the zone is set. If the difference between the measured and the calculated supply temperatures are higher than the set limit during the time set in **Deviation alarm delay**, the alarm is triggered.

To set the deviation alarm limit:

1. Select **Deviation alarm limit**.
2. Press the navigation wheel to confirm selection.
3. Set the value.
Default: 10.0 °C
Setting range: 0.0 – 50.0 °C, 0.1 °C increments
4. Confirm the new setting by pressing the navigation wheel again.

DEVIATION ALARM DELAY

In this menu the deviation alarm delay for the deviation alarm limit in the zone is set. If the difference between the measured and the calculated supply temperatures are higher than **Deviation alarm limit** during the set delay, the alarm is triggered.

To set the deviation alarm delay:

1. Select **Deviation alarm delay**.
2. Press the navigation wheel to confirm selection.
3. Set the value.
Default: 5 min
Setting range: 0 – 30 min, 1 min increments
4. Confirm the new setting by pressing the navigation wheel again.

COOLING

This menu enables access to settings related to the cooling supply temperature in the zone.

This menu is only shown if one of the following requirements are met:

- **System Type** is set to **2 Pipe**.
- **System Type** is set to **4 Pipe** and **Z1&2 Operation Mode** is set to **Only Cooling** or **Heating And Cooling**.

MENU TREE

Cooling	
	Calculated Supply Setpoint
	Cooling Min. Supply Temp.
	Cooling Max. Supply Temp.
	Dew Point Margin
	Dew Point Offset

CALCULATED SUPPLY SETPOINT

In this menu the calculated supply setpoint for the zone can be overridden. This temperature is used as setpoint for the supply temperature.

To override the calculated supply setpoint:

1. Select **Calculated supply setpoint**.
2. Press the navigation wheel to confirm selection.
3. Select **Manual**.
4. Set the override value.
Setting range: -5.0 – 70.0 °C, 0.1 °C increments
5. Confirm the new setting by pressing the navigation wheel again.

COOLING MIN. SUPPLY TEMP.

In this menu the minimum allowed supply temperature for the zone can be set. The supply temperature is not allowed to fall below this value.

To set the minimum allowed supply temperature:

1. Select **Cooling Min. supply temp.**
2. Press the navigation wheel to confirm selection.
3. Set the value.
Default: 8.0 °C
Setting range: 5.0 – 40.0 °C (or max. supply temp), 0.1 °C increments
4. Confirm the new setting by pressing the navigation wheel again.

COOLING MAX. SUPPLY TEMP.

In this menu the maximum allowed supply temperature for the zone can be set. The supply temperature is not allowed to rise above this value.

To set the maximum allowed supply temperature:

1. Select **Cooling Max. supply temp.**
2. Press the navigation wheel to confirm selection.
3. Set the value.
Default: 25.0 °C
Setting range: 5.0 (or min. supply temp) – 40.0 °C, 0.1 °C increments
4. Confirm the new setting by pressing the navigation wheel again.

DEW POINT MARGIN

In this menu the dew point margin for the zone can be set. The dew point temperature is calculated using the current room temperature and relative humidity.

When the calculated supply temperature is lower than the dew point temperature + **Dew Point Offset** this value is added to the calculated supply temperature.

To set the dew point margin:

1. Select **Dew Point Margin**.
2. Press the navigation wheel to confirm selection.
3. Set the value.
Default: 4.0 °C
Setting range: -1.0 – 10.0 °C
4. Confirm the new setting by pressing the navigation wheel again.

DEW POINT OFFSET

In this menu the dew point offset for the zone can be set. The dew point temperature is calculated using the current room temperature and relative humidity.

The offset is used together with the dew point temperature to decide when to increase the calculated supply temperature with the value set in **Dew Point Margin**.

To set the dew point offset:

1. Select **Dew Point Offset**.
2. Press the navigation wheel to confirm selection.
3. Set the value.
Default: 1.0 °C
Setting range: 0.0 – 4.0 °C
4. Confirm the new setting by pressing the navigation wheel again.

Heating Indoor Temp. Settings

This menu enables access to settings related to the room temperature sensor in the zone.

This menu and its submenus are only shown if **Heating Mode** is set to **Outdoor + Indoor comp.** for the zone.

MENU TREE*

Heating Indoor Temp. Settings	
	Indoor Setpoint
	Calculated Indoor Setpoint
	ECO-Comf. Status
	Indoor Setpoint Influence (Lower)
	Indoor Setpoint Influence (Upper)

* Parts of the menu tree may only be visible in the Move PRO controller depending on its current configuration.

INDOOR SETPOINT

In this menu the indoor temperature setpoint for the zone is set.

This information is only shown if **Zone Setup** is set to **Stand Alone Control** for the zone.

To set the indoor temperature setpoint:

1. Select **Indoor Setpoint**.
2. Press the navigation wheel to confirm selection.
3. Set the value.
Default: 21.0 °C
Setting range: 5.0 – 35.0 °C, 0.1 °C increments
4. Confirm the new setting by pressing the navigation wheel again.

CALCULATED INDOOR SETPOINT

This menu shows the calculated indoor setpoint for the zone.

This information is only shown if **Zone Setup** is set to **Stand Alone Control** and if ECO-Comf mode is set to ECO for the zone.

ECO-COMF STATUS

This menu shows if the zone is set in ECO mode.

This information is only shown if ECO-Comf mode is set to ECO for the zone.

INDOOR SETPOINT INFLUENCE (LOWER)

In this menu the indoor setpoint influence (lower) is set. If the measured indoor temperature is higher than the indoor temperature setpoint, the supply temperature setpoint will be lowered using this value.

This menu is used to to keep the measured room temperature as close as possible to the indoor temperature setpoint.



NOTE!

If the value is set too high it can lead to the system being unstable and the room temperature will start fluctuating.

To set the indoor setpoint influence (lower):

1. Select **Indoor Setpoint Influence (Lower)**.
2. Press the navigation wheel to confirm selection.
3. Set the value.
Default: 4.0 °C
Setting range: 0.0 – 10.0 °C, 0.1 °C increments
4. Confirm the new setting by pressing the navigation wheel again.

INDOOR SETPOINT INFLUENCE (UPPER)

In this menu the indoor setpoint influence (upper) is set. If the measured indoor temperature is lower than the indoor temperature setpoint, the supply temperature setpoint will be increased using this value.

This menu is used to to keep the measured room temperature as close as possible to the indoor temperature setpoint.



NOTE!

If the value is set too high it can lead to the system being unstable and the room temperature will start fluctuating.

To set the indoor setpoint influence (upper):

1. Select **Indoor Setpoint Influence (Upper)**.
2. Press the navigation wheel to confirm selection.
3. Set the value.
Default: 4.0 °C
Setting range: 0.0 – 10.0 °C, 0.1 °C increments
4. Confirm the new setting by pressing the navigation wheel again.

Comf. - ECO

This menu enables access to settings related to the controller Comfort/ECO modes.

This menu and its submenus are only shown if **Zone Setup** is set to **Stand Alone Control** and if **Heating Mode** is set to **Outdoor + Indoor comp.** for the zone.

MENU TREE

Comf. - ECO	
	ECO Setback
	ECO-Comf Status
	ECO-Comf Schedule

ECO SETBACK

In this menu the ECO setback temperature is set. The parameter reduces the current setpoint with the set value.

If the setback is set to 0 the zone will resume its normal operation, even if it is set in ECO mode.

To set the ECO setback value:

1. Select **ECO Setback**.
2. Press the navigation wheel to confirm selection.
3. Set the value.
Default: 4.0 °C
Setting range: 0.0 – 10.0 °C, 0.1 °C increments
4. Confirm the new setting by pressing the navigation wheel again.

ECO-COMF STATUS

This menu shows if the zone is set in ECO or Comf (comfort) mode.

ECO-COMF SCHEDULE

In this menu a schedule for switching between Comfort and ECO mode can be created.

The default schedule is set to Comfort mode 24h a day, 7 days a week.



WARNING!

Ensure that different schedules cannot enable ECO and Comf and the same time. This may cause an error where the controller must be reset to factory default values.

To edit/create the ECO-Comf Schedule:

1. Select **ECO-Comf Schedule**.
2. Press the navigation wheel to confirm selection.
The current schedule is showing.
3. Select a day.
4. Press the navigation wheel to confirm selection.
All current schedule settings are shown, each line representing a switch between Comfort and ECO mode. If entering the menu for the first time only one line is present, showing Comf starting at 00:00 every day of the week.
5. Select an existing line to edit or **00:00 Add new** to add a new setting.
6. Select whether to edit the hours, minutes, mode or day of the week.

HOURS:

Set at which hour the mode will start and press the navigation wheel to confirm selection.

MINUTES:

Set at which minute of the hour the mode will start and press the navigation wheel to confirm selection.

MODE:

Select a mode which should start at the set time and press the navigation wheel to confirm selection. Select between **Comf**, **ECO** and **Delete switch time**. **Delete switch time** erases the current line when selecting OK and pressing the navigation wheel.

DAY OF THE WEEK:

Select which days of the week, at the set time the selected mode should start.

7. Select **OK** at the end of the line, when done, and press the navigation wheel to confirm selection.
A new line has been added to the schedule.
8. Redo steps 5 and 6 until the schedule is complete.
9. Press the back button on the controller to exit the schedule setup.

Heating Curve

This menu enables access to heating curve settings for the zone. Settings such as the slope (Setting) and offset of the heating curve.

This menu is only shown if one of the following requirements are met:

- **System Type** is set to **2 Pipe**, and **Indoor Cooling Only** is set to **No**.
- **System Type** is set to **4 Pipe**, and **Z1&2 Operation Mode** is set to **Only Heating** or **Heating And Cooling**.

MENU TREE

Heating Curve	
	Setting
	Offset
	Heating Curve

SETTING

In this menu the slope of the heating curve is selected.

To select a heating curve:

1. Select **Setting**.
2. Press the navigation wheel to confirm selection.
3. Set the value.
Default: 0.9
Setting range: 0.1 – 1.6, 0.1 increments
4. Confirm the new setting by pressing the navigation wheel again.

OFFSET

In this menu the the heating curve can be offset. The offset can be used for temporary changes to the heating curve.

To offset the heating curve:

1. Select **Offset**.
2. Press the navigation wheel to confirm selection.
3. Set the value.
Default: 0
Setting range: -8 – 8, 1 increments
4. Confirm the new setting by pressing the navigation wheel again.

HEATING CURVE

This menu shows the heating curve, and max/min supply temperature limits, for the zone.

Cooling Curve

This menu enables access to cooling curve settings for the zone. Settings such as the slope (Setting) and offset of the heating curve.

This menu is only shown if one of the following requirements are met:

- **System Type** is set to **2 Pipe**.
- **System Type** is set to **4 Pipe**, and **Z1&2 Operation Mode** is set to **Only Cooling** or **Heating And Cooling**.

MENU TREE

Cooling Curve	
	Setting
	Offset
	Cooling Curve

SETTING

In this menu the slope of the heating curve is selected.

To select a heating curve:

1. Select **Setting**.
2. Press the navigation wheel to confirm selection.
3. Set the value.
Default: 0.2
Setting range: 0.1 – 1.6, 0.1 increments
4. Confirm the new setting by pressing the navigation wheel again.

OFFSET

In this menu the the heating curve can be offset. The offset can be used for temporary changes to the heating curve.

To offset the heating curve:

1. Select **Offset**.
2. Press the navigation wheel to confirm selection.
3. Set the value.
Default: 0
Setting range: -8 – 8, 1 increments
4. Confirm the new setting by pressing the navigation wheel again.

COOLING CURVE

This menu shows the cooling curve, and max/min supply temperature limits, for the zone.

Manual Operation

This menu enables access to manual operation mode in the zone.

When manual operation mode is activated, access to manual control (override) of the circulation pump and mixing valve is enabled.

MENU TREE*

Manual Operation	
	Manual Mode
	Pump
	Mixing valve

* Parts of the menu tree may only be visible in the Move PRO controller depending on its current configuration.

To activate manual operation mode:

1. Select **Manual Mode**.
2. Press the navigation wheel to confirm selection.
3. Select **On**.
4. Confirm the new setting by pressing the navigation wheel again.

PUMP

In this menu the pump can be overridden and turned on or off manually.

This menu is only shown if **Zone Setup** is set to **Stand Alone Control**, **Dehumidifier** is set to **Disable**, and **Manual Mode** is set to **On**.

To override the circulation pump operation:

1. Select **Pump**.
2. Press the navigation wheel to confirm selection.
3. Select **Manual**.
4. Select **On**.
Default: Off
Setting range: Off/On
5. Confirm the new setting by pressing the navigation wheel again.

MIXING VALVE

In this menu the mixing valve can be overridden opened or closed manually.

This menu is only shown if **Manual Mode** is set to **On**.

To override the mixing valve setting:

1. Select **Mixing valve**.
2. Press the navigation wheel to confirm selection.
3. Select **Manual**.
4. Set the override value.
Default: 0 %
Setting range: 0 – 100 %, 1 % increments.
5. Confirm the new setting by pressing the navigation wheel again.

Pump

This menu enables access to pump settings in the zone.

This menu is only shown if **Zone Setup** is set to **Stand Alone Control**, and if **Dehumidifier** is disabled for the zone.

MENU TREE*

Pump	
	Pump Exercise
	Exercise Day of the Week
	Exercise Hour
	Exercise Min

* Parts of the menu tree may only be visible in the Move PRO controller depending on its current configuration.

PUMP EXERCISE

In this menu pump exercise can be activated.

To activate pump exercise:

1. Select **Pump Exercise**.
2. Press the navigation wheel to confirm selection.
3. Select **Pump Exercise**.
Default: No Exercise
Setting range: No Exercise/Pump Exercise
4. Confirm the new setting by pressing the navigation wheel again.

EXERCISE DAY OF THE WEEK

In this menu the day of the week for pump exercise is set.

This menu is only shown if **Pump Exercise** is set to

Pump Exercise.

To select a day of the week for pump exercise:

1. Select **Exercise Day of the Week**.
2. Press the navigation wheel to confirm selection.
3. Select a day.
Setting range: Monday – Sunday
4. Confirm the setting by pressing the navigation wheel again.

EXERCISE HOUR

In this menu the hour of the day for pump exercise is set.

This menu is only shown if **Pump Exercise** is set to **Pump Exercise**.

To select an hour of the day for pump exercise:

1. Select **Exercise Hour**.
2. Press the navigation wheel to confirm selection.
3. Set the value.
Default: 8 h
Setting range: 0 – 23 h, 1 h increments
4. Confirm the setting by pressing the navigation wheel again.

EXERCISE MIN

In this menu the minute of the hour for pump exercise is set.

This menu is only shown if **Pump Exercise** is set to **Pump Exercise**.

To select a minute of the hour for pump exercise:

1. Select **Exercise Min**.
2. Press the navigation wheel to confirm selection.
3. Set the value.
Default: 0 min
Setting range: 0 – 59 min, 1 min increments
4. Confirm the setting by pressing the navigation wheel again.

Mixing Valve

This menu enables access to mixing valve settings in the zone.

MENU TREE*

Mixing Valve	Heating
	Cooling

* Parts of the menu tree may only be visible in the Move PRO controller depending on its current configuration.

HEATING

This menu enables access to mixing valve settings in the zone while in heating mode.

This menu is only shown if one of the following requirements are met:

- **System Type** is set to **2 Pipe** and **Indoor Cooling Only** is set to **No**.
- **System Type** is set to **4 Pipe** and **Z1&2 Operation Mode** is set to **Only Heating** or **Heating And Cooling**.

MENU TREE

Heating	P-area
	I-time
	Actuator running time

P-AREA

In this menu the P-area for the mixing valve regulation is set.

To set the P-area:

1. Select **P-area**.
2. Press the navigation wheel to confirm selection.
3. Set the value.

Default: 140.0 °C

Setting range: 2.0 – 500.0 °C, 0.1 °C increments

4. Confirm the setting by pressing the navigation wheel again.

I-TIME

In this menu the I-time for the mixing valve regulation is set.

To set the I-time:

1. Select **I-time**.
2. Press the navigation wheel to confirm selection.
3. Set the value.
Default: 35 seconds
Setting range: 5 – 300 seconds, 1 second increments
4. Confirm the setting by pressing the navigation wheel again.

ACTUATOR RUNNING TIME

In this menu the actuator running time for the mixing valve regulation is set.

To set the actuator running time:

1. Select **Actuator running time**.
2. Press the navigation wheel to confirm selection.
3. Set the value.
Default: 120 seconds
Setting range: 0 – 500 seconds, 1 second increments
4. Confirm the setting by pressing the navigation wheel again.

COOLING

This menu enables access to mixing valve settings in the zone while in cooling mode.

This menu is only shown if one of the following requirements are met:

- **System Type** is set to **2 Pipe** and **Indoor Cooling Only** is set to **Yes** or **No**.
- **System Type** is set to **4 Pipe** and **Z1&2 Operation Mode** is set to **Only Cooling** or **Heating And Cooling**.

MENU TREE

Cooling	
	P-area
	I-time
	Actuator running time

P-AREA

In this menu the P-area for the mixing valve regulation is set.

To set the P-area:

1. Select **P-area**.
2. Press the navigation wheel to confirm selection.
3. Set the value.
Default: 200.0 °C
Setting range: 2.0 – 500.0 °C, 0.1 °C increments
4. Confirm the setting by pressing the navigation wheel again.

I-TIME

In this menu the I-time for the mixing valve regulation is set.

To set the I-time:

1. Select **I-time**.
2. Press the navigation wheel to confirm selection.
3. Set the value.
Default: 50 seconds
Setting range: 5 – 300 seconds, 1 second increments
4. Confirm the setting by pressing the navigation wheel again.

ACTUATOR RUNNING TIME

In this menu the actuator running time for the mixing valve regulation is set.

To set the actuator running time:

1. Select **Actuator running time**.
2. Press the navigation wheel to confirm selection.
3. Set the value.
Default: 60 seconds
Setting range: 0 – 500 seconds, 1 second increments
4. Confirm the setting by pressing the navigation wheel again.

Dehumidifier Control

This menu enables access to dehumidifier settings in the zone.

This menu is only shown if **Dehumidifier Control** is enabled in the startup wizard for the zone.

MENU TREE

Dehumidifier Control
Dew Point Margin
Dead Zone

DEW POINT MARGIN

In this menu the dew point margin, for controlling the dehumidifier, in the zone can be set. The dehumidifier is started when the supply temperature is equal or lower than the dew point temperature + dew point margin. The dehumidifier is shut off when the supply temperature is equal or higher than the dew point temperature + dew point margin + deadzone temperature.

To set the dew point margin:

1. Select **Dew Point Margin**.
2. Press the navigation wheel to confirm selection.
3. Set the value.
Default: 4.0 °C
Setting range: -1.0 – 10.0 °C
4. Confirm the new setting by pressing the navigation wheel again.

DEAD ZONE

In this menu the dead zone (hysteresis) for when to shut off the dehumidifier in the zone can be set.

To set the dead zone:

1. Select **Dead Zone**.
2. Press the navigation wheel to confirm selection.
3. Set the value.
Default: 2.0 °C
Setting range: 1.0 – 5.0 °C
4. Confirm the new setting by pressing the navigation wheel again.

Seasonal Shut Off

This menu enables access to seasonal shut off settings in the zone.

MENU TREE*

Seasonal Shut Off
Heating
Cooling

* Parts of the menu tree may only be visible in the Move PRO controller depending on its current configuration.

HEATING

This menu enables access to seasonal shut off settings in the zone, while in heating mode.

This menu is only shown if one of the following requirements are met:

- **System Type** is set to **2 Pipe**, and **Indoor Cooling Only** is set to **No**.
- **System Type** is set to **4 Pipe**, and **Z1&2 Operation Mode** is set to **Only Heating** or **Heating And Cooling**.

MENU TREE*

Heating
Pump Stop
Valve Close
Shut Off Outdoor Temp.
T. Outdoor Setpoint
T. Outdoor Delay
Shut Off Indoor Temp.
T. Indoor Delay

* Parts of the menu tree may only be visible in the Move PRO controller depending on its current configuration.

PUMP STOP

In this menu a function to stop the circulation pump, when requirements are met, is enabled.

This menu is only shown if **Zone Setup** is set to **Stand Alone Control**, and **Dehumidifier** is set to **Disable**.

To enable the function:

1. Select **Pump Stop**.
2. Press the navigation wheel to confirm selection.
3. Select **Enable**.
Default: Disable
Setting range: Disable/Enable
4. Confirm the setting by pressing the navigation wheel again.

VALVE CLOSE

In this menu a function to close the mixing valve, when requirements are met, is enabled.

To enable the function:

1. Select **Valve Close**.
2. Press the navigation wheel to confirm selection.
3. Select **Enable**.
Default: Disable
Setting range: Disable/Enable
4. Confirm the setting by pressing the navigation wheel again.

SHUT OFF OUTDOOR TEMP.

In this menu the function to stop the circulation pump and/or when to close the mixing valve, at an outdoor temperature setpoint is enabled/disabled for the zone.

This menu is only shown if **Pump Stop** and/or **Valve Close** is enabled.

To set an shut off outdoor temperature:

1. Select **Shut Off Outdoor Temp.**
2. Press the navigation wheel to confirm selection.
3. Select **Enable**.
Default: Disable
Setting range: Disable/Enable
4. Confirm the setting by pressing the navigation wheel again.

T. OUTDOOR SETPOINT

In this menu the outdoor temperature setpoint for stopping the circulation pump, and/or closing the mixing valve, in the zone is set.

This menu is only shown if **Shut Off Outdoor Temp.** is enabled.

To set an outdoor temperature setpoint:

1. Select **T Outdoor Setpoint**.
2. Press the navigation wheel to confirm selection.
3. Select **Enable**.
Default: 17.0 °C
Setting range: 0.0 – 40.0 °C, 0.1 °C increments
4. Confirm the setting by pressing the navigation wheel again.

T. OUTDOOR DELAY

In this menu the time delay for how long the outdoor temperature must be equal or higher than **T Outdoor Setpoint** before stopping the circulation pump, and/or closing the mixing valve, in the zone is set.

This menu is only shown if **Shut Off Outdoor Temp.** is enabled.

To set the delay:

1. Select **T. Outdoor Delay**.
2. Press the navigation wheel to confirm selection.
3. Set the value.
Default: 24 h
Setting range: 0 – 24 h, 1 h increments
4. Confirm the setting by pressing the navigation wheel again.

SHUT OFF INDOOR TEMP.

In this menu the function to stop the circulation pump, and/or when to close the mixing valve, at an indoor temperature setpoint is enabled/disabled for the zone.

This menu is only shown if **Pump Stop** and/or **Valve Close** is enabled, and if **Heating Mode** is set to **Outdoor + Indoor comp.** for the zone.

To set an shut off outdoor temperature:

1. Select **Shut Off Outdoor Temp.**
2. Press the navigation wheel to confirm selection.
3. Select **Enable**.
Default: Disable
Setting range: Disable/Enable
4. Confirm the setting by pressing the navigation wheel again.

T. INDOOR DELAY

In this menu the time delay for how long the indoor temperature must be equal or higher than the indoor setpoint before stopping the circulation pump, and/or closing the mixing valve, in the zone is set.

This menu is only shown if **Shut Off Indoor Temp.** is enabled.

To set the delay:

1. Select **T. Indoor Delay**.
2. Press the navigation wheel to confirm selection.
3. Set the value.
Default: 0 h
Setting range: 0 – 5 h, 1 h increments
4. Confirm the setting by pressing the navigation wheel again.

COOLING

This menu enables access to seasonal shut off settings in the zone, while in cooling mode.

This menu is only shown if one of the following requirements are met:

- **System Type** is set to **2 Pipe**.
- **System Type** is set to **4 Pipe**, and **Z1&2 Operation Mode** is set to **Only Cooling** or **Heating And Cooling**.

MENU TREE*

Cooling	
	Pump Stop
	Valve Close
	T. Outdoor Setpoint
	T. Outdoor Delay

* Parts of the menu tree may only be visible in the Move PRO controller depending on its current configuration.

PUMP STOP

In this menu a function to stop the circulation pump, when requirements are met, is enabled.

To enable the function:

1. Select **Pump Stop**.
2. Press the navigation wheel to confirm selection.
3. Select **Enable**.
Default: Disable
Setting range: Disable/Enable
4. Confirm the setting by pressing the navigation wheel again.

VALVE CLOSE

In this menu a function to close the mixing valve, when requirements are met, is enabled.

To enable the function:

1. Select **Valve Close**.
2. Press the navigation wheel to confirm selection.
3. Select **Enable**.

Default: Disable

Setting range: Disable/Enable

4. Confirm the setting by pressing the navigation wheel again.

T. OUTDOOR SETPOINT

In this menu the outdoor temperature setpoint for stopping the circulation pump, and/or closing the mixing valve, in the zone is set.

To set an outdoor temperature setpoint:

1. Select **T Outdoor Setpoint**.
2. Press the navigation wheel to confirm selection.
3. Select **Enable**.

Default: 17.0 °C

Setting range: 0.0 – 40.0 °C, 0.1 °C increments

4. Confirm the setting by pressing the navigation wheel again.

T. OUTDOOR DELAY

In this menu the time delay for how long the outdoor temperature must be equal or higher than **T Outdoor Setpoint** before stopping the circulation pump, and/or closing the mixing valve, in the zone is set.

To set the delay:

1. Select **T. Outdoor Delay**.
2. Press the navigation wheel to confirm selection.
3. Set the value.

Default: 24 h

Setting range: 0 – 24 h, 1 h increments

4. Confirm the setting by pressing the navigation wheel again.

H/C Switchover

This menu enables access to settings related to switching between heating and cooling in the zone.

This menu is only shown if **System Type** is set to **4 Pipe** and **Z1&2 Operation Mode** is set to **Heating And Cooling**.

MENU TREE*

H/C Switchover	H/C Switchover
	Outdoor Trigger Temp.
	Outdoor Trigger Delay
	Indoor Trigger Temp.
	Indoor Trigger Delay.
	Supply Setpoint for HC Switch
	Hysteresis

* Parts of the menu tree may only be visible in the Move PRO controller depending on its current configuration.

H/C SWITCHOVER

In this menu settings for switching the zone between heating and cooling is set.

To select heating/cooling switchover function for the zone:

1. Select **H/C Switchover**.
2. Press the navigation wheel to confirm selection.
3. Select heating/cooling switchover function for the zone.
 - **Indoor and Outdoor** uses the indoor and outdoor temperatures and time delays to switch the zone between heating and cooling.
 - **Supply Water Temp.** uses the supply water temperature and a hysteresis to switch the zone between heating and cooling.
 - **Contact Input** uses an external signal to switch the zone between heating and cooling.
 - **Force Heating** sets the zone in forced heating.
 - **Force Cooling** sets the zone in forced cooling.
4. Confirm the new setting by pressing the navigation wheel again.

OUTDOOR TRIGGER TEMP.

In this menu one of the triggers (outdoor temperature) for switching the zone between heating and cooling is set.



NOTE!

All triggers and time delays must be met for the zone to switch heating/cooling mode.

This menu is only shown if **H/C Switchover** is set to **Indoor and Outdoor**.

To set the outdoor trigger temperature:

1. Select **Outdoor Trigger Temp.**
2. Press the navigation wheel to confirm selection.
3. Set the value.
Default: 20.0 °C
Setting range: 5.0 – 30.0 °C, 0.1 °C increments
4. Confirm the new setting by pressing the navigation wheel again.

OUTDOOR TRIGGER DELAY

In this menu one of the triggers (delay for outdoor temperature) for switching the zone between heating and cooling is set.



NOTE!

All triggers and time delays must be met for the zone to switch heating/cooling mode.

This menu is only shown if **H/C Switchover** is set to **Indoor and Outdoor**.

To set the outdoor trigger delay:

1. Select **Outdoor Trigger Delay.**
2. Press the navigation wheel to confirm selection.
3. Set the value.
Default: 24 h
Setting range: 1 – 48 h, 1 h increments
4. Confirm the new setting by pressing the navigation wheel again.

INDOOR TRIGGER TEMP.

In this menu one of the triggers (indoor temperature) for switching the zone between heating and cooling is set.



NOTE!

All triggers and time delays must be met for the zone to switch heating/cooling mode.

This menu is only shown if **H/C Switchover** is set to **Indoor and Outdoor**.

To set the indoor trigger temperature:

1. Select **Indoor Trigger Temp.**
2. Press the navigation wheel to confirm selection.
3. Set the value.
Default: 22.0 °C
Setting range: 5.0 – 30.0 °C, 0.1 °C increments
4. Confirm the new setting by pressing the navigation wheel again.

INDOOR TRIGGER DELAY

In this menu one of the triggers (delay for indoor temperature) for switching the zone between heating and cooling is set.



NOTE!

All triggers and time delays must be met for the zone to switch heating/cooling mode.

This menu is only shown if **H/C Switchover** is set to **Indoor and Outdoor**.

To set the indoor trigger delay:

1. Select **Indoor Trigger Delay.**
2. Press the navigation wheel to confirm selection.
3. Set the value.
Default: 24 h
Setting range: 1 – 48 h, 1 h increments
4. Confirm the new setting by pressing the navigation wheel again.

SUPPLY SETPOINT FOR HC SWITCH

In this menu the supply temperature setpoint for switching between heating and cooling is set.

The zone switches to heating when the supply temperature is higher than **Supply Setpoint for HC Switch**. The zone switches back when the supply temperature is lower than **Supply Setpoint for HC Switch - Hysteresis**.

The zone switches to cooling when the supply temperature is lower than **Supply Setpoint for HC Switch**. The zone switches back when the supply temperature is lower than **Supply Setpoint for HC Switch + Hysteresis**.



NOTE!

When using this switch mode, the heating/cooling switch is done in the heat pump/chiller. The Move PRO controller switches the operation mode when it detects the change in supply temperature.

No diverting valves are controlled in this mode.

This menu is only shown if **H/C Switchover** is set to **Supply Water Temp.**

To set the supply temperature setpoint for HC switch:

1. Select **Supply Setpoint for HC Switch**.
2. Press the navigation wheel to confirm selection.
3. Set the value.
Default: 18 °C
Setting range: 5 – 30 °C, 1 °C increments
4. Confirm the new setting by pressing the navigation wheel again.

HYSTERESIS

In this menu the hysteresis which is used to switch between heating and cooling using **Supply Setpoint for HC Switch** is set.

To set the hysteresis:

1. Select **Hysteresis**.
2. Press the navigation wheel to confirm selection.
3. Set the value.
Default: 2 °C
Setting range: 0 – 4 °C, 1 °C increments
4. Confirm the new setting by pressing the navigation wheel again.

Condensation Delay

In this menu the condensation delay in the zone is set. If condensation is not detected (by the condensation sensor in the zone) during the time set in the delay, the condensation status (in the zone information menu) switches to **No**.

This menu is only shown if **Condensation Sensor** is enabled in the startup wizard for the zone.

To set the condensation delay:

1. Select **Condensation Delay**.
2. Press the navigation wheel to confirm selection.
3. Set the value.
Default: 10 min
Setting range: 0 – 120 min, 1 min increments
4. Confirm the new setting by pressing the navigation wheel again.

ZONE 2 SETTINGS

In this menu parameter settings for zone 2 can be set or changed.

Menu tree*

Zone 2 Settings	Supply Temp. Settings
	Heating Indoor Temp. Settings
	DHW Circ Return Settings
	Conf. - ECO
	Heating Curve
	Cooling Curve
	Manual Operation
	Pump
	Mixing Valve
	Dehumidifier Control
	Seasonal Shut Off
	H/C Switchover
	Condensation Delay

* Parts of the menu tree may only be visible in the Move PRO controller depending on its current configuration.

Supply Temp. Settings

This menu enables access to settings related to the supply temperature in the zone.

MENU TREE*

Supply Temp. Settings	Heating
	Cooling
	DHW Supply Setpoint
	Overheating alarm limit
	Overheating alarm delay
	Deviation alarm limit
	Deviation alarm delay

* Parts of the menu tree may only be visible in the Move PRO controller depending on its current configuration.

HEATING

This menu enables access to settings related to the heating supply temperature in the zone.

This menu is only shown if one of the following requirements are met:

- **System Type** is set to **2 Pipe, Indoor Cooling Only** is set to **No**, and **Zone Setup** is set to **Stand Alone Control** or **Smatrix Base PRO** for the zone.
- **System Type** is set to **4 Pipe, Z1&2 Operation Mode** is set to **Only Heating** or **Heating And Cooling**, and **Zone Setup** is set to **Stand Alone Control** or **Smatrix Base PRO** for the zone.

MENU TREE

Heating	Calculated Supply Setpoint
	Heating Min. Supply Temp.
	Heating Max. Supply Temp.
	Deviation alarm limit
	Deviation alarm delay

CALCULATED SUPPLY SETPOINT

In this menu the calculated supply setpoint for the zone can be overridden. This temperature is used as setpoint for the supply temperature.

To override the calculated supply setpoint:

1. Select **Calculated supply setpoint**.
2. Press the navigation wheel to confirm selection.
3. Select **Manual**.
4. Set the override value.
Setting range: -5.0 – 70.0 °C, 0.1 °C increments
5. Confirm the new setting by pressing the navigation wheel again.

HEATING MIN. SUPPLY TEMP.

In this menu the minimum allowed supply temperature for the zone can be set. The supply temperature is not allowed to fall below this value.

To set the minimum allowed supply temperature:

1. Select **Heating Min. supply temp.**
2. Press the navigation wheel to confirm selection.
3. Set the value.
Default: 15.0 °C
Setting range: 5.0 – 35.0 °C (or max. supply temp), 0.1 °C increments
4. Confirm the new setting by pressing the navigation wheel again.

HEATING MAX. SUPPLY TEMP.

In this menu the maximum allowed supply temperature for the zone can be set. The supply temperature is not allowed to rise above this value.

To set the maximum allowed supply temperature:

1. Select **Heating Max. supply temp.**
2. Press the navigation wheel to confirm selection.
3. Set the value.
Default: 70.0 °C
Setting range: 5.0 (or min. supply temp) – 90.0 °C, 0.1 °C increments
4. Confirm the new setting by pressing the navigation wheel again.

DEVIATION ALARM LIMIT

In this menu the deviation alarm limit for the supply temperature in the zone is set. If the difference between the measured and the calculated supply temperatures are higher than the set limit during the time set in **Deviation alarm delay**, the alarm is triggered.

To set the deviation alarm limit:

1. Select **Deviation alarm limit.**
2. Press the navigation wheel to confirm selection.
3. Set the value.
Default: 10.0 °C
Setting range: 0.0 – 50.0 °C, 0.1 °C increments
4. Confirm the new setting by pressing the navigation wheel again.

DEVIATION ALARM DELAY

In this menu the deviation alarm delay for the deviation alarm limit in the zone is set. If the difference between the measured and the calculated supply temperatures are higher than **Deviation alarm limit** during the set delay, the alarm is triggered.

To set the deviation alarm delay:

1. Select **Deviation alarm delay.**
2. Press the navigation wheel to confirm selection.
3. Set the value.
Default: 5 min
Setting range: 0 – 30 min, 1 min increments
4. Confirm the new setting by pressing the navigation wheel again.

COOLING

This menu enables access to settings related to the cooling supply temperature in the zone.

This menu is only shown if one of the following requirements are met:

- **System Type** is set to **2 Pipe**, and **Zone Setup** is set to **Stand Alone Control** or **Smatrix Base PRO** for the zone.
- **System Type** is set to **4 Pipe, Z1&2 Operation Mode** is set to **Only Cooling** or **Heating And Cooling**, and **Zone Setup** is set to **Stand Alone Control** or **Smatrix Base PRO** for the zone.

MENU TREE

Cooling	
	Calculated Supply Setpoint
	Cooling Min. Supply Temp.
	Cooling Max. Supply Temp.
	Dew Point Margin
	Dew Point Offset

CALCULATED SUPPLY SETPOINT

In this menu the calculated supply setpoint for the zone can be overridden. This temperature is used as setpoint for the supply temperature.

To override the calculated supply setpoint:

1. Select **Calculated supply setpoint**.
2. Press the navigation wheel to confirm selection.
3. Select **Manual**.
4. Set the override value.
Setting range: -5.0 – 70.0 °C, 0.1 °C increments
5. Confirm the new setting by pressing the navigation wheel again.

COOLING MIN. SUPPLY TEMP.

In this menu the minimum allowed supply temperature for the zone can be set. The supply temperature is not allowed to fall below this value.

To set the minimum allowed supply temperature:

1. Select **Cooling Min. supply temp.**
2. Press the navigation wheel to confirm selection.
3. Set the value.
Default: 8.0 °C
Setting range: 5.0 – 40.0 °C (or max. supply temp), 0.1 °C increments
4. Confirm the new setting by pressing the navigation wheel again.

COOLING MAX. SUPPLY TEMP.

In this menu the maximum allowed supply temperature for the zone can be set. The supply temperature is not allowed to rise above this value.

To set the maximum allowed supply temperature:

1. Select **Cooling Max. supply temp.**
2. Press the navigation wheel to confirm selection.
3. Set the value.
Default: 25.0 °C
Setting range: 5.0 (or min. supply temp) – 40.0 °C, 0.1 °C increments
4. Confirm the new setting by pressing the navigation wheel again.

DEW POINT MARGIN

In this menu the dew point margin for the zone can be set. The dew point temperature is calculated using the current room temperature and relative humidity.

When the calculated supply temperature is lower than the dew point temperature + **Dew Point Offset** this value is added to the calculated supply temperature.

To set the dew point margin:

1. Select **Dew Point Margin**.
2. Press the navigation wheel to confirm selection.
3. Set the value.
Default: 4.0 °C
Setting range: -1.0 – 10.0 °C
4. Confirm the new setting by pressing the navigation wheel again.

DEW POINT OFFSET

In this menu the dew point offset for the zone can be set. The dew point temperature is calculated using the current room temperature and relative humidity.

The offset is used together with the dew point temperature to decide when to increase the calculated supply temperature with the value set in **Dew Point Margin**.

To set the dew point offset:

1. Select **Dew Point Offset**.
2. Press the navigation wheel to confirm selection.
3. Set the value.
Default: 1.0 °C
Setting range: 0.0 – 4.0 °C
4. Confirm the new setting by pressing the navigation wheel again.

DHW SUPPLY SETPOINT

In this menu the supply temperature setpoint for domestic hot water production is set.

This menu is only shown if **Zone Setup** is set to **Domestic Hot Water** for the zone.

To set the supply temperature setpoint:

1. Select **Supply Setpoint**.
2. Press the navigation wheel to confirm selection.
3. Set the value.
Default: 60.0 °C
Setting range: 5.0 – 95.0 °C, 0.1 °C increments
4. Confirm the new setting by pressing the navigation wheel again.

OVERHEATING ALARM LIMIT

In this menu the overheating alarm limit for domestic hot water production is set. If the supply temperature is higher than the set limit during the time set in **Overheating alarm delay**, the alarm is triggered.

This menu is only shown if **Zone Setup** is set to **Domestic Hot Water** for the zone.

To set the overheating alarm limit:

1. Select **Overheating alarm limit**.
2. Press the navigation wheel to confirm selection.
3. Set the value.
Default: 68.0 °C
Setting range: 65.0 – 120.0 °C, 0.1 °C increments
4. Confirm the new setting by pressing the navigation wheel again.

OVERHEATING ALARM DELAY

In this menu the overheating alarm delay for the overheating alarm limit of the zone is set. If the supply temperature is higher than **Overheating alarm limit**, during the set delay, the alarm is triggered.

This menu is only shown if **Zone Setup** is set to **Domestic Hot Water** for the zone

To set the overheating alarm delay:

1. Select **Overheating alarm delay**.
2. Press the navigation wheel to confirm selection.
3. Set the value.

Default: 10 min

Setting range: 0 – 15 min, 1 min increments

4. Confirm the new setting by pressing the navigation wheel again.

DEVIATION ALARM LIMIT

In this menu the deviation alarm limit for the supply temperature in the zone is set. If the difference between the measured and the calculated supply temperatures are higher than the set limit during the time set in **Deviation alarm delay**, the alarm is triggered.

This menu is only shown if **Zone Setup** is set to **Domestic Hot Water** for the zone.

To set the deviation alarm limit:

1. Select **Deviation alarm limit**.
2. Press the navigation wheel to confirm selection.
3. Set the value.

Default: 10 °C

Setting range: 0.0 – 30.0 °C, 0.1 °C increments

4. Confirm the new setting by pressing the navigation wheel again.

DEVIATION ALARM DELAY

In this menu the deviation alarm delay for the deviation alarm limit in the zone is set. If the difference between the measured and the calculated supply temperatures are higher than **Deviation alarm limit** during the set delay, the alarm is triggered.

This menu is only shown if **Zone Setup** is set to **Domestic Hot Water** for the zone.

To set the deviation alarm delay:

1. Select **Deviation alarm delay**.
2. Press the navigation wheel to confirm selection.
3. Set the value.

Default: 60 seconds

Setting range: 0 – 600 seconds, 1 second increments

4. Confirm the new setting by pressing the navigation wheel again.

Heating Indoor Temp. Settings

This menu enables access to settings related to the room temperature sensor in the zone.

This menu and its submenus are only shown if **Heating Mode** is set to **Outdoor + Indoor comp.** for the zone.

MENU TREE*

Heating Indoor Temp. Settings	
	Indoor Setpoint
	Calculated Indoor Setpoint
	ECO-Comf. Status
	Indoor Setpoint Influence (Lower)
	Indoor Setpoint Influence (Upper)

* Parts of the menu tree may only be visible in the Move PRO controller depending on its current configuration.

INDOOR SETPOINT

In this menu the indoor temperature setpoint for the zone is set.

This information is only shown if **Zone Setup** is set to **Stand Alone Control** for the zone.

To set the indoor temperature setpoint:

1. Select **Indoor Setpoint**.
2. Press the navigation wheel to confirm selection.
3. Set the value.
Default: 21.0 °C
Setting range: 5.0 – 35.0 °C, 0.1 °C increments
4. Confirm the new setting by pressing the navigation wheel again.

CALCULATED INDOOR SETPOINT

This menu shows the calculated indoor setpoint for the zone.

This information is only shown if **Zone Setup** is set to **Stand Alone Control** and if ECO-Comf mode is set to ECO for the zone.

ECO-COMF STATUS

This menu shows if the zone is set in ECO mode.

This information is only shown if ECO-Comf mode is set to ECO for the zone.

INDOOR SETPOINT INFLUENCE (LOWER)

In this menu the indoor setpoint influence (lower) is set. If the measured indoor temperature is higher than the indoor temperature setpoint, the supply temperature setpoint will be lowered using this value.

This menu is used to keep the measured room temperature as close as possible to the indoor temperature setpoint.

NOTE!

If the value is set too high it can lead to the system being unstable and the room temperature will start fluctuating.

To set the indoor setpoint influence (lower):

1. Select **Indoor Setpoint Influence (Lower)**.
2. Press the navigation wheel to confirm selection.
3. Set the value.
Default: 4.0 °C
Setting range: 0.0 – 10.0 °C, 0.1 °C increments
4. Confirm the new setting by pressing the navigation wheel again.

INDOOR SETPOINT INFLUENCE (UPPER)

In this menu the indoor setpoint influence (upper) is set. If the measured indoor temperature is lower than the indoor temperature setpoint, the supply temperature setpoint will be increased using this value.

This menu is used to keep the measured room temperature as close as possible to the indoor temperature setpoint.

NOTE!

If the value is set too high it can lead to the system being unstable and the room temperature will start fluctuating.

To set the indoor setpoint influence (upper):

1. Select **Indoor Setpoint Influence (Upper)**.
2. Press the navigation wheel to confirm selection.
3. Set the value.
Default: 4.0 °C
Setting range: 0.0 – 10.0 °C, 0.1 °C increments
4. Confirm the new setting by pressing the navigation wheel again.

DHW Circ Return Settings

This menu enables access to settings related to the return temperature sensor.

This menu is only shown if **Zone Setup** is set to **Domestic Hot Water** for the zone.

MENU TREE

DHW Circ Return Settings
DHW Circ Return Setpoint
BoostPower

DHW CIRC RETURN SETPOINT

In this menu the return temperature setpoint for the zone is set.

To set the return temperature setpoint:

1. Select **DHW Circ Return Setpoint**.
2. Press the navigation wheel to confirm selection.
3. Set the value.
Default: 50.0 °C
Setting range: 50.0 – 250.0 °C, 0.1 °C increments
4. Confirm the new setting by pressing the navigation wheel again.

BOOSTPOWER

In this menu the boost power for domestic hot water production is set. The parameter is used to adjust the calculated supply temperature, if the difference between the supply and return temperatures is too large.

This menu is only shown if **Zone Setup** is set to **Domestic Hot Water** for the zone.

To set the boost power:

1. Select **BoostPower**.
2. Press the navigation wheel to confirm selection.
3. Set the value.
Default: 60 %
Setting range: 0 – 100 %, 1 % increments
4. Confirm the new setting by pressing the navigation wheel again.

Comf. - ECO

This menu enables access to settings related to the controller Comfort/ECO modes.

This menu and its submenus are only shown if **Zone Setup** is set to **Stand Alone Control** and if **Heating Mode** is set to **Outdoor + Indoor comp.** for the zone.

MENU TREE

Comf. - ECO
ECO Setback
ECO-Comf Status
ECO-Comf Schedule

ECO SETBACK

In this menu the ECO setback temperature is set. The parameter reduces the current setpoint with the set value.

If the setback is set to 0 the zone will resume its normal operation, even if it is set in ECO mode.

To set the ECO setback value:

1. Select **ECO Setback**.
2. Press the navigation wheel to confirm selection.
3. Set the value.
Default: 4.0 °C
Setting range: 0.0 – 10.0 °C, 0.1 °C increments
4. Confirm the new setting by pressing the navigation wheel again.

ECO-COMF STATUS

This menu shows if the zone is set in ECO or Comf (comfort) mode.

ECO-COMF SCHEDULE

In this menu a schedule for switching between Comfort and ECO mode can be created.

The default schedule is set to Comfort mode 24h a day, 7 days a week.



WARNING!

Ensure that different schedules cannot enable ECO and Comf and the same time. This may cause an error where the controller must be reset to factory default values.

To edit/create the ECO-Comf Schedule:

1. Select **ECO-Comf Schedule**.
2. Press the navigation wheel to confirm selection.
The current schedule is showing.
3. Select a day.
4. Press the navigation wheel to confirm selection.
All current schedule settings are shown, each line representing a switch between Comfort and ECO mode. If entering the menu for the first time only one line is present, showing Comf starting at 00:00 every day of the week.
5. Select an existing line to edit or **00:00 Add new** to add a new setting.
6. Select whether to edit the hours, minutes, mode or day of the week.

HOURS:

Set at which hour the mode will start and press the navigation wheel to confirm selection.

MINUTES:

Set at which minute of the hour the mode will start and press the navigation wheel to confirm selection.

MODE:

Select a mode which should start at the set time and press the navigation wheel to confirm selection. Select between **Comf**, **ECO** and **Delete switch time**. **Delete switch time** erases the current line when selecting OK and pressing the navigation wheel.

DAY OF THE WEEK:

Select which days of the week, at the set time the selected mode should start.

7. Select **OK** at the end of the line, when done, and press the navigation wheel to confirm selection.
A new line has been added to the schedule.
8. Redo steps 5 and 6 until the schedule is complete.
9. Press the back button on the controller to exit the schedule setup.

Heating Curve

This menu enables access to heating curve settings for the zone. Settings such as the slope (Setting) and offset of the heating curve.

This menu is only shown if one of the following requirements are met:

- **System Type** is set to **2 Pipe, Indoor Cooling Only** is set to **No**, and **Zone Setup** is set to **Stand Alone Control** or **Smatrix Base PRO** for the zone.
- **System Type** is set to **4 Pipe, Z1&2 Operation Mode** is set to **Only Heating** or **Heating And Cooling**, and **Zone Setup** is set to **Stand Alone Control** or **Smatrix Base PRO** for the zone.

MENU TREE

Heating Curve	
	Setting
	Offset
	Heating Curve

SETTING

In this menu the slope of the heating curve is selected.

To select a heating curve:

1. Select **Setting**.
2. Press the navigation wheel to confirm selection.
3. Set the value.
Default: 0.9
Setting range: 0.1 – 1.6, 0.1 increments
4. Confirm the new setting by pressing the navigation wheel again.

OFFSET

In this menu the the heating curve can be offset. The offset can be used for temporary changes to the heating curve.

To offset the heating curve:

1. Select **Offset**.
2. Press the navigation wheel to confirm selection.
3. Set the value.
Default: 0
Setting range: -8 – 8, 1 increments
4. Confirm the new setting by pressing the navigation wheel again.

HEATING CURVE

This menu shows the heating curve, and max/min supply temperature limits, for the zone.

Cooling Curve

This menu enables access to cooling curve settings for the zone. Settings such as the slope (Setting) and offset of the heating curve.

This menu is only shown if one of the following requirements are met:

- **System Type** is set to **2 Pipe** and **Zone Setup** is set to **Stand Alone Control** or **Smatrix Base PRO** for the zone.
- **System Type** is set to **4 Pipe, Z1&2 Operation Mode** is set to **Only Cooling** or **Heating And Cooling**, and **Zone Setup** is set to **Stand Alone Control** or **Smatrix Base PRO** for the zone.

MENU TREE

Cooling Curve	
	Setting
	Offset
	Cooling Curve

SETTING

In this menu the slope of the heating curve is selected.

To select a heating curve:

1. Select **Setting**.
2. Press the navigation wheel to confirm selection.
3. Set the value.
Default: 0.2
Setting range: 0.1 – 1.6, 0.1 increments
4. Confirm the new setting by pressing the navigation wheel again.

OFFSET

In this menu the the heating curve can be offset. The offset can be used for temporary changes to the heating curve.

To offset the heating curve:

1. Select **Offset**.
2. Press the navigation wheel to confirm selection.
3. Set the value.
Default: 0
Setting range: -8 – 8, 1 increments
4. Confirm the new setting by pressing the navigation wheel again.

COOLING CURVE

This menu shows the cooling curve, and max/min supply temperature limits, for the zone.

Manual Operation

This menu enables access to manual operation mode in the zone.

When manual operation mode is activated, access to manual control (override) of the circulation pump and mixing valve is enabled.

MENU TREE*

Manual Operation	
	Manual Mode
	Pump
	Mixing valve

* Parts of the menu tree may only be visible in the Move PRO controller depending on its current configuration.

To activate manual operation mode:

1. Select **Manual Mode**.
2. Press the navigation wheel to confirm selection.
3. Select **On**.
4. Confirm the new setting by pressing the navigation wheel again.

PUMP

In this menu the pump can be overridden and turned on or off manually.

This menu is only shown if **Zone Setup** is set to **Stand Alone Control** or **Domestic Hot Water, Dehumidifier** is set to **Disable**, and **Manual Mode** is set to **On**.

To override the circulation pump operation:

1. Select **Pump**.
2. Press the navigation wheel to confirm selection.
3. Select **Manual**.
4. Select **On**.
Default: Off
Setting range: Off/On
5. Confirm the new setting by pressing the navigation wheel again.

MIXING VALVE

In this menu the mixing valve can be overridden opened or closed manually.

This menu is only shown if **Manual Mode** is set to **On**.

To override the mixing valve setting:

1. Select **Mixing valve**.
2. Press the navigation wheel to confirm selection.
3. Select **Manual**.
4. Set the override value.
Default: 0 %
Setting range: 0 – 100 %, 1 % increments.
5. Confirm the new setting by pressing the navigation wheel again.

Pump

This menu enables access to pump settings in the zone.

This menu is only shown if **Zone Setup** is set to **Stand Alone Control** or **Domestic Hot Water**, and if **Dehumidifier** is disabled for the zone.

MENU TREE*

Pump	
	Pump Exercise
	Exercise Day of the Week
	Exercise Hour
	Exercise Min

* Parts of the menu tree may only be visible in the Move PRO controller depending on its current configuration.

PUMP EXERCISE

In this menu pump exercise can be activated.

To activate pump exercise:

1. Select **Pump Exercise**.
2. Press the navigation wheel to confirm selection.
3. Select **Pump Exercise**.
Default: No Exercise
Setting range: No Exercise/Pump Exercise
4. Confirm the new setting by pressing the navigation wheel again.

EXERCISE DAY OF THE WEEK

In this menu the day of the week for pump exercise is set.

This menu is only shown if **Pump Exercise** is set to **Pump Exercise**.

To select a day of the week for pump exercise:

1. Select **Exercise Day of the Week**.
2. Press the navigation wheel to confirm selection.
3. Select a day.
Setting range: Monday – Sunday
4. Confirm the setting by pressing the navigation wheel again.

EXERCISE HOUR

In this menu the hour of the day for pump exercise is set.

This menu is only shown if **Pump Exercise** is set to **Pump Exercise**.

To select an hour of the day for pump exercise:

1. Select **Exercise Hour**.
2. Press the navigation wheel to confirm selection.
3. Set the value.
Default: 8 h
Setting range: 0 – 23 h, 1 h increments
4. Confirm the setting by pressing the navigation wheel again.

EXERCISE MIN

In this menu the minute of the hour for pump exercise is set.

This menu is only shown if **Pump Exercise** is set to **Pump Exercise**.

To select a minute of the hour for pump exercise:

1. Select **Exercise Min**.
2. Press the navigation wheel to confirm selection.
3. Set the value.
Default: 0 min
Setting range: 0 – 59 min, 1 min increments
4. Confirm the setting by pressing the navigation wheel again.

Mixing Valve

This menu enables access to mixing valve settings in the zone.

MENU TREE*

Mixing Valve	Heating
	Cooling
	P-area
	I-time
	Actuator running time

* Parts of the menu tree may only be visible in the Move PRO controller depending on its current configuration.

HEATING

This menu enables access to mixing valve settings in the zone while in heating mode.

This menu is only shown if one of the following requirements are met:

- **System Type** is set to **2 Pipe, Indoor Cooling Only** is set to **No**, and **Zone Setup** is set to **Stand Alone Control** or **Smatrix Base PRO** for the zone.
- **System Type** is set to **4 Pipe, Z1&2 Operation Mode** is set to **Only Heating** or **Heating And Cooling**, and **Zone Setup** is set to **Stand Alone Control** or **Smatrix Base PRO** for the zone.

MENU TREE

Heating	P-area
	I-time
	Actuator running time

P-AREA

In this menu the P-area for the mixing valve regulation is set.

To set the P-area:

1. Select **P-area**.
2. Press the navigation wheel to confirm selection.
3. Set the value.
Default: 140.0 °C
Setting range: 2.0 – 500.0 °C, 0.1 °C increments
4. Confirm the setting by pressing the navigation wheel again.

I-TIME

In this menu the I-time for the mixing valve regulation is set.

To set the I-time:

1. Select **I-time**.
2. Press the navigation wheel to confirm selection.
3. Set the value.
Default: 35 seconds
Setting range: 5 – 300 seconds, 1 second increments
4. Confirm the setting by pressing the navigation wheel again.

ACTUATOR RUNNING TIME

In this menu the actuator running time for the mixing valve regulation is set.

To set the actuator running time:

1. Select **Actuator running time**.
2. Press the navigation wheel to confirm selection.
3. Set the value.
Default: 120 seconds
Setting range: 0 – 500 seconds, 1 second increments
4. Confirm the setting by pressing the navigation wheel again.

COOLING

This menu enables access to mixing valve settings in the zone while in cooling mode.

This menu is only shown if one of the following requirements are met:

- **System Type** is set to **2 Pipe** and **Zone Setup** is set to **Stand Alone Control** or **Smatrix Base PRO** for the zone.
- **System Type** is set to **4 Pipe, Z1&2 Operation Mode** is set to **Only Cooling** or **Heating And Cooling**, and **Zone Setup** is set to **Stand Alone Control** or **Smatrix Base PRO** for the zone.

MENU TREE

Cooling	
	P-area
	I-time
	Actuator running time

P-AREA

In this menu the P-area for the mixing valve regulation is set.

To set the P-area:

1. Select **P-area**.
2. Press the navigation wheel to confirm selection.
3. Set the value.
Default: 200.0 °C
Setting range: 2.0 – 500.0 °C, 0.1 °C increments
4. Confirm the setting by pressing the navigation wheel again.

I-TIME

In this menu the I-time for the mixing valve regulation is set.

To set the I-time:

1. Select **I-time**.
2. Press the navigation wheel to confirm selection.
3. Set the value.
Default: 50 seconds
Setting range: 5 – 300 seconds, 1 second increments
4. Confirm the setting by pressing the navigation wheel again.

ACTUATOR RUNNING TIME

In this menu the actuator running time for the mixing valve regulation is set.

To set the actuator running time:

1. Select **Actuator running time**.
2. Press the navigation wheel to confirm selection.
3. Set the value.
Default: 60 seconds
Setting range: 0 – 500 seconds, 1 second increments
4. Confirm the setting by pressing the navigation wheel again.

P-AREA

In this menu the P-area for the mixing valve regulation is set.

This menu is only shown if **Zone Setup** is set to **Domestic Hot Water** for the zone.

To set the P-area:

1. Select **P-area**.
2. Press the navigation wheel to confirm selection.
3. Set the value.
Default: 70 °C
Setting range: 2.0 – 500.0 °C, 0.1 °C increments
4. Confirm the setting by pressing the navigation wheel again.

I-TIME

In this menu the I-time for the mixing valve regulation is set.

This menu is only shown if **Zone Setup** is set to **Domestic Hot Water** for the zone.

To set the I-time:

1. Select **I-time**.
2. Press the navigation wheel to confirm selection.
3. Set the value.
Default: 18 seconds
Setting range: 5 – 300 seconds, 1 second increments
4. Confirm the setting by pressing the navigation wheel again.

ACTUATOR RUNNING TIME

In this menu the actuator running time for the mixing valve regulation is set.

This menu is only shown if **Zone Setup** is set to **Domestic Hot Water** for the zone.

To set the actuator running time:

1. Select **Actuator running time**.
2. Press the navigation wheel to confirm selection.
3. Set the value.
Default: 60 seconds
Setting range: 0 – 300 seconds, 1 second increments
4. Confirm the setting by pressing the navigation wheel again.

Dehumidifier Control

This menu enables access to dehumidifier settings in the zone.

This menu is only shown if **Dehumidifier Control** is enabled in the startup wizard for the zone.

MENU TREE

Dehumidifier Control
Dew Point Margin
Dead Zone

DEW POINT MARGIN

In this menu the dew point margin, for controlling the dehumidifier, in the zone can be set. The dehumidifier is started when the supply temperature is equal or lower than the dew point temperature + dew point margin. The dehumidifier is shut off when the supply temperature is equal or higher than the dew point temperature + dew point margin + deadzone temperature.

To set the dew point margin:

1. Select **Dehumidifier Margin**.
2. Press the navigation wheel to confirm selection.
3. Set the value.
Default: 4.0 °C
Setting range: -1.0 – 10.0 °C
4. Confirm the new setting by pressing the navigation wheel again.

DEAD ZONE

In this menu the dead zone (hysteresis) for when to shut off the dehumidifier in the zone can be set.

To set the dead zone:

1. Select **Dead Zone**.
2. Press the navigation wheel to confirm selection.
3. Set the value.
Default: 2.0 °C
Setting range: 1.0 – 5.0 °C
4. Confirm the new setting by pressing the navigation wheel again.

Seasonal Shut Off

This menu enables access to seasonal shut off settings in the zone.

This menu is only shown if **Zone Setup** is set to **Stand Alone Control** or **Smatrix Base PRO**.

MENU TREE*

Seasonal Shut Off
Heating
Cooling

* Parts of the menu tree may only be visible in the Move PRO controller depending on its current configuration.

HEATING

This menu enables access to seasonal shut off settings in the zone, while in heating mode.

This menu is only shown if one of the following requirements are met:

- **System Type** is set to **2 Pipe, Indoor Cooling Only** is set to **No**, and **Zone Setup** is set to **Stand Alone Control** or **Smatrix Base PRO** for the zone.
- **System Type** is set to **4 Pipe, Z1&2 Operation Mode** is set to **Only Heating** or **Heating And Cooling**, and **Zone Setup** is set to **Stand Alone Control** or **Smatrix Base PRO** for the zone.

MENU TREE*

Heating
Pump Stop
Valve Close
Shut Off Outdoor Temp.
T. Outdoor Setpoint
T. Outdoor Delay
Shut Off Indoor Temp.
T. Indoor Delay

* Parts of the menu tree may only be visible in the Move PRO controller depending on its current configuration.

PUMP STOP

In this menu a function to stop the circulation pump, when requirements are met, is enabled.

This menu is only shown if **Zone Setup** is set to **Stand Alone Control**, and **Dehumidifier** is set to **Disable**.

To enable the function:

1. Select **Pump Stop**.
2. Press the navigation wheel to confirm selection.
3. Select **Enable**.
Default: Disable
Setting range: Disable/Enable
4. Confirm the setting by pressing the navigation wheel again.

VALVE CLOSE

In this menu a function to close the mixing valve, when requirements are met, is enabled.

To enable the function:

1. Select **Valve Close**.
2. Press the navigation wheel to confirm selection.
3. Select **Enable**.
Default: Disable
Setting range: Disable/Enable
4. Confirm the setting by pressing the navigation wheel again.

SHUT OFF OUTDOOR TEMP.

In this menu the function to stop the circulation pump and/or when to close the mixing valve, at an outdoor temperature setpoint is enabled/disabled for the zone.

This menu is only shown if **Pump Stop** and/or **Valve Close** is enabled.

To set an shut off outdoor temperature:

1. Select **Shut Off Outdoor Temp.**.
2. Press the navigation wheel to confirm selection.
3. Select **Enable**.
Default: Disable
Setting range: Disable/Enable
4. Confirm the setting by pressing the navigation wheel again.

T. OUTDOOR SETPOINT

In this menu the outdoor temperature setpoint for stopping the circulation pump, and/or closing the mixing valve, in the zone is set.

This menu is only shown if **Shut Off Outdoor Temp.** is enabled.

To set an outdoor temperature setpoint:

1. Select **T Outdoor Setpoint**.
2. Press the navigation wheel to confirm selection.
3. Select **Enable**.
Default: 17.0 °C
Setting range: 0.0 – 40.0 °C, 0.1 °C increments
4. Confirm the setting by pressing the navigation wheel again.

T. OUTDOOR DELAY

In this menu the time delay for how long the outdoor temperature must be equal or higher than **T Outdoor Setpoint** before stopping the circulation pump, and/or closing the mixing valve, in the zone is set.

This menu is only shown if **Shut Off Outdoor Temp.** is enabled.

To set the delay:

1. Select **T. Outdoor Delay**.
2. Press the navigation wheel to confirm selection.
3. Set the value.
Default: 24 h
Setting range: 0 – 24 h, 1 h increments
4. Confirm the setting by pressing the navigation wheel again.

SHUT OFF INDOOR TEMP.

In this menu the function to stop the circulation pump, and/or when to close the mixing valve, at an indoor temperature setpoint is enabled/disabled for the zone.

This menu is only shown if **Pump Stop** and/or **Valve Close** is enabled, and if **Heating Mode** is set to **Outdoor + Indoor comp.** for the zone.

To set an shut off outdoor temperature:

1. Select **Shut Off Outdoor Temp.**
2. Press the navigation wheel to confirm selection.
3. Select **Enable**.

Default: Disable

Setting range: Disable/Enable

4. Confirm the setting by pressing the navigation wheel again.

T. INDOOR DELAY

In this menu the time delay for how long the indoor temperature must be equal or higher than the indoor setpoint before stopping the circulation pump, and/or closing the mixing valve, in the zone is set.

This menu is only shown if **Shut Off Indoor Temp.** is enabled.

To set the delay:

1. Select **T. Indoor Delay**.
2. Press the navigation wheel to confirm selection.
3. Set the value.

Default: 0 h

Setting range: 0 – 5 h, 1 h increments

4. Confirm the setting by pressing the navigation wheel again.

COOLING

This menu enables access to seasonal shut off settings in the zone, while in cooling mode.

This menu is only shown if one of the following requirements are met:

- **System Type** is set to **2 Pipe**, and **Zone Setup** is set to **Stand Alone Control** or **Smatrix Base PRO** for the zone..
- **System Type** is set to **4 Pipe, Z1&2 Operation Mode** is set to **Only Cooling** or **Heating And Cooling**, and **Zone Setup** is set to **Stand Alone Control** or **Smatrix Base PRO** for the zone..

MENU TREE*

Cooling	
	Pump Stop
	Valve Close
	T. Outdoor Setpoint
	T. Outdoor Delay

* Parts of the menu tree may only be visible in the Move PRO controller depending on its current configuration.

PUMP STOP

In this menu a function to stop the circulation pump, when requirements are met, is enabled.

To enable the function:

1. Select **Pump Stop**.
2. Press the navigation wheel to confirm selection.
3. Select **Enable**.

Default: Disable

Setting range: Disable/Enable

4. Confirm the setting by pressing the navigation wheel again.

VALVE CLOSE

In this menu a function to close the mixing valve, when requirements are met, is enabled.

To enable the function:

1. Select **Valve Close**.
2. Press the navigation wheel to confirm selection.
3. Select **Enable**.

Default: Disable

Setting range: Disable/Enable

4. Confirm the setting by pressing the navigation wheel again.

T. OUTDOOR SETPOINT

In this menu the outdoor temperature setpoint for stopping the circulation pump, and/or closing the mixing valve, in the zone is set.

To set an outdoor temperature setpoint:

1. Select **T Outdoor Setpoint**.
2. Press the navigation wheel to confirm selection.
3. Select **Enable**.

Default: 17.0 °C

Setting range: 0.0 – 40.0 °C, 0.1 °C increments

4. Confirm the setting by pressing the navigation wheel again.

T. OUTDOOR DELAY

In this menu the time delay for how long the outdoor temperature must be equal or higher than **T Outdoor Setpoint** before stopping the circulation pump, and/or closing the mixing valve, in the zone is set.

To set the delay:

1. Select **T. Outdoor Delay**.
2. Press the navigation wheel to confirm selection.
3. Set the value.

Default: 24 h

Setting range: 0 – 24 h, 1 h increments

4. Confirm the setting by pressing the navigation wheel again.

H/C Switchover

This menu enables access to settings related to switching between heating and cooling in the zone.

This menu is only shown if **System Type** is set to **4 Pipe, Z1&2 Operation Mode** (for Zone 1) is set to **Only Heating** or **Only Cooling** and **Z1&2 Operation Mode** (for Zone 2) is set to **Heating And Cooling**.

MENU TREE*

H/C Switchover	H/C Switchover
	Outdoor Trigger Temp.
	Outdoor Trigger Delay
	Indoor Trigger Temp.
	Indoor Trigger Delay.
	Supply Setpoint for HC Switch
	Hysteresis

* Parts of the menu tree may only be visible in the Move PRO controller depending on its current configuration.

H/C SWITCHOVER

In this menu settings for switching the zone between heating and cooling is set.

To select heating/cooling swithover function for the zone:

1. Select **H/C Switchover**.
2. Press the navigation wheel to confirm selection.
3. Select heating/cooling swithover function for the zone.
 - **Indoor and Outdoor** uses the indoor and outdoor temperatures and time delays to switch the zone between heating and cooling.
 - **Supply Water Temp.** uses the supply water temperature and a hysteresis to switch the zone between heating and cooling.
 - **Contact Input** uses an external signal to switch the zone between heating and cooling.
 - **Force Heating** sets the zone in forced heating.
 - **Force Cooling** sets the zone in forced cooling.
4. Confirm the new setting by pressing the navigation wheel again.

OUTDOOR TRIGGER TEMP.

In this menu one of the triggers (outdoor temperature) for switching the zone between heating and cooling is set.



NOTE!

All triggers and time delays must be met for the zone to switch heating/cooling mode.

This menu is only shown if **H/C Switchover** is set to **Indoor and Outdoor**.

To set the outdoor trigger temperature:

1. Select **Outdoor Trigger Temp.**
2. Press the navigation wheel to confirm selection.
3. Set the value.
Default: 20.0 °C
Setting range: 5.0 – 30.0 °C, 0.1 °C increments
4. Confirm the new setting by pressing the navigation wheel again.

OUTDOOR TRIGGER DELAY

In this menu one of the triggers (delay for outdoor temperature) for switching the zone between heating and cooling is set.



NOTE!

All triggers and time delays must be met for the zone to switch heating/cooling mode.

This menu is only shown if **H/C Switchover** is set to **Indoor and Outdoor**.

To set the outdoor trigger delay:

1. Select **Outdoor Trigger Delay.**
2. Press the navigation wheel to confirm selection.
3. Set the value.
Default: 24 h
Setting range: 1 – 48 h, 1 h increments
4. Confirm the new setting by pressing the navigation wheel again.

INDOOR TRIGGER TEMP.

In this menu one of the triggers (indoor temperature) for switching the zone between heating and cooling is set.



NOTE!

All triggers and time delays must be met for the zone to switch heating/cooling mode.

This menu is only shown if **H/C Switchover** is set to **Indoor and Outdoor**.

To set the indoor trigger temperature:

1. Select **Indoor Trigger Temp.**
2. Press the navigation wheel to confirm selection.
3. Set the value.
Default: 22.0 °C
Setting range: 5.0 – 30.0 °C, 0.1 °C increments
4. Confirm the new setting by pressing the navigation wheel again.

INDOOR TRIGGER DELAY

In this menu one of the triggers (delay for indoor temperature) for switching the zone between heating and cooling is set.



NOTE!

All triggers and time delays must be met for the zone to switch heating/cooling mode.

This menu is only shown if **H/C Switchover** is set to **Indoor and Outdoor**.

To set the indoor trigger delay:

1. Select **Indoor Trigger Delay.**
2. Press the navigation wheel to confirm selection.
3. Set the value.
Default: 24 h
Setting range: 1 – 48 h, 1 h increments
4. Confirm the new setting by pressing the navigation wheel again.

SUPPLY SETPOINT FOR HC SWITCH

In this menu the supply temperature setpoint for switching between heating and cooling is set.

The zone switches to heating when the supply temperature is higher than **Supply Setpoint for HC Switch**. The zone switches back when the supply temperature is lower than **Supply Setpoint for HC Switch - Hysteresis**.

The zone switches to cooling when the supply temperature is lower than **Supply Setpoint for HC Switch**. The zone switches back when the supply temperature is lower than **Supply Setpoint for HC Switch + Hysteresis**.



NOTE!

When using this switch mode, the heating/cooling switch is done in the heat pump/chiller. The Move PRO controller switches the operation mode when it detects the change in supply temperature.

No diverting valves are controlled in this mode.

This menu is only shown if **H/C Switchover** is set to **Supply Water Temp.**

To set the supply temperature setpoint for HC switch:

1. Select **Supply Setpoint for HC Switch**.
2. Press the navigation wheel to confirm selection.
3. Set the value.
Default: 18 °C
Setting range: 5 – 30 °C, 1 °C increments
4. Confirm the new setting by pressing the navigation wheel again.

HYSTERESIS

In this menu the hysteresis which is used to switch between heating and cooling using **Supply Setpoint for HC Switch** is set.

To set the hysteresis:

1. Select **Hysteresis**.
2. Press the navigation wheel to confirm selection.
3. Set the value.
Default: 2 °C
Setting range: 0 – 4 °C, 1 °C increments
4. Confirm the new setting by pressing the navigation wheel again.

Condensation Delay

In this menu the condensation delay in the zone is set. If condensation is not detected (by the condensation sensor in the zone) during the time set in the delay, the condensation status (in the zone information menu) switches to **No**.

This menu is only shown if **Condensation Sensor** is enabled in the startup wizard for the zone.

To set the condensation delay:

1. Select **Condensation Delay**.
2. Press the navigation wheel to confirm selection.
3. Set the value.
Default: 10 min
Setting range: 0 – 120 min, 1 min increments
4. Confirm the new setting by pressing the navigation wheel again.

ZONE 3 SETTINGS

In this menu parameter settings for zone 3 can be set or changed.

Menu tree*

Zone 3 Settings	
	Supply Temp. Settings
	Heating Indoor Temp. Settings
	Conf. - ECO
	Heating Curve
	Cooling Curve
	Meltaway Curve (IDLE Status)
	Return Temperature
	Enter Stop State Conditions
	Enter Idle State Conditions
	Enter Melting State Conditions
	Manual Operation
	Pump
	Mixing Valve
	Dehumidifier Control
	Seasonal Shut Off
	H/C Switchover
	Automatic Freeze Protection
	Condensation Delay

* Parts of the menu tree may only be visible in the Move PRO controller depending on its current configuration.

Supply Temp. Settings

This menu enables access to settings related to the supply temperature in the zone.

MENU TREE*

Supply Temp. Settings	Heating
	Cooling
	Calculated Supply Setpoint
	Melting Supply Setpoint
	Heating Curve Meltaway
	IDLE Supply Setpoint
	Min. Supply Temp. (IDLE Status)
	Max. Supply Temp. (IDLE Status)

* Parts of the menu tree may only be visible in the Move PRO controller depending on its current configuration.

HEATING

This menu enables access to settings related to the heating supply temperature in the zone.

This menu is only shown if one of the following requirements are met:

- **System Type** is set to **2 Pipe, Indoor Cooling Only** is set to **No**, and **Zone Setup** is set to **Stand Alone Control** or **Smatrix Base PRO** for the zone.
- **System Type** is set to **4 Pipe, Z3 Operation Mode** is set to **Only Heating** or **Heating And Cooling**, and **Zone Setup** is set to **Stand Alone Control** or **Smatrix Base PRO** for the zone.

MENU TREE

Heating	Calculated Supply Setpoint
	Heating Min. Supply Temp.
	Heating Max. Supply Temp.
	Deviation alarm limit
	Deviation alarm delay

CALCULATED SUPPLY SETPOINT

In this menu the calculated supply setpoint for the zone can be overridden. This temperature is used as setpoint for the supply temperature.

To override the calculated supply setpoint:

1. Select **Calculated supply setpoint**.
2. Press the navigation wheel to confirm selection.
3. Select **Manual**.
4. Set the override value.
Setting range: -5.0 – 70.0 °C, 0.1 °C increments
5. Confirm the new setting by pressing the navigation wheel again.

HEATING MIN. SUPPLY TEMP.

In this menu the minimum allowed supply temperature for the zone can be set. The supply temperature is not allowed to fall below this value.

To set the minimum allowed supply temperature:

1. Select **Heating Min. supply temp.**
2. Press the navigation wheel to confirm selection.
3. Set the value.
Default: 15.0 °C
Setting range: 5.0 – 35.0 °C (or max. supply temp), 0.1 °C increments
4. Confirm the new setting by pressing the navigation wheel again.

HEATING MAX. SUPPLY TEMP.

In this menu the maximum allowed supply temperature for the zone can be set. The supply temperature is not allowed to rise above this value.

To set the maximum allowed supply temperature:

1. Select **Heating Max. supply temp.**
2. Press the navigation wheel to confirm selection.
3. Set the value.
Default: 70.0 °C
Setting range: 5.0 (or min. supply temp) – 90.0 °C, 0.1 °C increments
4. Confirm the new setting by pressing the navigation wheel again.

DEVIATION ALARM LIMIT

In this menu the deviation alarm limit for the supply temperature in the zone is set. If the difference between the measured and the calculated supply temperatures are higher than the set limit during the time set in **Deviation alarm delay**, the alarm is triggered.

To set the deviation alarm limit:

1. Select **Deviation alarm limit**.
2. Press the navigation wheel to confirm selection.
3. Set the value.
Default: 10.0 °C
Setting range: 0.0 – 50.0 °C, 0.1 °C increments
4. Confirm the new setting by pressing the navigation wheel again.

DEVIATION ALARM DELAY

In this menu the deviation alarm delay for the deviation alarm limit in the zone is set. If the difference between the measured and the calculated supply temperatures are higher than **Deviation alarm limit** during the set delay, the alarm is triggered.

To set the deviation alarm delay:

1. Select **Deviation alarm delay**.
2. Press the navigation wheel to confirm selection.
3. Set the value.
Default: 5 min
Setting range: 0 – 30 min, 1 min increments
4. Confirm the new setting by pressing the navigation wheel again.

COOLING

This menu enables access to settings related to the cooling supply temperature in the zone.

This menu is only shown if one of the following requirements are met:

- **System Type** is set to **2 Pipe**, and **Zone Setup** is set to **Stand Alone Control** or **Smatrix Base PRO** for the zone.
- **System Type** is set to **4 Pipe, Z3 Operation Mode** is set to **Only Cooling** or **Heating And Cooling**, and **Zone Setup** is set to **Stand Alone Control** or **Smatrix Base PRO** for the zone.

MENU TREE

Cooling	Calculated Supply Setpoint
	Cooling Min. Supply Temp.
	Cooling Max. Supply Temp.
	Dew Point Margin
	Dew Point Offset

CALCULATED SUPPLY SETPOINT

In this menu the calculated supply setpoint for the zone can be overridden. This temperature is used as setpoint for the supply temperature.

To override the calculated supply setpoint:

1. Select **Calculated supply setpoint**.
2. Press the navigation wheel to confirm selection.
3. Select **Manual**.
4. Set the override value.
Setting range: -5.0 – 70.0 °C, 0.1 °C increments
5. Confirm the new setting by pressing the navigation wheel again.

COOLING MIN. SUPPLY TEMP.

In this menu the minimum allowed supply temperature for the zone can be set. The supply temperature is not allowed to fall below this value.

To set the minimum allowed supply temperature:

1. Select **Cooling Min. supply temp.**
2. Press the navigation wheel to confirm selection.
3. Set the value.
Default: 8.0 °C
Setting range: 5.0 – 40.0 °C (or max. supply temp), 0.1 °C increments
4. Confirm the new setting by pressing the navigation wheel again.

COOLING MAX. SUPPLY TEMP.

In this menu the maximum allowed supply temperature for the zone can be set. The supply temperature is not allowed to rise above this value.

To set the maximum allowed supply temperature:

1. Select **Cooling Max. supply temp.**
2. Press the navigation wheel to confirm selection.
3. Set the value.
Default: 25.0 °C
Setting range: 5.0 (or min. supply temp) – 40.0 °C, 0.1 °C increments
4. Confirm the new setting by pressing the navigation wheel again.

DEW POINT MARGIN

In this menu the dew point margin for the zone can be set. The dew point temperature is calculated using the current room temperature and relative humidity.

When the calculated supply temperature is lower than the dew point temperature + **Dew Point Offset** this value is added to the calculated supply temperature.

To set the dew point margin:

1. Select **Dew Point Margin.**
2. Press the navigation wheel to confirm selection.
3. Set the value.
Default: 4.0 °C
Setting range: -1.0 – 10.0 °C
4. Confirm the new setting by pressing the navigation wheel again.

DEW POINT OFFSET

In this menu the dew point offset for the zone can be set. The dew point temperature is calculated using the current room temperature and relative humidity.

The offset is used together with the dew point temperature to decide when to increase the calculated supply temperature with the value set in **Dew Point Margin.**

To set the dew point offset:

1. Select **Dew Point Offset.**
2. Press the navigation wheel to confirm selection.
3. Set the value.
Default: 1.0 °C
Setting range: 0.0 – 4.0 °C
4. Confirm the new setting by pressing the navigation wheel again.

CALCULATED SUPPLY SETPOINT

In this menu the calculated supply setpoint for the zone can be overridden. This temperature is used as setpoint for the supply temperature.

This menu is only shown if **Zone Setup** is set to **Meltaway** for the zone.

To override the calculated supply setpoint:

1. Select **Calculated supply setpoint**.
2. Press the navigation wheel to confirm selection.
3. Select **Manual**.
4. Set the override value.
Setting range: -5.0 – 70.0 °C, 0.1 °C increments
5. Confirm the new setting by pressing the navigation wheel again.

MELTING SUPPLY SETPOINT

In this menu the supply temperature setpoint for meltaway in the zone is set.

This menu is only shown if **Zone Setup** is set to **Meltaway** for the zone.

To set the melting supply temperature setpoint:

1. Select **Supply Setpoint**.
2. Press the navigation wheel to confirm selection.
3. Set the value.
Default: 35 °C
Setting range: 5.0 – 50.0 °C, 0.1 °C increments
4. Confirm the new setting by pressing the navigation wheel again.

HEATING CURVE MELTAWAY

In this menu a heating curve for the zone, while meltaway status is **IDLE**, can be enabled.

This menu is only shown if **Zone Setup** is set to **Meltaway** for the zone.

To enable the heating curve:

1. Select **Heating Curve**.
2. Press the navigation wheel to confirm selection.
3. Select **Enable**.
4. Confirm the new setting by pressing the navigation wheel again.

IDLE SUPPLY SETPOINT

In this menu a setpoint for the zone, while meltaway status is **IDLE**, can be set. This temperature is used as setpoint for the supply temperature.

This menu is only shown if **Zone Setup** is set to **Meltaway** for the zone.

To set the **IDLE** supply setpoint:

1. Select **IDLE supply setpoint**.
2. Press the navigation wheel to confirm selection.
3. Set the override value.
Default: 8.0 °C
Setting range: 1.0 – 15.0 °C, 0.1 °C increments
4. Confirm the new setting by pressing the navigation wheel again.

MIN. SUPPLY TEMP. (IDLE STATUS)

In this menu the minimum available supply temperature for the zone, while meltaway status is **IDLE**, can be set. The supply temperature is not allowed to fall below this value.

This menu is only shown if **Zone Setup** is set to **Meltaway** for the zone.

To set the minimum allowed supply temperature:

1. Select **Min. supply temp.**
2. Press the navigation wheel to confirm selection.
3. Set the value.
Default: 5.0 °C
Setting range: 0.0 – 25.0 °C, 0.1 °C increments
4. Confirm the new setting by pressing the navigation wheel again.

MAX. SUPPLY TEMP. (IDLE STATUS)

In this menu the maximum available supply temperature for the zone, while meltaway status is **IDLE**, can be set. The supply temperature is not allowed to rise above this value.

This menu is only shown if **Zone Setup** is set to **Meltaway** for the zone.

To set the minimum allowed supply temperature:

1. Select **Max. supply temp.**
2. Press the navigation wheel to confirm selection.
3. Set the value.
Default: 15.0 °C
Setting range: 0.0 – 70.0 °C, 0.1 °C increments
4. Confirm the new setting by pressing the navigation wheel again.

Heating Indoor Temp. Settings

This menu enables access to settings related to the room temperature sensor in the zone.

This menu and its submenus are only shown if **Heating Mode** is set to **Outdoor + Indoor comp.**

MENU TREE*

Heating Indoor Temp. Settings	
	Indoor Setpoint
	Calculated Indoor Setpoint
	ECO-Comf. Status
	Indoor Setpoint Influence (Lower)
	Indoor Setpoint Influence (Upper)

* Parts of the menu tree may only be visible in the Move PRO controller depending on its current configuration.

INDOOR SETPOINT

In this menu the indoor temperature setpoint for the zone is set.

This information is only shown if **Zone Setup** is set to **Stand Alone Control** for the zone.

To set the indoor temperature setpoint:

1. Select **Indoor Setpoint.**
2. Press the navigation wheel to confirm selection.
3. Set the value.
Default: 21.0 °C
Setting range: 5.0 – 35.0 °C, 0.1 °C increments
4. Confirm the new setting by pressing the navigation wheel again.

CALCULATED INDOOR SETPOINT

This menu shows the calculated indoor setpoint for the zone.

This information is only shown if **Zone Setup** is set to **Stand Alone Control** and if ECO-Comf mode is set to ECO for the zone.

ECO-COMF STATUS

This menu shows if the zone is set in ECO mode.

This information is only shown if ECO-Comf mode is set to ECO for the zone.

INDOOR SETPOINT INFLUENCE (LOWER)

In this menu the indoor setpoint influence (lower) is set. If the measured indoor temperature is higher than the indoor temperature setpoint, the supply temperature setpoint will be lowered using this value.

This menu is used to keep the measured room temperature as close as possible to the indoor temperature setpoint.



NOTE!

If the value is set too high it can lead to the system being unstable and the room temperature will start fluctuating.

To set the indoor setpoint influence (lower):

1. Select **Indoor Setpoint Influence (Lower)**.
2. Press the navigation wheel to confirm selection.
3. Set the value.
Default: 4.0 °C
Setting range: 0.0 – 10.0 °C, 0.1 °C increments
4. Confirm the new setting by pressing the navigation wheel again.

INDOOR SETPOINT INFLUENCE (UPPER)

In this menu the indoor setpoint influence (upper) is set. If the measured indoor temperature is lower than the indoor temperature setpoint, the supply temperature setpoint will be increased using this value.

This menu is used to keep the measured room temperature as close as possible to the indoor temperature setpoint.



NOTE!

If the value is set too high it can lead to the system being unstable and the room temperature will start fluctuating.

To set the indoor setpoint influence (upper):

1. Select **Indoor Setpoint Influence (Upper)**.
2. Press the navigation wheel to confirm selection.
3. Set the value.
Default: 4.0 °C
Setting range: 0.0 – 10.0 °C, 0.1 °C increments
4. Confirm the new setting by pressing the navigation wheel again.

Comf. - ECO

This menu enables access to settings related to the controller Comfort/ECO modes.

This menu and its submenus are only shown if **Zone Setup** is set to **Stand Alone Control** and if **Heating Mode** is set to **Outdoor + Indoor comp.** for the zone.

MENU TREE

Comf. - ECO	
	ECO Setback
	ECO-Comf Status
	ECO-Comf Schedule

ECO SETBACK

In this menu the ECO setback temperature is set. The parameter reduces the current setpoint with the set value.

If the setback is set to 0 the zone will resume its normal operation, even if it is set in ECO mode.

To set the ECO setback value:

1. Select **ECO Setback**.
2. Press the navigation wheel to confirm selection.
3. Set the value.
Default: 4.0 °C
Setting range: 0.0 – 10.0 °C, 0.1 °C increments
4. Confirm the new setting by pressing the navigation wheel again.

ECO-COMF STATUS

This menu shows if the zone is set in ECO or Comf (comfort) mode.

ECO-COMF SCHEDULE

In this menu a schedule for switching between Comfort and ECO mode can be created.

The default schedule is set to Comfort mode 24h a day, 7 days a week.



WARNING!

Ensure that different schedules cannot enable ECO and Comf and the same time. This may cause an error where the controller must be reset to factory default values.

To edit/create the ECO-Comf Schedule:

1. Select **ECO-Comf Schedule**.
2. Press the navigation wheel to confirm selection.
The current schedule is showing.
3. Select a day.
4. Press the navigation wheel to confirm selection.
All current schedule settings are shown, each line representing a switch between Comfort and ECO mode. If entering the menu for the first time only one line is present, showing Comf starting at 00:00 every day of the week.
5. Select an existing line to edit or **00:00 Add new** to add a new setting.
6. Select whether to edit the hours, minutes, mode or day of the week.

HOURS:

Set at which hour the mode will start and press the navigation wheel to confirm selection.

MINUTES:

Set at which minute of the hour the mode will start and press the navigation wheel to confirm selection.

MODE:

Select a mode which should start at the set time and press the navigation wheel to confirm selection. Select between **Comf**, **ECO** and **Delete switch time**. **Delete switch time** erases the current line when selecting OK and pressing the navigation wheel.

DAY OF THE WEEK:

Select which days of the week, at the set time the selected mode should start.

7. Select **OK** at the end of the line, when done, and press the navigation wheel to confirm selection.
A new line has been added to the schedule.
8. Redo steps 5 and 6 until the schedule is complete.
9. Press the back button on the controller to exit the schedule setup.

Heating Curve

This menu enables access to heating curve settings for the zone. Settings such as the slope (Setting) and offset of the heating curve.

This menu is only shown if one of the following requirements are met:

- **System Type** is set to **2 Pipe, Indoor Cooling Only** is set to **No**, and **Zone Setup** is set to **Stand Alone Control** or **Smatrix Base PRO** for the zone.
- **System Type** is set to **4 Pipe, Z1&2 Operation Mode** is set to **Only Heating** or **Heating And Cooling**, and **Zone Setup** is set to **Stand Alone Control** or **Smatrix Base PRO** for the zone.

MENU TREE

Heating Curve	
	Setting
	Offset
	Heating Curve

SETTING

In this menu the slope of the heating curve is selected.

To select a heating curve:

1. Select **Setting**.
2. Press the navigation wheel to confirm selection.
3. Set the value.
Default: 0.9
Setting range: 0.1 – 1.6, 0.1 increments
4. Confirm the new setting by pressing the navigation wheel again.

OFFSET

In this menu the the heating curve can be offset. The offset can be used for temporary changes to the heating curve.

To offset the heating curve:

1. Select **Offset**.
2. Press the navigation wheel to confirm selection.
3. Set the value.
Default: 0
Setting range: -8 – 8, 1 increments
4. Confirm the new setting by pressing the navigation wheel again.

HEATING CURVE

This menu shows the heating curve, and max/min supply temperature limits, for the zone.

Cooling Curve

This menu enables access to cooling curve settings for the zone. Settings such as the slope (Setting) and offset of the heating curve.

This menu is only shown if one of the following requirements are met:

- **System Type** is set to **2 Pipe** and **Zone Setup** is set to **Stand Alone Control** or **Smatrix Base PRO** for the zone.
- **System Type** is set to **4 Pipe, Z1&2 Operation Mode** is set to **Only Cooling** or **Heating And Cooling**, and **Zone Setup** is set to **Stand Alone Control** or **Smatrix Base PRO** for the zone.

MENU TREE

Cooling Curve	
	Setting
	Offset
	Cooling Curve

SETTING

In this menu the slope of the heating curve is selected.

To select a heating curve:

1. Select **Setting**.
2. Press the navigation wheel to confirm selection.
3. Set the value.
Default: 0.2
Setting range: 0.1 – 1.6, 0.1 increments
4. Confirm the new setting by pressing the navigation wheel again.

OFFSET

In this menu the the heating curve can be offset. The offset can be used for temporary changes to the heating curve.

To offset the heating curve:

1. Select **Offset**.
2. Press the navigation wheel to confirm selection.
3. Set the value.
Default: 0
Setting range: -8 – 8, 1 increments
4. Confirm the new setting by pressing the navigation wheel again.

COOLING CURVE

This menu shows the cooling curve, and max/min supply temperature limits, for the zone.

Meltaway Curve (IDLE Status)

This menu enables access to meltaway heating curve settings for the zone while in IDLE status. Settings such as the slope (Setting) and offset of the meltaway heating curve.

This menu is only shown if **Zone Setup** is set to **Meltaway** and if **Heating Curve Meltaway** is enabled for the zone.

MENU TREE

Meltaway Curve (IDLE Status)	
	Setting
	Offset
	Heating Curve

SETTING

In this menu the slope of the meltaway heating curve is selected.

To select a meltaway heating curve:

1. Select **Setting**.
2. Press the navigation wheel to confirm selection.
3. Set the value.
Default: 0.9
Setting range: 0.1 – 1.6, 0.1 increments
4. Confirm the new setting by pressing the navigation wheel again.

OFFSET

In this menu the the meltaway heating curve can be offset. The offset can be used for temporary changes to the heating curve.

To offset the meltaway heating curve:

1. Select **Offset**.
2. Press the navigation wheel to confirm selection.
3. Set the value.
Default: 0
Setting range: -8 – 8, 1 increments
4. Confirm the new setting by pressing the navigation wheel again.

HEATING CURVE

This menu shows the meltaway heating curve, and max/min supply temperature limits, for the zone.

Return Temperature

This menu enables access to settings related to the return temperature sensor.

This menu is only shown if **Zone Setup** is set to **Meltaway** for the zone.

MENU TREE

Return Temperature	
	Max. Supply-Return Diff.

MAX. SUPPLY-RETURN DIFF.

In this menu the maximum difference allowed between the supply and return temperature is set.

To set the return temperature setpoint:

1. Select **Max. Supply-Return Diff.**
2. Press the navigation wheel to confirm selection.
3. Set the value.
Default: 20 °C
Setting range: 0.0 – 80.0 °C, 0.1 °C increments
4. Confirm the new setting by pressing the navigation wheel again.

Enter Stop State Conditions

This menu enables access to parameters deciding when to switch the meltaway state in the zone between IDLE and STOP.

The zone switches from IDLE to STOP state when the measured outdoor temperature is higher than the value set in **Outdoor Temperature**, for the number of days set in **Delay (days)**.

This menu is only shown if **Zone Setup** is set to **Meltaway** for the zone.

MENU TREE

Enter Stop State Conditions	
	Outdoor Temperature
	Delay (days)

OUTDOOR TEMPERATURE

In this menu the outdoor temperature, used to switch meltaway state between IDLE and STOP, is set.

To set the outdoor temperature:

1. Select **Outdoor Temperature**.
2. Press the navigation wheel to confirm selection.
3. Set the value.
Default: 10.0 °C
Setting range: 0.0 – 15.0 °C, 0.1 °C increments
4. Confirm the new setting by pressing the navigation wheel again.

DELAY (DAYS)

In this menu the number of delay days, used to switch meltaway state between IDLE and STOP, is set.

To set the delay:

1. Select **Delay (days)**.
2. Press the navigation wheel to confirm selection.
3. Set the value.
Default: 2 days
Setting range: 0 – 5 days, 1 day increments
4. Confirm the new setting by pressing the navigation wheel again.

Enter Idle State Conditions

This menu enables access to parameters used when to switch the meltaway state in the zone to and from IDLE.

The zone switches from STOP to IDLE state when the measured outdoor temperature is lower than the value set in **Outdoor Temperature**, for the number of hours set in **Delay (hours)**.

The zone switches from MELTING to IDLE state when no moisture has been detected (for the number of days set in **Delay Surface Dry**), when the outdoor temperature is higher than the value set in Outdoor Temperature, and when the ground temperature is higher than **Enter Melting State Conditions > Ground Temperature Limit**.

This menu is only shown if **Zone Setup** is set to **Meltaway** for the zone.

MENU TREE

Enter Idle State Conditions	
	Outdoor Temperature
	Delay (hours)
	Delay Surface Dry

OUTDOOR TEMPERATURE

In this menu the outdoor temperature, used to switch meltaway state from STOP or MELTING to IDLE, is set.

To set the outdoor temperature:

1. Select **Outdoor Temperature**.
2. Press the navigation wheel to confirm selection.
3. Set the value.
Default: 5.0 °C
Setting range: 0.0 – 15.0 °C, 0.1 °C increments
4. Confirm the new setting by pressing the navigation wheel again.

DELAY (HOURS)

In this menu the number of delay hours, used to switch meltaway state from STOP to IDLE, is set.

To set the delay:

1. Select **Delay (hours)**.
2. Press the navigation wheel to confirm selection.
3. Set the value.
Default: 1 hour
Setting range: 0 – 24 hours, 1 hour increments
4. Confirm the new setting by pressing the navigation wheel again.

DELAY SURFACE DRY

In this menu the number of delay days, used to switch meltaway state from MELTING to IDLE, is set.

To set the dry surface delay:

1. Select **Delay Surface Dry**.
2. Press the navigation wheel to confirm selection.
3. Set the value.
Default: 0 days
Setting range: 0 – 2 days, 1 day increments
4. Confirm the new setting by pressing the navigation wheel again.

Enter Melting State Conditions

This menu enables access to parameters used when to switch the meltaway state in the zone to and from MELTING. When entering MELTING state the zone stays in that condition until the min limit set in **Min. Time in Melting** is met.

The zone switches from IDLE to MELTING state when one of the following scenarios are met:

1. No ground moisture is detected and the measured ground temperature is lower than than the set limit in **Ground Temperature Limit**.
2. No ground moisture is detected and the measured outdoor temperature is lower than than the set limit in **Outdoor Temperature Low Limit**.

The zone switches from PROTECTION to MELTING when the primary return sensor measures a supply temperature that is higher than PRIMARY RETURN TEMP. HIGH, set in **Automatic Freeze Protection** .

This menu is only shown if **Zone Setup** is set to **Meltaway** for the zone.

MENU TREE

Enter Melting State Conditions	
	Ground Temperature Limit
	Outdoor Temp. Offset
	Outdoor Temperature Low Limit
	Min. Time in Melting

GROUND TEMPERATURE LIMIT

In this menu the ground temperature limit, used to switch meltaway state between IDLE to MELTING , is set.

To set the ground temperature limit:

1. Select **Ground Temperature Limit**.
2. Press the navigation wheel to confirm selection.
3. Select **Low Limit**.
4. Press the navigation wheel to confirm selection.
5. Set the value.
Default: 2 °C
Setting range: 0 – 10 °C, 1 °C increments
6. Confirm the new setting by pressing the navigation wheel again.

OUTDOOR TEMP. OFFSET

In this menu the outdoor temperature offset, used to switch meltaway state from IDLE to MELTING, is set.

To set the outdoor temperature offset:

1. Select **Outdoor Temp. Offset**.
2. Press the navigation wheel to confirm selection.
3. Set the value.
Default: 1 °C
Setting range: -5 – 5 °C, 1 °C increments
4. Confirm the new setting by pressing the navigation wheel again.

OUTDOOR TEMPERATURE LOW LIMIT

In this menu the lower outdoor temperature limit, used to switch meltaway state from IDLE to MELTING, is set.

To set the lower outdoor temperature limit:

1. Select **Outdoor Temperature Low Limit**.
2. Press the navigation wheel to confirm selection.
3. Set the value.
Default: 1 °C
Setting range: -5 – 5 °C, 1 °C increments
4. Confirm the new setting by pressing the navigation wheel again.

MIN. TIME IN MELTING

In this menu the minimum number of hours the zone can be in meltaway state MELTING, is set.

To set the minimum time:

1. Select **Min. Time in Melting**.
2. Press the navigation wheel to confirm selection.
3. Set the value.
Default: 2 hour
Setting range: 0 – 10 hours, 1 hour increments
4. Confirm the new setting by pressing the navigation wheel again.

Manual Operation

This menu enables access to manual operation mode in the zone.

When manual operation mode is activated, access to manual control (override) of the circulation pump and mixing valve is enabled.

Menu tree*

Manual Operation	
	Manual Mode
	Pump
	Mixing valve

* Parts of the menu tree may only be visible in the Move PRO controller depending on its current configuration.

To activate manual operation mode:

1. Select **Manual Mode**.
2. Press the navigation wheel to confirm selection.
3. Select **On**.
4. Confirm the new setting by pressing the navigation wheel again.

PUMP

In this menu the pump can be overridden and turned on or off manually.

This menu is only shown if **Zone Setup** is set to **Stand Alone Control** or **Meltaway**, **Dehumidifier** is set to **Disable**, and **Manual Mode** is set to **On**.

To override the circulation pump operation:

1. Select **Pump**.
2. Press the navigation wheel to confirm selection.
3. Select **Manual**.
4. Select **On**.
Default: Off
Setting range: Off/On
5. Confirm the new setting by pressing the navigation wheel again.

MIXING VALVE

In this menu the mixing valve can be overridden opened or closed manually.

This menu is only shown if **Manual Mode** is set to **On**.

To override the mixing valve setting:

1. Select **Mixing valve**.
2. Press the navigation wheel to confirm selection.
3. Select **Manual**.
4. Set the override value.
Default: 0 %
Setting range: 0 – 100 %, 1 % increments.
5. Confirm the new setting by pressing the navigation wheel again.

Pump

This menu enables access to pump settings in the zone.

This menu is only shown if **Zone Setup** is set to **Stand Alone Control** or **Meltaway**, and if **Dehumidifier** is disabled for the zone.

MENU TREE*

Pump	
	Pump Exercise
	Exercise Day of the Week
	Exercise Hour
	Exercise Min

* Parts of the menu tree may only be visible in the Move PRO controller depending on its current configuration.

PUMP EXERCISE

In this menu pump exercise can be activated.

To activate pump exercise:

1. Select **Pump Exercise**.
2. Press the navigation wheel to confirm selection.
3. Select **Pump Exercise**.
Default: No Exercise
Setting range: No Exercise/Pump Exercise
4. Confirm the new setting by pressing the navigation wheel again.

EXERCISE DAY OF THE WEEK

In this menu the day of the week for pump exercise is set.

This menu is only shown if **Pump Exercise** is set to **Pump Exercise**.

To select a day of the week for pump exercise:

1. Select **Exercise Day of the Week**.
2. Press the navigation wheel to confirm selection.
3. Select a day.
Setting range: Monday – Sunday
4. Confirm the setting by pressing the navigation wheel again.

EXERCISE HOUR

In this menu the hour of the day for pump exercise is set.

This menu is only shown if **Pump Exercise** is set to **Pump Exercise**.

To select an hour of the day for pump exercise:

1. Select **Exercise Hour**.
2. Press the navigation wheel to confirm selection.
3. Set the value.
Default: 8 h
Setting range: 0 – 23 h, 1 h increments
4. Confirm the setting by pressing the navigation wheel again.

EXERCISE MIN

In this menu the minute of the hour for pump exercise is set.

This menu is only shown if **Pump Exercise** is set to **Pump Exercise**.

To select a minute of the hour for pump exercise:

1. Select **Exercise Min**.
2. Press the navigation wheel to confirm selection.
3. Set the value.
Default: 0 min
Setting range: 0 – 59 min, 1 min increments
4. Confirm the setting by pressing the navigation wheel again.

Mixing Valve

This menu enables access to mixing valve settings in the zone.

MENU TREE*

Mixing Valve	Heating
	Cooling
	P-area
	I-time
	Actuator running time

* Parts of the menu tree may only be visible in the Move PRO controller depending on its current configuration.

HEATING

This menu enables access to mixing valve settings in the zone while in heating mode.

This menu is only shown if one of the following requirements are met:

- **System Type** is set to **2 Pipe, Indoor Cooling Only** is set to **No**, and **Zone Setup** is set to **Stand Alone Control** or **Smatrix Base PRO** for the zone.
- **System Type** is set to **4 Pipe, Z1&2 Operation Mode** is set to **Only Heating** or **Heating And Cooling**, and **Zone Setup** is set to **Stand Alone Control** or **Smatrix Base PRO** for the zone.

MENU TREE

Heating	P-area
	I-time
	Actuator running time

P-AREA

In this menu the P-area for the mixing valve regulation is set.

To set the P-area:

1. Select **P-area**.
2. Press the navigation wheel to confirm selection.
3. Set the value.
Default: 140.0 °C
Setting range: 2.0 – 500.0 °C, 0.1 °C increments
4. Confirm the setting by pressing the navigation wheel again.

I-TIME

In this menu the I-time for the mixing valve regulation is set.

To set the I-time:

1. Select **I-time**.
2. Press the navigation wheel to confirm selection.
3. Set the value.
Default: 35 seconds
Setting range: 5 – 300 seconds, 1 second increments
4. Confirm the setting by pressing the navigation wheel again.

ACTUATOR RUNNING TIME

In this menu the actuator running time for the mixing valve regulation is set.

To set the actuator running time:

1. Select **Actuator running time**.
2. Press the navigation wheel to confirm selection.
3. Set the value.
Default: 120 seconds
Setting range: 0 – 500 seconds, 1 second increments
4. Confirm the setting by pressing the navigation wheel again.

COOLING

This menu enables access to mixing valve settings in the zone while in cooling mode.

This menu is only shown if one of the following requirements are met:

- **System Type** is set to **2 Pipe** and **Zone Setup** is set to **Stand Alone Control** or **Smatrix Base PRO** for the zone.
- **System Type** is set to **4 Pipe, Z1&2 Operation Mode** is set to **Only Cooling** or **Heating And Cooling**, and **Zone Setup** is set to **Stand Alone Control** or **Smatrix Base PRO** for the zone.

MENU TREE

Cooling	
	P-area
	I-time
	Actuator running time

P-AREA

In this menu the P-area for the mixing valve regulation is set.

To set the P-area:

1. Select **P-area**.
2. Press the navigation wheel to confirm selection.
3. Set the value.
Default: 200.0 °C
Setting range: 2.0 – 500.0 °C, 0.1 °C increments
4. Confirm the setting by pressing the navigation wheel again.

I-TIME

In this menu the I-time for the mixing valve regulation is set.

To set the I-time:

1. Select **I-time**.
2. Press the navigation wheel to confirm selection.
3. Set the value.
Default: 50 seconds
Setting range: 5 – 300 seconds, 1 second increments
4. Confirm the setting by pressing the navigation wheel again.

ACTUATOR RUNNING TIME

In this menu the actuator running time for the mixing valve regulation is set.

To set the actuator running time:

1. Select **Actuator running time**.
2. Press the navigation wheel to confirm selection.
3. Set the value.
Default: 60 seconds
Setting range: 0 – 500 seconds, 1 second increments
4. Confirm the setting by pressing the navigation wheel again.

P-AREA

In this menu the P-area for the mixing valve regulation is set.

This menu is only shown if **Zone Setup** is set to **Meltaway** for the zone.

To set the P-area:

1. Select **P-area**.
2. Press the navigation wheel to confirm selection.
3. Set the value.
Default: 200.0 °C
Setting range: 2.0 – 500.0 °C, 0.1 °C increments
4. Confirm the setting by pressing the navigation wheel again.

I-TIME

In this menu the I-time for the mixing valve regulation is set.

This menu is only shown if **Zone Setup** is set to **Meltaway** for the zone.

To set the I-time:

1. Select **I-time**.
2. Press the navigation wheel to confirm selection.
3. Set the value.
Default: 50 seconds
Setting range: 5 – 300 seconds, 1 second increments
4. Confirm the setting by pressing the navigation wheel again.

ACTUATOR RUNNING TIME

In this menu the actuator running time for the mixing valve regulation is set.

This menu is only shown if **Zone Setup** is set to **Meltaway** for the zone.

To set the actuator running time:

1. Select **Actuator running time**.
2. Press the navigation wheel to confirm selection.
3. Set the value.
Default: 60 seconds
Setting range: 0 – 500 seconds, 1 second increments
4. Confirm the setting by pressing the navigation wheel again.

Dehumidifier Control

This menu enables access to dehumidifier settings in the zone.

This menu is only shown if **Dehumidifier Control** is enabled in the startup wizard for the zone.

MENU TREE

Dehumidifier Control
Dew Point Margin
Dead Zone

DEW POINT MARGIN

In this menu the dew point margin, for controlling the dehumidifier, in the zone can be set. The dehumidifier is started when the supply temperature is equal or lower than the dew point temperature + dew point margin. The dehumidifier is shut off when the supply temperature is equal or higher than the dew point temperature + dew point margin + deadzone temperature.

To set the dew point margin:

1. Select **Dehumidifier Margin**.
2. Press the navigation wheel to confirm selection.
3. Set the value.
Default: 4.0 °C
Setting range: -1.0 – 10.0 °C
4. Confirm the new setting by pressing the navigation wheel again.

DEAD ZONE

In this menu the dead zone (hysteresis) for when to shut off the dehumidifier in the zone can be set.

To set the dead zone:

1. Select **Dead Zone**.
2. Press the navigation wheel to confirm selection.
3. Set the value.
Default: 2.0 °C
Setting range: 1.0 – 5.0 °C
4. Confirm the new setting by pressing the navigation wheel again.

Seasonal Shut Off

This menu enables access to seasonal shut off settings in the zone.

This menu is only shown if **Zone Setup** is set to **Stand Alone Control** or **Smatrix Base PRO**.

MENU TREE*

Seasonal Shut Off
Heating
Cooling

* Parts of the menu tree may only be visible in the Move PRO controller depending on its current configuration.

HEATING

This menu enables access to seasonal shut off settings in the zone, while in heating mode.

This menu is only shown if one of the following requirements are met:

- **System Type** is set to **2 Pipe, Indoor Cooling Only** is set to **No**, and **Zone Setup** is set to **Stand Alone Control** or **Smatrix Base PRO** for the zone.
- **System Type** is set to **4 Pipe, Z1&2 Operation Mode** is set to **Only Heating** or **Heating And Cooling**, and **Zone Setup** is set to **Stand Alone Control** or **Smatrix Base PRO** for the zone.

MENU TREE*

Heating
Pump Stop
Valve Close
Shut Off Outdoor Temp.
T. Outdoor Setpoint
T. Outdoor Delay
Shut Off Indoor Temp.
T. Indoor Delay

* Parts of the menu tree may only be visible in the Move PRO controller depending on its current configuration.

PUMP STOP

In this menu a function to stop the circulation pump, when requirements are met, is enabled.

This menu is only shown if **Zone Setup** is set to **Stand Alone Control**, and **Dehumidifier** is set to **Disable**.

To enable the function:

1. Select **Pump Stop**.
2. Press the navigation wheel to confirm selection.
3. Select **Enable**.
Default: Disable
Setting range: Disable/Enable
4. Confirm the setting by pressing the navigation wheel again.

VALVE CLOSE

In this menu a function to close the mixing valve, when requirements are met, is enabled.

To enable the function:

1. Select **Valve Close**.
2. Press the navigation wheel to confirm selection.
3. Select **Enable**.
Default: Disable
Setting range: Disable/Enable
4. Confirm the setting by pressing the navigation wheel again.

SHUT OFF OUTDOOR TEMP.

In this menu the function to stop the circulation pump and/or when to close the mixing valve, at an outdoor temperature setpoint is enabled/disabled for the zone.

This menu is only shown if **Pump Stop** and/or **Valve Close** is enabled.

To set an shut off outdoor temperature:

1. Select **Shut Off Outdoor Temp.**.
2. Press the navigation wheel to confirm selection.
3. Select **Enable**.
Default: Disable
Setting range: Disable/Enable
4. Confirm the setting by pressing the navigation wheel again.

T. OUTDOOR SETPOINT

In this menu the outdoor temperature setpoint for stopping the circulation pump, and/or closing the mixing valve, in the zone is set.

This menu is only shown if **Shut Off Outdoor Temp.** is enabled.

To set an outdoor temperature setpoint:

1. Select **T Outdoor Setpoint**.
2. Press the navigation wheel to confirm selection.
3. Select **Enable**.
Default: 17.0 °C
Setting range: 0.0 – 40.0 °C, 0.1 °C increments
4. Confirm the setting by pressing the navigation wheel again.

T. OUTDOOR DELAY

In this menu the time delay for how long the outdoor temperature must be equal or higher than **T Outdoor Setpoint** before stopping the circulation pump, and/or closing the mixing valve, in the zone is set.

This menu is only shown if **Shut Off Outdoor Temp.** is enabled.

To set the delay:

1. Select **T. Outdoor Delay**.
2. Press the navigation wheel to confirm selection.
3. Set the value.
Default: 24 h
Setting range: 0 – 24 h, 1 h increments
4. Confirm the setting by pressing the navigation wheel again.

SHUT OFF INDOOR TEMP.

In this menu the function to stop the circulation pump, and/or when to close the mixing valve, at an indoor temperature setpoint is enabled/disabled for the zone.

This menu is only shown if **Pump Stop** and/or **Valve Close** is enabled, and if **Heating Mode** is set to **Outdoor + Indoor comp.** for the zone.

To set an shut off outdoor temperature:

1. Select **Shut Off Outdoor Temp.**
2. Press the navigation wheel to confirm selection.
3. Select **Enable**.
Default: Disable
Setting range: Disable/Enable
4. Confirm the setting by pressing the navigation wheel again.

T. INDOOR DELAY

In this menu the time delay for how long the indoor temperature must be equal or higher than the indoor setpoint before stopping the circulation pump, and/or closing the mixing valve, in the zone is set.

This menu is only shown if **Shut Off Indoor Temp.** is enabled.

To set the delay:

1. Select **T. Indoor Delay**.
2. Press the navigation wheel to confirm selection.
3. Set the value.
Default: 0 h
Setting range: 0 – 5 h, 1 h increments
4. Confirm the setting by pressing the navigation wheel again.

COOLING

This menu enables access to seasonal shut off settings in the zone, while in cooling mode.

This menu is only shown if one of the following requirements are met:

- **System Type** is set to **2 Pipe**, and **Zone Setup** is set to **Stand Alone Control** or **Smatrix Base PRO** for the zone..
- **System Type** is set to **4 Pipe, Z1&2 Operation Mode** is set to **Only Cooling** or **Heating And Cooling**, and **Zone Setup** is set to **Stand Alone Control** or **Smatrix Base PRO** for the zone..

MENU TREE*

Cooling	
	Pump Stop
	Valve Close
	T. Outdoor Setpoint
	T. Outdoor Delay

* Parts of the menu tree may only be visible in the Move PRO controller depending on its current configuration.

PUMP STOP

In this menu a function to stop the circulation pump, when requirements are met, is enabled.

To enable the function:

1. Select **Pump Stop**.
2. Press the navigation wheel to confirm selection.
3. Select **Enable**.
Default: Disable
Setting range: Disable/Enable
4. Confirm the setting by pressing the navigation wheel again.

VALVE CLOSE

In this menu a function to close the mixing valve, when requirements are met, is enabled.

To enable the function:

1. Select **Valve Close**.
2. Press the navigation wheel to confirm selection.
3. Select **Enable**.

Default: Disable

Setting range: Disable/Enable

4. Confirm the setting by pressing the navigation wheel again.

T. OUTDOOR SETPOINT

In this menu the outdoor temperature setpoint for stopping the circulation pump, and/or closing the mixing valve, in the zone is set.

To set an outdoor temperature setpoint:

1. Select **T Outdoor Setpoint**.
2. Press the navigation wheel to confirm selection.
3. Select **Enable**.

Default: 17.0 °C

Setting range: 0.0 – 40.0 °C, 0.1 °C increments

4. Confirm the setting by pressing the navigation wheel again.

T. OUTDOOR DELAY

In this menu the time delay for how long the outdoor temperature must be equal or higher than **T Outdoor Setpoint** before stopping the circulation pump, and/or closing the mixing valve, in the zone is set.

To set the delay:

1. Select **T. Outdoor Delay**.
2. Press the navigation wheel to confirm selection.
3. Set the value.

Default: 24 h

Setting range: 0 – 24 h, 1 h increments

4. Confirm the setting by pressing the navigation wheel again.

H/C Switchover

This menu enables access to settings related to switching between heating and cooling in the zone.

This menu is only shown if **System Type** is set to **4 Pipe** and **Z3 Operation Mode** is set to **Heating And Cooling**.

MENU TREE*

H/C Switchover	H/C Switchover
	Outdoor Trigger Temp.
	Outdoor Trigger Delay
	Indoor Trigger Temp.
	Indoor Trigger Delay.
	Supply Setpoint for HC Switch
	Hysteresis

* Parts of the menu tree may only be visible in the Move PRO controller depending on its current configuration.

H/C SWITCHOVER

In this menu settings for switching the zone between heating and cooling is set.

To select heating/cooling switchover function for the zone:

1. Select **H/C Switchover**.
2. Press the navigation wheel to confirm selection.
3. Select heating/cooling switchover function for the zone.
 - **Indoor and Outdoor** uses the indoor and outdoor temperatures and time delays to switch the zone between heating and cooling.
 - **Supply Water Temp.** uses the supply water temperature and a hysteresis to switch the zone between heating and cooling.
 - **Contact Input** uses an external signal to switch the zone between heating and cooling.
 - **Force Heating** sets the zone in forced heating.
 - **Force Cooling** sets the zone in forced cooling.
4. Confirm the new setting by pressing the navigation wheel again.

OUTDOOR TRIGGER TEMP.

In this menu one of the triggers (outdoor temperature) for switching the zone between heating and cooling is set.



NOTE!

All triggers and time delays must be met for the zone to switch heating/cooling mode.

This menu is only shown if **H/C Switchover** is set to **Indoor and Outdoor**.

To set the outdoor trigger temperature:

1. Select **Outdoor Trigger Temp.**
2. Press the navigation wheel to confirm selection.
3. Set the value.
Default: 20.0 °C
Setting range: 5.0 – 30.0 °C, 0.1 °C increments
4. Confirm the new setting by pressing the navigation wheel again.

OUTDOOR TRIGGER DELAY

In this menu one of the triggers (delay for outdoor temperature) for switching the zone between heating and cooling is set.



NOTE!

All triggers and time delays must be met for the zone to switch heating/cooling mode.

This menu is only shown if **H/C Switchover** is set to **Indoor and Outdoor**.

To set the outdoor trigger delay:

1. Select **Outdoor Trigger Delay.**
2. Press the navigation wheel to confirm selection.
3. Set the value.
Default: 24 h
Setting range: 1 – 48 h, 1 h increments
4. Confirm the new setting by pressing the navigation wheel again.

INDOOR TRIGGER TEMP.

In this menu one of the triggers (indoor temperature) for switching the zone between heating and cooling is set.



NOTE!

All triggers and time delays must be met for the zone to switch heating/cooling mode.

This menu is only shown if **H/C Switchover** is set to **Indoor and Outdoor**.

To set the indoor trigger temperature:

1. Select **Indoor Trigger Temp.**
2. Press the navigation wheel to confirm selection.
3. Set the value.
Default: 22.0 °C
Setting range: 5.0 – 30.0 °C, 0.1 °C increments
4. Confirm the new setting by pressing the navigation wheel again.

INDOOR TRIGGER DELAY

In this menu one of the triggers (delay for indoor temperature) for switching the zone between heating and cooling is set.



NOTE!

All triggers and time delays must be met for the zone to switch heating/cooling mode.

This menu is only shown if **H/C Switchover** is set to **Indoor and Outdoor**.

To set the indoor trigger delay:

1. Select **Indoor Trigger Delay.**
2. Press the navigation wheel to confirm selection.
3. Set the value.
Default: 24 h
Setting range: 1 – 48 h, 1 h increments
4. Confirm the new setting by pressing the navigation wheel again.

SUPPLY SETPOINT FOR HC SWITCH

In this menu the supply temperature setpoint for switching between heating and cooling is set.

The zone switches to heating when the supply temperature is higher than **Supply Setpoint for HC Switch**. The zone switches back when the supply temperature is lower than **Supply Setpoint for HC Switch - Hysteresis**.

The zone switches to cooling when the supply temperature is lower than **Supply Setpoint for HC Switch**. The zone switches back when the supply temperature is lower than **Supply Setpoint for HC Switch + Hysteresis**.



NOTE!

When using this switch mode, the heating/cooling switch is done in the heat pump/chiller. The Move PRO controller switches the operation mode when it detects the change in supply temperature.

No diverting valves are controlled in this mode.

This menu is only shown if **H/C Switchover** is set to **Supply Water Temp.**

To set the supply temperature setpoint for HC switch:

1. Select **Supply Setpoint for HC Switch**.
2. Press the navigation wheel to confirm selection.
3. Set the value.
Default: 18 °C
Setting range: 5 – 30 °C, 1 °C increments
4. Confirm the new setting by pressing the navigation wheel again.

HYSTERESIS

In this menu the hysteresis which is used to switch between heating and cooling using **Supply Setpoint for HC Switch** is set.

To set the hysteresis:

1. Select **Hysteresis**.
2. Press the navigation wheel to confirm selection.
3. Set the value.
Default: 2 °C
Setting range: 0 – 4 °C, 1 °C increments
4. Confirm the new setting by pressing the navigation wheel again.

Automatic Freeze Protection

This menu decides when to activate automatic freeze protection during meltaway in the zone. The controller will keep the return temperature between the low and high thresholds.

This menu is only shown if **Zone Setup** is set to **Meltaway** for the zone.

MENU TREE

Automatic Freeze Protection	
	Primary return Temp. Low
	Primary return Temp. High

PRIMARY RETURN TEMP. LOW

In this menu the lower threshold is set.

To set the low threshold:

1. Select **Primary return Temp. Low**.
2. Press the navigation wheel to confirm selection.
3. Set a value.
Default: 0.0 °C
Setting range: -5.0 – 5.0 °C, 0.1 °C increments
4. Confirm the setting by pressing the navigation wheel again.

PRIMARY RETURN TEMP. HIGH

In this menu the higher threshold is set.

To set the high threshold:

1. Select **Primary return Temp. High**.
2. Press the navigation wheel to confirm selection.
3. Set a value.
Default: 15.0 °C
Setting range: 15.0 – 45.0 °C, 0.1 °C increments
4. Confirm the setting by pressing the navigation wheel again.

Condensation Delay

In this menu the condensation delay in the zone is set. If condensation is not detected (by the condensation sensor in the zone) during the time set in the delay, the condensation status (in the zone information menu) switches to **No**.

This menu is only shown if **Condensation Sensor** is enabled in the startup wizard for the zone.

To set the condensation delay:

1. Select **Condensation Delay**.
2. Press the navigation wheel to confirm selection.
3. Set the value.
Default: 10 min
Setting range: 0 – 120 min, 1 min increments
4. Confirm the new setting by pressing the navigation wheel again.

H/C SWITCHOVER

This menu enables access to settings related to switching between heating and cooling in the zone.

This menu is only shown if **System Type** is set to **2 Pipe** and one of the zones is not set to **Smatrix Base PRO**.

Menu tree*

H/C Switchover	H/C Switchover
	Outdoor Trigger Temp.
	Outdoor Trigger Delay
	Indoor Trigger Temp.
	Indoor Trigger Delay.
	Supply Setpoint for HC Switch
	Hysteresis

* Parts of the menu tree may only be visible in the Move PRO controller depending on its current configuration.

H/C Switchover

In this menu settings for switching the zone between heating and cooling is set.

To select heating/cooling switchover function for the zone:

1. Select **H/C Switchover**.
2. Press the navigation wheel to confirm selection.
3. Select heating/cooling switchover function for the zone.
 - **Indoor and Outdoor** uses the indoor and outdoor temperatures and time delays to switch the zone between heating and cooling.
 - **Supply Water Temp.** uses the supply water temperature and a hysteresis to switch the zone between heating and cooling.
 - **Contact Input** uses an external signal to switch the zone between heating and cooling.
 - **Force Heating** sets the zone in forced heating.
 - **Force Cooling** sets the zone in forced cooling.
4. Confirm the new setting by pressing the navigation wheel again.

Outdoor Trigger Temp.

In this menu one of the triggers (outdoor temperature) for switching the zone between heating and cooling is set.



NOTE!

All triggers and time delays must be met for the zone to switch heating/cooling mode.

This menu is only shown if **H/C Switchover** is set to **Indoor and Outdoor**.

To set the outdoor trigger temperature:

1. Select **Outdoor Trigger Temp.**
2. Press the navigation wheel to confirm selection.
3. Set the value.
Default: 20.0 °C
Setting range: 5.0 – 30.0 °C, 0.1 °C increments
4. Confirm the new setting by pressing the navigation wheel again.

Outdoor Trigger Delay

In this menu one of the triggers (delay for outdoor temperature) for switching the zone between heating and cooling is set.



NOTE!

All triggers and time delays must be met for the zone to switch heating/cooling mode.

This menu is only shown if **H/C Switchover** is set to **Indoor and Outdoor**.

To set the outdoor trigger delay:

1. Select **Outdoor Trigger Delay.**
2. Press the navigation wheel to confirm selection.
3. Set the value.
Default: 24 h
Setting range: 1 – 48 h, 1 h increments
4. Confirm the new setting by pressing the navigation wheel again.

Indoor Trigger Temp.

In this menu one of the triggers (indoor temperature) for switching the zone between heating and cooling is set.



NOTE!

All triggers and time delays must be met for the zone to switch heating/cooling mode.

This menu is only shown if **H/C Switchover** is set to **Indoor and Outdoor**.

To set the indoor trigger temperature:

1. Select **Indoor Trigger Temp.**
2. Press the navigation wheel to confirm selection.
3. Set the value.
Default: 22.0 °C
Setting range: 5.0 – 30.0 °C, 0.1 °C increments
4. Confirm the new setting by pressing the navigation wheel again.

Indoor Trigger Delay

In this menu one of the triggers (delay for indoor temperature) for switching the zone between heating and cooling is set.



NOTE!

All triggers and time delays must be met for the zone to switch heating/cooling mode.

This menu is only shown if **H/C Switchover** is set to **Indoor and Outdoor**.

To set the indoor trigger delay:

1. Select **Indoor Trigger Delay.**
2. Press the navigation wheel to confirm selection.
3. Set the value.
Default: 24 h
Setting range: 1 – 48 h, 1 h increments
4. Confirm the new setting by pressing the navigation wheel again.

Supply Setpoint for HC Switch

In this menu the supply temperature setpoint for switching between heating and cooling is set.

The zone switches to heating when the supply temperature is higher than **Supply Setpoint for HC Switch**. The zone switches back when the supply temperature is lower than **Supply Setpoint for HC Switch - Hysteresis**.

The zone switches to cooling when the supply temperature is lower than **Supply Setpoint for HC Switch**. The zone switches back when the supply temperature is lower than **Supply Setpoint for HC Switch + Hysteresis**.



NOTE!

When using this switch mode, the heating/cooling switch is done in the heat pump/chiller. The Move PRO controller switches the operation mode when it detects the change in supply temperature.

No diverting valves are controlled in this mode.

This menu is only shown if **H/C Switchover** is set to **Supply Water Temp.**

To set the supply temperature setpoint for HC switch:

1. Select **Supply Setpoint for HC Switch**.
2. Press the navigation wheel to confirm selection.
3. Set the value.
Default: 18 °C
Setting range: 5 – 30 °C, 1 °C increments
4. Confirm the new setting by pressing the navigation wheel again.

Hysteresis

In this menu the hysteresis which is used to switch between heating and cooling using **Supply Setpoint for HC Switch** is set.

To set the hysteresis:

1. Select **Hysteresis**.
2. Press the navigation wheel to confirm selection.
3. Set the value.
Default: 2 °C
Setting range: 0 – 4 °C, 1 °C increments
4. Confirm the new setting by pressing the navigation wheel again.

CONTROLLER SETTINGS

In this menu parameter settings for the controller can be set or changed.

Menu tree

Controller Settings	
	Time
	Date
	Language

Time

In this menu the time of the system is set.

To set the time:

1. Select **Time**.
2. Press the navigation wheel to confirm selection.
3. Set the hours.
4. Press the navigation wheel to confirm selection.
5. Set the minutes.
6. Confirm the setting by pressing the navigation wheel again.

Date

In this menu the date of the system is set.

To set the date:

1. Select **Date**.
2. Press the navigation wheel to confirm selection.
3. Set the day.
4. Press the navigation wheel to confirm selection.
5. Set the month.
6. Press the navigation wheel to confirm selection.
7. Set the year.
8. Confirm the setting by pressing the navigation wheel again.

Language

In this menu the language of the system is set.

To set the language:

1. Select **Language**.
2. Press the navigation wheel to confirm selection.
3. Select a language.
4. Confirm the setting by pressing the navigation wheel again.

7.11 Pre Heating Info

This menu shows information about the system, enabled zones and the controller (when the operating mode is set to **Pre Heating** in the startup wizard).

Menu tree*

Pre Heating Info	
	System information
	Zone 1 Information
	Zone 2 Information
	Zone 3 Information
	Controller Information

* Parts of the menu tree may only be visible in the Move PRO controller depending on its current configuration.

SYSTEM INFORMATION

The system information menu shows the current time and date.

ZONE 1 INFORMATION

This menu shows information about zone 1.

Menu tree

Zone 1 Information	
	Supply temperature
	State
	Time Left

Supply temperature

The current supply temperature is shown. The temperature is measured by the supply temperature sensor wired to the controller.

State

The current pre-heating state (phase) in the zone is shown.

Pre heating is run in three different phases.

Pase 1: The supply temperature setpoint is set to 25 °C for 3 days (can be set in the **Settings** menu).

Pase 2: The supply temperature setpoint is set to maximum allowed calculated setpoint for 4 days (can be set in the **Settings** menu).

Pase 3: The controller enters **Standby** mode until the startup wizard is restarted (**Settings > Installer Settings > Restart wizard**). Frost protection is active during this final phase.

Time Left

The time left of the current pre-heating phase in the zone is shown.

ZONE 2 INFORMATION

This menu shows information about zone 2.

Menu tree

Zone 2 Information	
	Supply temperature
	State
	Time Left

Supply temperature

The current supply temperature is shown. The temperature is measured by the supply temperature sensor wired to the controller.

State

The current pre-heating state (phase) in the zone is shown.

Pre heating is run in three different phases.

Pase 1: The supply temperature setpoint is set to 25 °C for 3 days (can be set in the **Settings** menu).

Pase 2: The supply temperature setpoint is set to maximum allowed calculated setpoint for 4 days (can be set in the **Settings** menu).

Pase 3: The controller enters **Standby** mode until the startup wizard is restarted (**Settings > Installer Settings > Restart wizard**). Frost protection is active during this final phase.

Time Left

The time left of the current pre-heating phase in the zone is shown.

ZONE 3 INFORMATION

This menu shows information about zone 3.

Menu tree

Zone 3 Information	
	Supply temperature
	State
	Time Left

Supply temperature

The current supply temperature is shown. The temperature is measured by the supply temperature sensor wired to the controller.

State

The current pre-heating state (phase) in the zone is shown.

Pre heating is run in three different phases.

Pase 1: The supply temperature setpoint is set to 25 °C for 3 days (can be set in the **Settings** menu).

Pase 2: The supply temperature setpoint is set to maximum allowed calculated setpoint for 4 days (can be set in the **Settings** menu).

Pase 3: The controller enters **Standby** mode until the startup wizard is restarted (**Settings > Installer Settings > Restart wizard**). Frost protection is active during this final phase.

Time Left

The time left of the current pre-heating phase in the zone is shown.

CONTROLLER INFORMATION

This menu shows information about the controller.

Menu tree

Controller Information	
	Language
	About...

Language

This menu show the set display language for the controller.

About...

This menu shows the serial number, software versions, and hardware versions of the controller.

7.12 Pre Heating Settings

In this menu installer settings, enabled zone settings, and controller settings can be changed (when the operating mode is set to **Pre Heating** in the startup wizard).

See section 5.14 *Pre heating concrete slab (DIN 1264-4)* for more information.

Menu tree*

Pre Heating Settings	
	Installer Settings
	Zone 1 Settings
	Zone 2 Settings
	Zone 3 Settings
	Controller Settings

* Parts of the menu tree may only be visible in the Move PRO controller depending on its current configuration.

INSTALLER SETTINGS

In this menu lock codes (to gain access to locked parameter settings) can be set or changed, factory settings can be restored, backup of controller parameter settings can be managed, or the setup wizard can be restarted.

Menu tree

Installer Settings	
	Lock code
	Change lock code
	Display settings
	Restore factory settings
	Restore backup
	New backup
	Restart wizard

Lock code

A lock code can be used to block a user from changing parameter settings. The menu system is fully accessible, but the lock code is required to enter and change parameter settings.

The default lock code is 0000. It is recommended to change this code if using this function.

The controller will stay unlocked until it has been left untouched for about 10 minutes. Then it will lock itself again.

To enable lock code in the controller:

1. Select **Lock code**.
2. Press the navigation wheel to confirm selection.
3. Select **Enable**.
4. Press the navigation wheel to confirm selection.

ENTERING A MENU WHEN LOCK CODE IS ENABLED

To enter a lock code:

1. Select the parameter.
2. Press the navigation wheel to confirm selection.
3. Enter the lock code in the boxes using the navigation wheel.

Turn the navigation wheel to either select a box, or to increase/decrease a value in edit mode.

Press the navigation wheel to enter edit mode or to confirm the new setting.

Default: 0000

4. Confirm the lock code by pressing and holding the navigation wheel for a number of seconds.
5. Change the parameter setting and exit.

Change lock code

The standard lock code which is used to block a user from changing parameter settings, can be changed in this menu.

This menu is only shown when **Lock code** has been enabled in the **Lock code** menu.



NOTE!

If the controller display is already locked, it has to be unlocked before entering the new lock code.

To change the lock code:

1. Select **Change lock code**.
2. Press the navigation wheel to confirm selection.
3. Enter the new lock code in the boxes using the navigation wheel.

Turn the navigation wheel to either select a box, or to increase/decrease a value in edit mode.

Press the navigation wheel to enter edit mode or to confirm the new setting.

Default: 0000

4. Confirm the new lock code by pressing and holding the navigation wheel for about 8 seconds.

Display settings

This menu enables display settings, such as contrast, and it also shows the version number of the display software.

To set the display contrast:

1. Select **Display settings**.
2. Press the navigation wheel to confirm selection.
3. Select **Display contrast**.
4. Press the navigation wheel to confirm selection.
5. Set the display contrast.

Setting range: -50 – 100 %, 1 % increments

6. Press the navigation wheel to confirm selection.

Restore factory settings

This menu enables all parameter settings in the controller to be reset to the factory default settings.

To restore the factory settings:

1. Select **Restore factory settings**.
2. Press the navigation wheel to confirm selection.
3. Select **Yes**.
Setting range: No (default)/Yes
4. Press the navigation wheel to confirm selection.
5. All parameters in the controller are being restored to factory settings.

Restore backup

This menu enables the controller to restore all parameter settings from a previously created backup located on the microSD-card.

To restore from a backup:

1. Make sure the microSD-card with the backup is inserted into the controller.
2. Select **Restore backup**.
3. Press the navigation wheel to confirm selection.
4. Select **Yes**.
Setting range: No (default)/Yes
5. Press the navigation wheel to confirm selection.
6. All parameters in the controller are being restored from backup.

New backup

This menu enables the controller to save a backup of all parameter settings to the microSD-card.

To save from a backup:

1. Make sure a microSD-card, where the backup is to be saved, into the controller.
2. Select **New backup**.
3. Press the navigation wheel to confirm selection.
4. Select **Yes**.
Setting range: No (default)/Yes
5. Press the navigation wheel to confirm selection.
6. All parameters in the controller are being saved to the microSD card.

Restart wizard

This menu enables the controller to restart the setup wizard.

To restart the setup wizard:

1. Select **Restart wizard**.
2. Press the navigation wheel to confirm selection.
3. Select **Yes**.
Setting range: No (default)/Yes
4. Press the navigation wheel to confirm selection.
5. The setup wizard is now being restarted.

ZONE 1 SETTINGS

In this menu parameter settings for zone 1 can be set or changed.

Menu tree

Zone 1 Settings	
	Z1 Max. Calc. Supply Setpoint
	Frost Protection Setpoint
	P-area
	I-time
	Actuator running time

Z1 Max. Calc. Supply Setpoint

In this menu the maximum allowed calculated supply setpoint for the zone can be set.

To set the maximum allowed calculated supply setpoint:

1. Select **Z1 Max. Calc. Supply Setpoint**.
2. Press the navigation wheel to confirm selection.
3. Set the value.
Default: 45.0 °C
Setting range: -5.0 – 70.0 °C, 0.1 °C increments
4. Confirm the new setting by pressing the navigation wheel again.

Frost Protection Setpoint

In this menu the frost protection setpoint (minimum available supply temperature) for the zone can be set. The supply temperature is not allowed to fall below this value.

To set the frost protection setpoint:

1. Select **Frost Protection Setpoint**.
2. Press the navigation wheel to confirm selection.
3. Set the value.
Default: 5.0 °C
Setting range: 5.0 – 20.0 °C (or max. supply temp), 0.1 °C increments
4. Confirm the new setting by pressing the navigation wheel again.

P-area

In this menu the P-area for the mixing valve regulation is set.

To set the P-area:

1. Select **P-area**.
2. Press the navigation wheel to confirm selection.
3. Set the value.
Default: 140.0 °C
Setting range: 2.0 – 500.0 °C, 0.1 °C increments
4. Confirm the setting by pressing the navigation wheel again.

I-time

In this menu the I-time for the mixing valve regulation is set.

To set the I-time:

1. Select **I-time**.
2. Press the navigation wheel to confirm selection.
3. Set the value.
Default: 35 seconds
Setting range: 5 – 300 seconds, 1 second increments
4. Confirm the setting by pressing the navigation wheel again.

Actuator running time

In this menu the actuator running time for the mixing valve regulation is set.

To set the actuator running time:

1. Select **Actuator running time**.
2. Press the navigation wheel to confirm selection.
3. Set the value.
Default: 120 seconds
Setting range: 0 – 500 seconds, 1 second increments
4. Confirm the setting by pressing the navigation wheel again.

ZONE 2 SETTINGS

In this menu parameter settings for zone 2 can be set or changed.

Menu tree

Zone 2 Settings	
	Z2 Max. Calc. Supply Setpoint
	Frost Protection Setpoint
	P-area
	I-time
	Actuator running time

Z2 Max. Calc. Supply Setpoint

In this menu the maximum allowed calculated supply setpoint for the zone can be set.

To set the maximum allowed calculated supply setpoint:

1. Select **Z2 Max. Calc. Supply Setpoint**.
2. Press the navigation wheel to confirm selection.
3. Set the value.
Default: 45.0 °C
Setting range: -5.0 – 70.0 °C, 0.1 °C increments
4. Confirm the new setting by pressing the navigation wheel again.

Frost Protection Setpoint

In this menu the frost protection setpoint (minimum available supply temperature) for the zone can be set. The supply temperature is not allowed to fall below this value.

To set the frost protection setpoint:

1. Select **Frost Protection Setpoint**.
2. Press the navigation wheel to confirm selection.
3. Set the value.
Default: 5.0 °C
Setting range: 5.0 – 20.0 °C (or max. supply temp), 0.1 °C increments
4. Confirm the new setting by pressing the navigation wheel again.

P-area

In this menu the P-area for the mixing valve regulation is set.

To set the P-area:

1. Select **P-area**.
2. Press the navigation wheel to confirm selection.
3. Set the value.
Default: 200.0 °C
Setting range: 2.0 – 500.0 °C, 0.1 °C increments
4. Confirm the setting by pressing the navigation wheel again.

I-time

In this menu the I-time for the mixing valve regulation is set.

To set the I-time:

1. Select **I-time**.
2. Press the navigation wheel to confirm selection.
3. Set the value.
Default: 50 seconds
Setting range: 5 – 300 seconds, 1 second increments
4. Confirm the setting by pressing the navigation wheel again.

Actuator running time

In this menu the actuator running time for the mixing valve regulation is set.

To set the actuator running time:

1. Select **Actuator running time**.
2. Press the navigation wheel to confirm selection.
3. Set the value.
Default: 60 seconds
Setting range: 0 – 500 seconds, 1 second increments
4. Confirm the setting by pressing the navigation wheel again.

ZONE 3 SETTINGS

In this menu parameter settings for zone 3 can be set or changed.

Menu tree

Zone 3 Settings	
	Z3 Max. Calc. Supply Setpoint
	Frost Protection Setpoint
	P-area
	I-time
	Actuator running time

Z3 Max. Calc. Supply Setpoint

In this menu the maximum allowed calculated supply setpoint for the zone can be set.

To set the maximum allowed calculated supply setpoint:

1. Select **Z1 Max. Calc. Supply Setpoint**.
2. Press the navigation wheel to confirm selection.
3. Set the value.
Default: 45.0 °C
Setting range: -5.0 – 70.0 °C, 0.1 °C increments
4. Confirm the new setting by pressing the navigation wheel again.

Frost Protection Setpoint

In this menu the frost protection setpoint (minimum available supply temperature) for the zone can be set. The supply temperature is not allowed to fall below this value.

To set the frost protection setpoint:

1. Select **Frost Protection Setpoint**.
2. Press the navigation wheel to confirm selection.
3. Set the value.
Default: 5.0 °C
Setting range: 5.0 – 20.0 °C (or max. supply temp), 0.1 °C increments
4. Confirm the new setting by pressing the navigation wheel again.

P-area

In this menu the P-area for the mixing valve regulation is set.

To set the P-area:

1. Select **P-area**.
2. Press the navigation wheel to confirm selection.
3. Set the value.
Default: 200.0 °C
Setting range: 2.0 – 500.0 °C, 0.1 °C increments
4. Confirm the setting by pressing the navigation wheel again.

I-time

In this menu the I-time for the mixing valve regulation is set.

To set the I-time:

1. Select **I-time**.
2. Press the navigation wheel to confirm selection.
3. Set the value.
Default: 50 seconds
Setting range: 5 – 300 seconds, 1 second increments
4. Confirm the setting by pressing the navigation wheel again.

Actuator running time

In this menu the actuator running time for the mixing valve regulation is set.

To set the actuator running time:

1. Select **Actuator running time**.
2. Press the navigation wheel to confirm selection.
3. Set the value.
Default: 60 seconds
Setting range: 0 – 500 seconds, 1 second increments
4. Confirm the setting by pressing the navigation wheel again.

CONTROLLER SETTINGS

In this menu parameter settings for the controller can be set or changed.

Menu tree

Controller Settings	
	Time
	Date
	Language
	Operation mode

Time

In this menu the time of the system is set.

To set the time:

1. Select **Time**.
2. Press the navigation wheel to confirm selection.
3. Set the hours.
4. Press the navigation wheel to confirm selection.
5. Set the minutes.
6. Confirm the setting by pressing the navigation wheel again.

Date

In this menu the date of the system is set.

To set the date:

1. Select **Date**.
2. Press the navigation wheel to confirm selection.
3. Set the day.
4. Press the navigation wheel to confirm selection.
5. Set the month.
6. Press the navigation wheel to confirm selection.
7. Set the year.
8. Confirm the setting by pressing the navigation wheel again.

Language

In this menu the language of the system is set.

To set the language:

1. Select **Language**.
2. Press the navigation wheel to confirm selection.
3. Select a language.
4. Confirm the setting by pressing the navigation wheel again.

Operation mode

In this menu the operation mode of the system is set.

This setting is used to change from pre heating to standard mode, when done pre heating.

To set operation mode:

1. Select **Operation mode**.
2. Press the navigation wheel to confirm selection.
3. Select an operation mode.

Standard: This selection will make the controller to restart the startup wizard, after a small delay.

Pre Heating: This selection will make the controller stay in Pre Heating mode.

4. Confirm the setting by pressing the navigation wheel again.

7.13 Menu tree



NOTE!

Parts of the menu tree may only be visible in the Move PRO controller depending on its current configuration.

STANDARD OPERATING MODE

System Overview		
Information	System information	Time
		Date
		Outdoor Temperature
	Zone 1 Information	Zone Setup
		Heating Mode
		Operating Mode
		Supply temperature
		Mixing Valve
		Pump
	Heating	Heating Curve
		Calculated Supply Setpoint
		Indoor temperature
		ECO-Comf Status
	Cooling	Cooling Curve
		Calculated Supply Setpoint
		Condensation
		Relative Humidity
		Dew Point Temperature
		Dehumidifier
	Zone 2 Information	Zone Setup
		Heating Mode
		Operating Mode
		Supply temperature
		Calculated Supply Setpoint
		DHW Circ. Return Temperature
		Mixing Valve
		Pump
	Heating	Heating Curve
		Calculated Supply Setpoint
		Indoor temperature
		ECO-Comf Status

		Cooling	Cooling Curve
			Calculated Supply Setpoint
			Condensation
			Relative Humidity
			Dew Point Temperature
			Dehumidifier
	Zone 3 Information	Zone Setup	
		Heating Mode	
		Operating Mode	
		Supply temperature	
		Calculated Supply Setpoint	
		Indoor temperature	
		Meltaway Curve	
		Return temperature	
		Ground Temperature	
		Ground Moisture	
		Primary Return Temperature	
		Status	
		Mixing Valve	
		Pump	
		Status	
		Heating	Heating Curve
			Calculated Supply Setpoint
			Indoor temperature
			ECO-Comf Status
		Cooling	Cooling Curve
			Calculated Supply Setpoint
			Condensation
			Relative Humidity
			Dew Point Temperature
			Dehumidifier
	Controller Information	Language	
		About...	
Alarms	Active alarms		
	Alarm history		
	Acknowledge all alarms		
	Reset alarm history		

Settings	Installer Settings	T Outdoor Fallback		
		Lock code Change lock code Display settings Restore factory settings Restore backup New backup Restart wizard		
	Zone 1 Settings	Supply Temp. Settings	Heating	Calculated Supply Setpoint
				Heating Min. Supply Temp. Heating Max. Supply Temp. Deviation alarm limit Deviation alarm delay
			Cooling	Calculated Supply Setpoint Cooling Min. Supply Temp. Cooling Max. Supply Temp. Dew Point Margin Dew Point Offset
		Heating Indoor Temp. Settings	Indoor Setpoint	
			Calculated Indoor Setpoint ECO-Comf. Status Indoor Setpoint Influence (Lower) Indoor Setpoint Influence (Upper)	
		Comf. - ECO	ECO Setback	
			ECO-Comf Status ECO-Comf Schedule	
		Heating Curve	Setting	
			Offset Heating Curve	
		Cooling Curve	Setting	
			Offset Cooling Curve	
		Manual Operation	Manual Mode	
			Pump Mixing valve	
		Pump	Pump Exercise	
			Exercise Day of the Week Exercise Hour Exercise Min	

	Mixing Valve	Heating	P-area
			I-time
			Actuator running time
		Cooling	P-area
			I-time
			Actuator running time
	Dehumidifier Control	Dew Point Margin	
		Dead Zone	
	Seasonal Shut Off	Heating	Pump Stop
			Valve Close
			Shut Off Outdoor Temp.
			T. Outdoor Setpoint
			T. Outdoor Delay
			Shut Off Indoor Temp.
			T. Indoor Delay
		Cooling	Pump Stop
			Valve Close
			T. Outdoor Setpoint
			T. Outdoor Delay
	HC Switchover	H/C Switchover	
		Outdoor Trigger Temp.	
		Outdoor Trigger Delay	
		Indoor Trigger Temp.	
		Indoor Trigger Delay.	
		Supply Setpoint for HC Switch	
		Hysteresis	
	Condensation Delay		
Zone 2 Settings	Supply Temp. Settings	Heating	Calculated Supply Setpoint
			Heating Min. Supply Temp.
			Heating Max. Supply Temp.
			Deviation alarm limit
			Deviation alarm delay
		Cooling	Calculated Supply Setpoint
			Cooling Min. Supply Temp.
			Cooling Max. Supply Temp.
			Dew Point Margin
			Dew Point Offset
		DHW Supply Setpoint	
		Overheating alarm limit	
		Overheating alarm delay	
		Deviation alarm limit	
		Deviation alarm delay	

Heating Indoor Temp. Settings	Indoor Setpoint	
	Calculated Indoor Setpoint	
	ECO-Comf. Status	
	Indoor Setpoint Influence (Lower)	
	Indoor Setpoint Influence (Upper)	
DHW Circ Return Settings	DHW Circ Return Setpoint	
	BoostPower	
Comf. - ECO	ECO Setback	
	ECO-Comf Status	
	ECO-Comf Schedule	
Heating Curve	Setting	
	Offset	
	Heating Curve	
Cooling Curve	Setting	
	Offset	
	Cooling Curve	
Manual Operation	Manual Mode	
	Pump	
	Mixing valve	
Pump	Pump Exercise	
	Exercise Day of the Week	
	Exercise Hour	
	Exercise Min	
Mixing Valve	Heating	P-area
		I-time
		Actuator running time
	Cooling	P-area
		I-time
		Actuator running time
	P-area	
	I-time	
	Actuator running time	
Dehumidifier Control	Dew Point Margin	
	Dead Zone	

	Seasonal Shut Off	Heating	Pump Stop
			Valve Close
			Shut Off Outdoor Temp.
			T. Outdoor Setpoint
			T. Outdoor Delay
			Shut Off Indoor Temp.
			T. Indoor Delay
		Cooling	Pump Stop
			Valve Close
			T. Outdoor Setpoint
			T. Outdoor Delay
	HC Switchover	H/C Switchover	
		Outdoor Trigger Temp.	
		Outdoor Trigger Delay	
		Indoor Trigger Temp.	
		Indoor Trigger Delay.	
		Supply Setpoint for HC Switch	
		Hysteresis	
	Condensation Delay		
Zone 3 Settings	Supply Temp. Settings	Heating	Calculated Supply Setpoint
			Heating Min. Supply Temp.
			Heating Max. Supply Temp.
			Deviation alarm limit
			Deviation alarm delay
		Cooling	Calculated Supply Setpoint
			Cooling Min. Supply Temp.
			Cooling Max. Supply Temp.
			Dew Point Margin
			Dew Point Offset
		Calculated Supply Setpoint	
		Melting Supply Setpoint	
		Heating Curve Meltaway	
		IDLE Supply Setpoint	
		Min. Supply Temp. (IDLE Status)	
		Max. Supply Temp. (IDLE Status)	
	Heating Indoor Temp. Settings	Indoor Setpoint	
		Calculated Indoor Setpoint	
		ECO-Comf. Status	
		Indoor Setpoint Influence (Lower)	
		Indoor Setpoint Influence (Upper)	

Comf. - ECO	ECO Setback	
	ECO-Comf Status	
	ECO-Comf Schedule	
Heating Curve	Setting	
	Offset	
	Heating Curve	
Cooling Curve	Setting	
	Offset	
	Cooling Curve	
Meltaway Curve (IDLE Status)	Setting	
	Offset	
	Heating Curve	
Return Temperature	Max. Supply-Return Diff.	
Enter Stop State Conditions	Outdoor Temperature	
	Delay (days)	
Enter Idle State Conditions	Outdoor Temperature	
	Delay (hours)	
	Delay Surface Dry	
Enter Melting State Conditions	Ground Temperature Limit	
	Outdoor Temp. Offset	
	Outdoor Temperature Low Limit	
	Min. Time in Melting	
Manual Operation	Manual Mode	
	Pump	
	Mixing valve	
Pump	Pump Exercise	
	Exercise Day of the Week	
	Exercise Hour	
	Exercise Min	
Mixing Valve	Heating	P-area
		I-time
		Actuator running time
	Cooling	P-area
		I-time
		Actuator running time
	P-area	
	I-time	
	Actuator running time	

	Dehumidifier Control	Dew Point Margin	
		Dead Zone	
	Seasonal Shut Off	Heating	Pump Stop
			Valve Close
			Shut Off Outdoor Temp.
		T. Outdoor Setpoint	
		T. Outdoor Delay	
		Shut Off Indoor Temp.	
	Cooling	Pump Stop	
		Valve Close	
T. Outdoor Setpoint			
	T. Outdoor Delay		
HC Switchover	H/C Switchover		
	Outdoor Trigger Temp.		
	Outdoor Trigger Delay		
	Indoor Trigger Temp.		
	Indoor Trigger Delay.		
	Supply Setpoint for HC Switch		
	Hysteresis		
Automatic Freeze Protection	Primary return Temp. Low		
	Primary return Temp. High		
	Condensation Delay		
HC Switchover	H/C Switchover		
	Outdoor Trigger Temp.		
	Outdoor Trigger Delay		
	Indoor Trigger Temp.		
	Indoor Trigger Delay.		
	Supply Setpoint for HC Switch		
	Hysteresis		
Controller Settings	Time		
	Date		
	Language		

PRE HEATING OPERATING MODE

System Overview		
Pre Heating Info	System information	Time
		Date
	Zone 1 Information	Z1 - Supply Temperature
		State
		Time Left
	Zone 2 Information	Z2 - Supply Temperature
		State
		Time Left
	Zone 3 Information	Z3 - Supply Temperature
		State
		Time Left
	Controller Information	Language
		About...
Alarms	Active alarms	
	Alarm history	
	Acknowledge all alarms	
	Reset alarm history	

Pre Heating Settings	Installer Settings	Lock code
		Change lock code
		Display settings
		Restore factory settings
		Restore backup
		New backup
	Restart wizard	
	Zone 1 Settings	Z1 Max. Calc. Supply Setpoint
	Zone 2 Settings	Frost Protection Setpoint
		P-area
		I-time
		Actuator running time
	Zone 3 Settings	Z2 Max. Calc. Supply Setpoint
		Frost Protection Setpoint
		P-area
		I-time
	Zone 3 Settings	Actuator running time
		Z3 Max. Calc. Supply Setpoint
		Frost Protection Setpoint
		P-area
	Controller Settings	I-time
Actuator running time		
Time		
Date		
	Language	
	Operation mode	

8 Maintenance

The maintenance of Uponor Smatrix Move PRO includes the following:

- Manual preventive maintenance
- Automatic preventive maintenance
- Corrective maintenance
- Controller display

8.1 Manual preventive maintenance

Uponor Smatrix Move PRO requires no preventive maintenance except cleaning:

1. Use a dry soft cloth to clean the components.



WARNING!

Do not use any detergents to clean the Uponor Smatrix Move PRO components.

8.2 Automatic preventive maintenance

Uponor Smatrix Move PRO is equipped with an automatic exercise function. This function consists of a test run designed to prevent the pump from seizing up due to inactivity.

This exercise is run at fixed intervals, set in the menu system:

See section 7.10 Settings > Zone # Settings > Pump > Pump Exercise for more information.

- The pump exercise operates only in the zone if enabled in the Move PRO controller display. The pump is activated for 1 minute during the exercise.

8.3 Corrective maintenance

FALLBACK MODE

If a sensor is malfunctioning or not detected, the controller triggers an alarm and executes the fallback mode to maintain the temperature in the zone until the problem is resolved.

RESETTING THE CONTROLLER

If the controller does not work as expected, for example due to a hang-up, it can be reset (requires a service level code) to solve the problem:

See section 7.10 Settings > Installer Settings > Restore factory settings for more information.

8.4 Controller display

It is recommended to occasionally check the display on the controller for alarms. The display flashes continuously for general alarms, until acknowledged. Determine what is causing the alarm by reading the alarm description.

See section 7.8 Alarms for more information.

9 Troubleshooting

The table below shows problems and alarms that can occur with Uponor Smatrix Move PRO and describes solutions. A common cause of a problem though may be due to wrongly installed loops or mixed up thermostats.

Problem	Indication	Probable cause	Solutions
Fluctuating floor temperature	Floor temperature is changing abnormally between hot and cold	Supply water temperature is too high	Check boiler or mixing valve
	Room temperature does not match setpoint on the controller, and mixing valves open/close on a fixed interval	Heating fall back function is activated due to lost communication with an room sensor	Check the connection of the room sensor Reconnect if the connection is lost
	Room temperature does not match setpoint on the controller	The room sensor is placed in direct sunlight or close to other heat sources	Check placement of the room sensor according to installation instructions and change location if needed
The room sensor is placed in the wrong room.		Check the placement of the room sensor and change room if needed.	
The room is too cold (or too warm in cooling mode)	Check the indoor setpoint in the menu system	The indoor setpoint is too low	Change the temperature setpoint
	The temperature displayed in the controller menu system changes after the room sensor is moved	The room sensor may be influenced by an external heat source	Change location of the room sensor
	The indicator on the mixing valve actuator does not change/move	The mixing valve does not open	<ol style="list-style-type: none"> 1. Check that the mixing valve is correctly installed 2. Contact the installer 3. Replace the mixing valve
The room is too warm (or too cold in heating mode)	Corresponding loop is warm (or cold, in cooling mode) even after a long period without heat call (or cooling call)	A mixing valve does not close	<ol style="list-style-type: none"> 1. Check that the mixing valve is correctly installed 2. Contact the installer 3. Replace the mixing valve
The floor is cold	The room temperature OK but the floor is cold	No heat demand from the underfloor heating system	
		The room is heated by another heat source	
All rooms are cold (or too warm in cooling mode)	Check the indoor setpoint in the menu system	The indoor setpoint is too low (or too high, in cooling mode)	Change the temperature setpoint
	ECO mode for the zone programmed in the controller	ECO mode	Change ECO profile or assign another profile to the room/system Reduce the ECO setback value for the zone
Disturbing noise from the pump at the same time and day of the week		Pump exercise is active	Change time for pump exercise
No communication	Alarm shown in controller display	Communication error	Contact the installer
		Software versions incompatible	

9.1 Troubleshooting after installation

Problem	Indication	Probable cause	Solutions
The system does not start	The controller display is off	There is no AC power to the controller	<ol style="list-style-type: none"> 1. Check that the controller is connected to AC power 2. Check the wiring 3. Check that there is 230 V AC power in the wall socket
	There is 230 V AC power in the wall socket	Blown controller fuse or faulty power cable	<ol style="list-style-type: none"> 1. Replace the fuse and/or power cable and plug
The sensors are faulty	The controller display continue flashing and an alarm is displayed	The cable is not connected or a wire is damaged	Check the wiring

9.2 Contact the installer

For installer contact information, see the installation report in the end of this document. Prepare the following information before contacting an installer:

- Installation report
- Drawings of the underfloor heating system (if available)
- List of all alarms, including time and date

9.3 Installer instructions

To determine if a problem is caused by the supply system or the control system, loosen the actuators from the manifold for the room concerned, wait a few minutes and check if the flow pipe of the underfloor heating loop becomes warm.

If the pipe does not become warm, the problem is in the heating system. If the loop becomes warm, the cause could be the room control system.

A supply system defect can be indicated by no warm water in the manifold. Check the boiler and circulation pump.

10 Technical data

10.1 Technical data



General	
IP	IP20 (IP: degree of inaccessibility to active parts of the product and degree of water)
ErP (with room sensors)	III (VII)
Operating temperature	0 °C to +50 °C
Storage temperature	-20 °C to +70 °C
Mounting standard	EN 50022, DIN 46277-3
microSD	micro SDHC, UHS/Standard 4...32 GB, FAT 32 Class 4...10 +
Power Supply	
Operating voltage	230 V AC \pm 10%, 50/60 Hz (maximum 125 mA)
Battery input (UPS)	12 V DC / 125 mA
Transformer input	24 V AC / 0.7A (maximum 6 A)
Internal fuse	125 mA
Sensor inputs	
Supply temperature sensor	NTC 10
Return temperature sensor	-50 °C...+100 °C, \pm 0.1 °C
Room temperature sensor	
Outdoor temperature sensor	
Ground temperature sensor (Snow and ice sensor)	
Moisture sensor (Snow and ice sensor)	$R_{OFF} = \infty \Omega$ $R_{ON} < 2M\Omega$
Relative humidity sensor	$U_{IN} = 0...10V$ 0...100% RH
Condensation sensor	$U_o < 5 V$ $I_o < 0.5 A$ $R_{OFF} > 11 k\Omega$ $R_{ON} < 1.6 k\Omega$
Outputs	
Mixing valves	$U_o = 0...10V$ $I_o < 10 mA$
Diverting valves	$U_o = 24 V AC$ $P_o < 10 VA$
Snow sensor	$U_o = 24 V AC$ $P_o < 10 VA$
Circulation pumps/Dehumidifiers (Zone 3: TRIAC)	$U_{IN} = 230 V AC$ $I_{IN} \leq 1 A$

Communication

BMS interface	MODBUS-RTU (RS-232)
	RJ45
Uponor Smatrix Base PRO bus	Galvanically isolated
	Terminals: -, A, B

10.2 Technical specifications



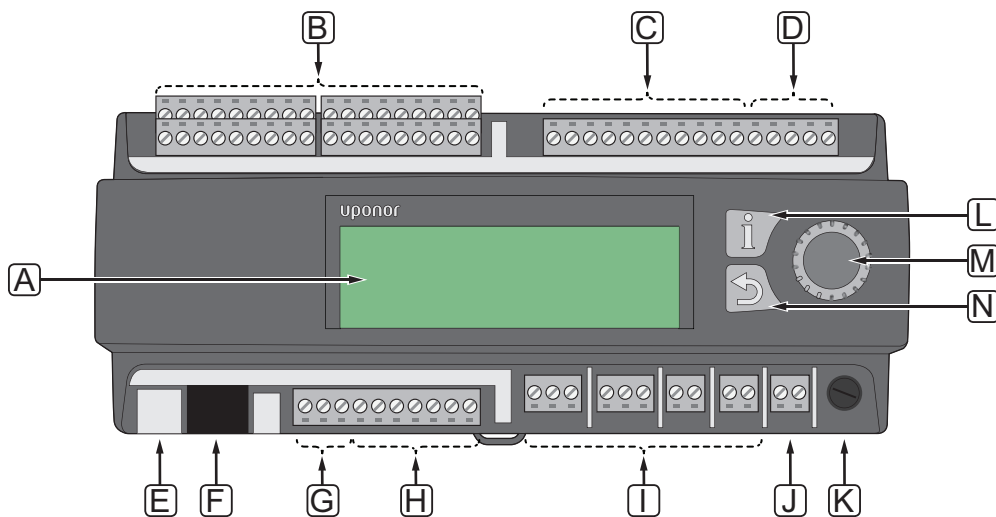





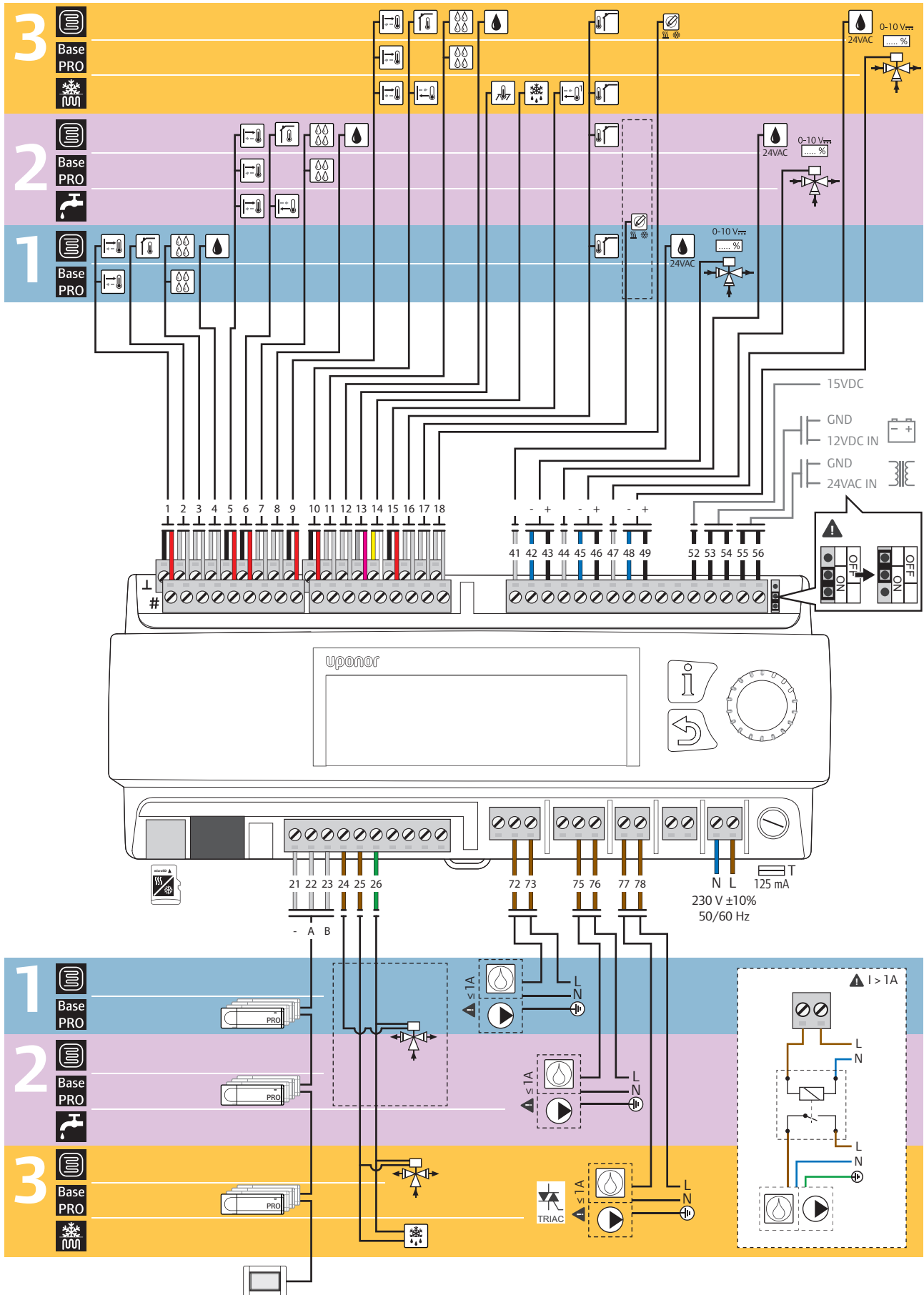







Cables	Standard cable length	Maximum cable length	Wire gauge
Cable from controller to valve actuator (shielded connected to ground)	0.75 m	20 m	0.2 mm ² to 1.5 mm ²
Cable to sensor input on controller (shielded connected to ground)	5 m	100 m	0.6 mm ²
Snow and ice sensor to controller	25 m	200 m	6 x 1.5 mm ²
Cable from output on controller to external devices	5 m	20 m	Up to 4.0 mm ² solid, or 2.5 mm ² flexible with ferrules
Communication cable	-	5 m	0.5 mm ² to 2.5 mm ²
Power cable	2 m	20 m	Up to 4.0 mm ² solid, or 2.5 mm ² flexible with ferrules









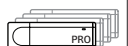



10.3 Controller layout

Item	Description
A	Display
B	Sensor input connection terminals
C	Mixing valve output connection terminals
D	Battery and transformer input connection terminals
E	microSD
F	BMS, MODBUS-RTU (RS-232), connection
G	Uponor Smatrix Base PRO bus connection terminals
H	Diverting valves/Snow and ice sensor output connection terminals
I	Circulation pump/Dehumidifier output connection terminals
J	Power connection connection terminal
K	Fuse (125 mA)
L	Information button
M	Navigation wheel/ OK button
N	Back button

10.4 Wiring diagram, Uponor Smatrix Move PRO controller



Setup	Sensors		Connection terminals		
			Zone 1	Zone 2	Zone 3
Stand Alone Control		Supply temperature sensor	1	5	9
		Indoor temperature sensor	2	6	10
		Condensation sensor	3	7	11
		Relative Humidity sensor	4, 41 (24 VAC)	8, 44 (24 VAC)	12, 47 (24 VAC)
		Outdoor temperature sensor	16		
		Mixing Valve	42 – 43	45 – 46	48 – 49
		Diverting Valve	24, 26		25 – 26
		Circulation pump ($I_{IN} \leq 1$ A)	72 – 73	75 – 76	77 – 78 (TRIAC)
		Dehumidifier ($I_{IN} \leq 1$ A)			
		Heating/Cooling switch/external signal	17		18
Smartix Base PRO		Supply temperature sensor	1	5	9
		Condensation sensor	3	7	11
		Mixing valve	42 – 43	45 – 46	48 – 49
		Diverting Valve	24, 26		25 – 26
		Circulation pump ($I_{IN} \leq 1$ A)	72 – 73	75 – 76	77 – 78 (TRIAC)
		Dehumidifier ($I_{IN} \leq 1$ A)			
		Smartix Base PRO controller (-, A, B)	21 – 23		

Setup	Sensors		Connection terminals		
			Zone 1	Zone 2	Zone 3
Meltaway		Supply temperature sensor			9
		Return temperature sensor			10
		Outdoor temperature sensor			16
		Ground temperature sensor			13
		Moisture sensor			14
		Primary return sensor			15
		Mixing valve			48 – 49
		Circulation pump ($I_{IN} \leq 1 \text{ A}$)			77 – 78 (TRIAC)
		Snow and ice sensor			25 – 26
Domestic Hot Water		Supply temperature sensor		5	
		Return temperature sensor		6	
		Mixing valve		45 – 46	
		Circulation pump ($I_{IN} \leq 1 \text{ A}$)		75 – 76	

10.5 Dimensions

CONTROLLER

X-159

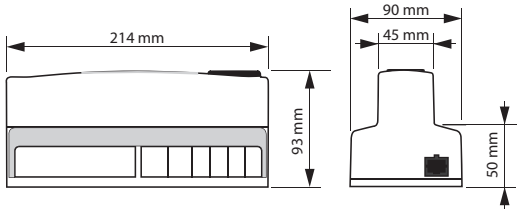

ROOM TEMPERATURE SENSOR

S-155

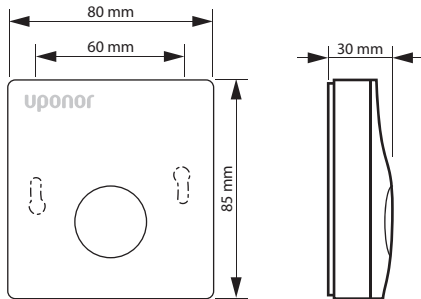

RELATIVE HUMIDITY SENSOR

S-157

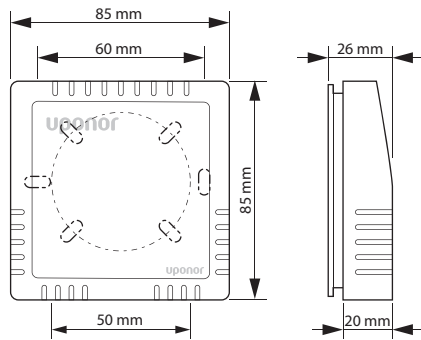





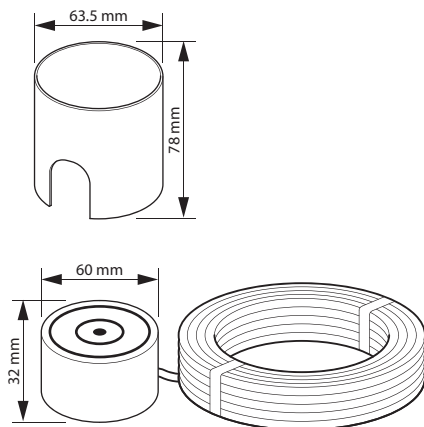



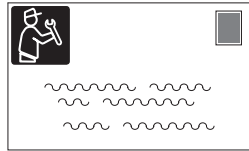
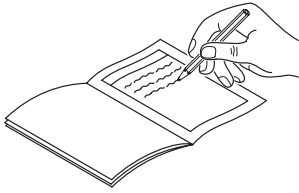

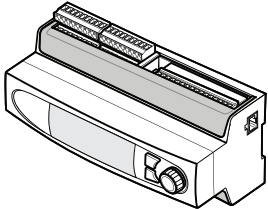
SNOW SENSOR











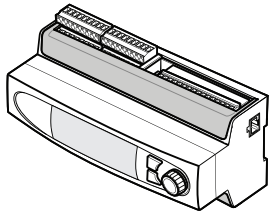





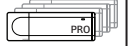

S-158







11 Installation report

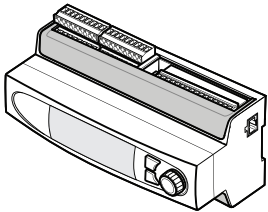

		Zone 1	Zone 2	Zone 3
				
Setup	Sensors			
Stand Alone Control	 Supply temperature sensor			
	 Indoor temperature sensor			
	 Condensation sensor			
	 Relative Humidity sensor			
	 Outdoor temperature sensor			
	 Mixing Valve	<input type="checkbox"/> Yes <input type="checkbox"/> No	<input type="checkbox"/> Yes <input type="checkbox"/> No	<input type="checkbox"/> Yes <input type="checkbox"/> No
	 Diverting Valve	<input type="checkbox"/> Yes <input type="checkbox"/> No	<input type="checkbox"/> Yes <input type="checkbox"/> No	<input type="checkbox"/> Yes <input type="checkbox"/> No
	 Circulation pump	<input type="checkbox"/> Yes <input type="checkbox"/> No	<input type="checkbox"/> Yes <input type="checkbox"/> No	<input type="checkbox"/> Yes <input type="checkbox"/> No
	 Dehumidifier	<input type="checkbox"/> Yes <input type="checkbox"/> No	<input type="checkbox"/> Yes <input type="checkbox"/> No	<input type="checkbox"/> Yes <input type="checkbox"/> No
	 Heating/Cooling switch/external signal	<input type="checkbox"/> Yes <input type="checkbox"/> No	<input type="checkbox"/> Yes <input type="checkbox"/> No	<input type="checkbox"/> Yes <input type="checkbox"/> No

			Zone 1	Zone 2	Zone 3
Setup	Sensors				
Smartix Base PRO	 Supply temperature sensor				
	 Condensation sensor				
	 0-10 V _{DC} Mixing valve		<input type="checkbox"/> Yes	<input type="checkbox"/> Yes	<input type="checkbox"/> Yes
			<input type="checkbox"/> No	<input type="checkbox"/> No	<input type="checkbox"/> No
	 Diverting Valve		<input type="checkbox"/> Yes	<input type="checkbox"/> Yes	<input type="checkbox"/> Yes
			<input type="checkbox"/> No	<input type="checkbox"/> No	<input type="checkbox"/> No
	 Circulation pump		<input type="checkbox"/> Yes	<input type="checkbox"/> Yes	<input type="checkbox"/> Yes
			<input type="checkbox"/> No	<input type="checkbox"/> No	<input type="checkbox"/> No
 Dehumidifier		<input type="checkbox"/> Yes	<input type="checkbox"/> Yes	<input type="checkbox"/> Yes	
		<input type="checkbox"/> No	<input type="checkbox"/> No	<input type="checkbox"/> No	
 Heating/Cooling switch/external signal		<input type="checkbox"/> Yes	<input type="checkbox"/> Yes	<input type="checkbox"/> Yes	
		<input type="checkbox"/> No	<input type="checkbox"/> No	<input type="checkbox"/> No	
	 Smartix Base PRO controller				
Meltaway	 Supply temperature sensor				
	 Return temperature sensor				
	 Outdoor temperature sensor				
	 Ground temperature sensor				
	 Moisture sensor				
	 Primary return sensor				
	 0-10 V _{DC} Mixing valve				<input type="checkbox"/> Yes
					<input type="checkbox"/> No
	 Circulation pump				<input type="checkbox"/> Yes
				<input type="checkbox"/> No	
 Snow and ice sensor					

		Zone 1	Zone 2	Zone 3
Setup	Sensors			
Domestic Hot Water	 Supply temperature sensor			
	 Return temperature sensor			
	 Mixing valve		<input type="checkbox"/> Yes	
			<input type="checkbox"/> No	
	 Circulation pump		<input type="checkbox"/> Yes	
			<input type="checkbox"/> No	



.....

.....

.....

.....

.....

.....

.....

.....

.....

.....

.....

.....

.....

.....

.....

.....

.....

.....

.....

.....

.....

.....

.....

.....

.....

.....

.....



Uponor Corporation
www.uponor.com

Uponor reserves the right to make changes, without prior notification, to the specification of incorporated components in line with its policy of continuous improvement and development.

Uponor