

Uponor

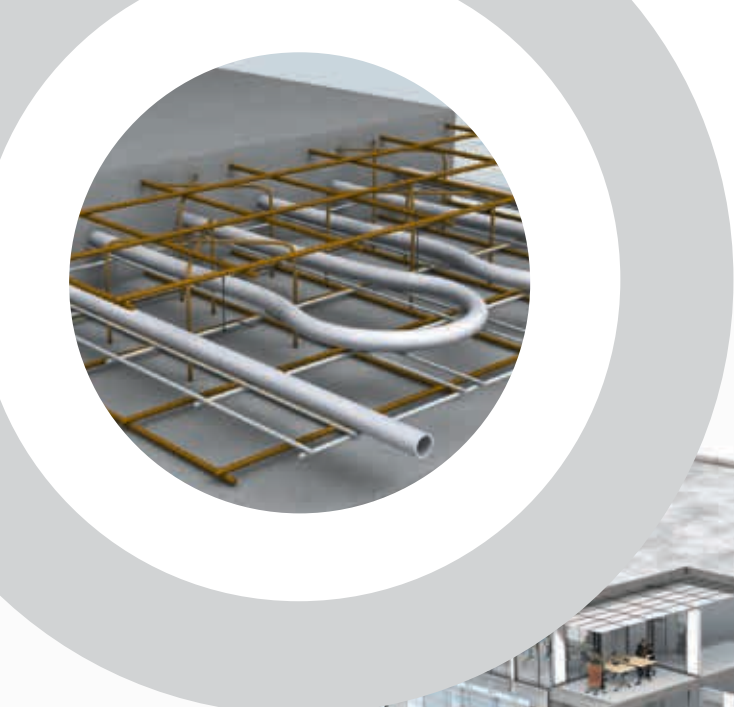

Uponor Contec compendium

THERMALLY ACTIVE
BUILDING SYSTEMS

Table of contents

1.	System description and application.....	5
1.1	Principle.....	6
1.2	Uponor Contec.....	6
2.	Why select TABS?.....	9
2.1	Thermal comfort.....	11
2.1.1	PMW and PPD	
2.1.2	Room operative temperatures	
2.1.3	Characteristic indoor climate	
2.1.4	Adaptation acc. to ISO 7730	
2.1.5	Further comfort parameters	
2.1.6	Hospital hygiene guidelines	
2.2	Work productivity.....	17
2.3	Life cycle cost of TABS compared to other HVAC schemes.....	18
2.4	Ideal for intelligent, sustainable architecture.....	22
2.5	Flexibility and space utilisation.....	23
2.6	Summary of TABS advantages.....	26
3.	TABS design basics.....	27
3.1	Cooling and heating sources.....	28
3.2	Options for heating & cooling systems with TABS.....	28
3.3	Notes on designing components for thermal utilisation of ground energy....	30
3.4	Thermal calculations.....	35
3.4.1	Calculation of output for the steady-state case	
3.4.2	Simplified model calculation based on finite difference method (FDM)	
3.5	Ceiling configurations.....	37
3.5.1	Output from a concrete slab without insulation	
3.5.2	Thermal output of a concrete slab with step-sound insulation layer	
3.5.3	Output from a concrete slab with raised access floor	
3.5.4	Reduction in output through acoustic measures, insulating layers or voids	
3.6	Dynamic considerations.....	41
3.6.1	Thermal building simulation for different building types	
3.6.2	Thermal building simulation for building with floor-to-ceiling glazing	
3.6.3	Thermal building simulation for a building with high thermal mass	
3.6.4	When should simulation be used?	
4.	Construction methods.....	47
4.1	In situ slab construction.....	48
4.2	Post-tension concrete slab.....	49
4.3	Filigree floor slab.....	49
4.4	Precast concrete floors.....	50
4.4.1	Common precast elements	
4.4.2	Hollow core	
4.5	Permanent formwork slabs.....	51
4.6	Special applications.....	52
4.6.1	BubbleDeck	
4.6.2	Cobiax®	
4.6.3	U-Boot®	
4.6.4	Ribbed and waffle slabs	
4.6.5	Polystyrene voiding blocks	
4.6.6	Renovation of historical buildings	
4.7	Wall installation.....	55

5.	Installation guidelines.....	57
5.1	Delivery of modules.....	57
5.2	Installation steps.....	59
5.3	General notes on installation according ISO 11855.....	62
5.4	Test protocols.....	63
6.	Uponor Contec systems.....	65
6.1	Uponor BIC (Built-In Clamp) System.....	66
6.2	Uponor Q system.....	67
6.3	Uponor Contec ON system.....	67
6.4	System components.....	68
6.5	System accessories.....	72
7.	Control and operation.....	75
7.1	Basics.....	76
7.1.1	Operation modes	
7.1.2	Operating temperature	
7.1.3	TABS zoning	
7.1.4	TABS hydraulic	
7.1.5	Sensors	
7.1.6	Condensation protection	
7.2	Combination with additional secondary systems.....	83
7.3	Different conventional TABS control strategies.....	83
7.4	Predictive TABS control.....	85
7.4.1	Concept	
7.4.2	Supply temperature control depending on predicted outside temperature	
7.4.3	Multiple Linear Regression	
8.	Acoustics.....	91
8.1	Basics.....	92
8.2	Relevant standards.....	94
8.3	Acousticsolutions.....	94
8.3.1	Acoustic plaster	
8.3.2	Wall, floor & furniture absorbers	
8.3.3	Wall partitions	
8.3.4	Vertical acoustic absorber	
8.3.5	Ceiling integrated absorber strips	
8.3.6	Activated acoustic elements	
8.4	Effect of acoustic measurements in heating/cooling capacity of TABS.....	98
9.	References.....	101
10.	Tender texts.....	117
10.1	BIC System.....	118
10.2	Q System.....	123

System description and application

1.1 Principle

The principle at work behind the “Thermally-Active Building System” (TABS acc. to ISO 11855-1) is based on the thermal storage capacity of parts of a building. This thermal capacity is well-known in historic buildings such as castles and churches: their very thick walls are able to absorb outside temperature variations.

The “Active” element of a combined cooling and heating system is achieved by embedding pipes in the structural concrete slabs or walls of the building. TABS operates at temperatures close to ambient which facilitates the integration of renewable energy and cooling sources that are free of cost. Furthermore, TABS has been a mature and well-proven technology for decades.

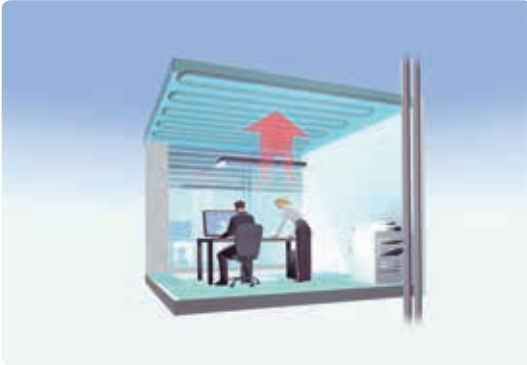

TABS - use of the thermal storage capacity of the building

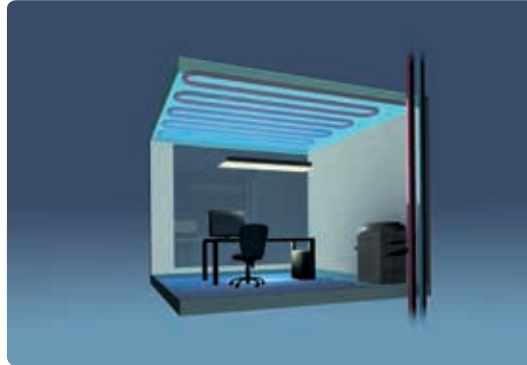

1.2 Uponor Contec

Concrete ceilings can be used for the cooling and/or heating of buildings. Uponor Contec turns ceilings into thermally-active elements with integrated modular pipe loops positioned in the slab structure.

This solution from Uponor utilises the thermal storage capacity of concrete ceilings in large commercial buildings such as office blocks or administrative premises, offering a future-proof and cost-efficient method of room climate control.

Uponor Contec is installed together with reinforcing elements in the concrete ceiling. Thermal activation of building structures is an ingenious technology that not only provides comfortable indoor climate but also helps protect the environment and save costs. The Uponor Contec System is a form of central heating and cooling which achieves indoor climate control primarily through thermal conduction and thermal radiation rather than convection.



BOB-the Balanced Office Building, Aachen, Germany, 2,000 m² Uponor Contec

Heating and cooling are achieved by circulating heated or chilled water (16-20 °C for cooling and 22-28 °C for heating). Compared to other forms of heating/cooling, this system creates no air turbulence due to the very low convection rate in heat transmission.

Additionally, naturally available energy sources are utilised in environmentally-friendly ways. The system operates within temperature ranges that are close to that of room temperature, which makes Uponor Contec ideal for use in conjunction with natural sources of cooling and low-temperature heat.

TABS is particularly recommended for buildings with small to medium cooling loads and in which rooms need to be kept cool during the summer months. In buildings with medium to large cooling loads, TABS can cover the basic load. This technology is thus becoming increasingly popular as an alternative to HVAC systems for heating/cooling. TABS reduces the air change rate to the basic level necessary for proper room hygiene (1x to 2x convection rate). It is thus possible to install a smaller ventilation system.

Advantages

- High thermal comfort for occupants resulting in enhanced work productivity
- Optimised utilisation of renewable energy sources
- System components are largely maintenance free
- Complete freedom of room utilisation (no restrictions in room design)

Why select TABS?

This chapter highlights system features which result in clear benefits for both occupants and building owners. These benefits are due to the high quality of indoor environment provided by the system, and the low life-cycle costs associated with a thermally-active system and its integration into a building.

Short and long-term benefits of the Uponor Contec system:



High level of thermal comfort for occupants:

TABS (reference ISO11855-1) is silent in operation. There is no noise from fans, it creates neither dust nor indoor draughts, and heat exchange occurs by means of pleasant uniform radiation in all parts of a room, thus eliminating temperature asymmetry. TABS performs via large surface emitters with low gradient. The system provides a better, healthier indoor environment for a perfect place to live or work.



Low investment and energy-efficient operation:

Life-cycle cost assessments show: the longer the lifetime of system components, the lower the overall whole-life costs. For TABS and borehole heat exchangers with 50+ years of lifetime (equal to the lifetime of a building), this creates a substantial advantage compared to short-life components such as fan coils. Furthermore, the operation of long-life components is, to a great extent, maintenance free, and primary energy use is significantly lower than for all-air systems.



Optimised utilisation of renewable energy sources:

Low temperature heating and high-temperature cooling with TABS is the key to integrating renewable energy sources into high-performance buildings. The use of large surface emitters allows heating and cooling at temperatures very close to that of the ambient environment. This means that renewable energy available from the ground, ground or sea water, sun and air can be easily integrated and utilised.

The TABS large surface emitters are highly suitable for the use of free or low cost energy in accordance with low exergy design principles. This is due to the low lift between ambient temperature, flow temperature and room temperature which enables extensive free cooling (approx. 75 % in Europe) during the summer period. The chiller/GSHP operates with a very high COP.



Complete freedom of room utilisation – no restrictions in room design:

TABS, as an active storage system for cooling and heating, is integrated into the structural concrete. Due to the reduced size of the technology used in water-based heat exchangers, TABS has no space requirements, unlike the air ducts required for an all-air system.

Thus, the partitioning of future offices and room utilisation can be determined independently of the embedded system. The possibility of using exposed concrete in their design is one reason why architects and designers favour the invisible cooling option provided by TABS.



Reliability & trust in a proven system:

The Uponor system was the first of its kind in thermally-active building systems and has been proven in more than 1,000 buildings since 1997. It is made of durable and long lasting components, and has successfully been installed worldwide in the highly divergent climatic regions of four continents. This includes climates as diverse as Moscow in Russia, Central Europe, inland and coastal Europe, Southern Europe, the Middle East, Southeast Asia, South Africa and North America.

2.1 Thermal comfort

This chapter offers a detailed look at how TABS enhances thermal comfort. It outlines the basic principles and definitions of the term thermal comfort as well as the parameters required to create it, followed by specific system information.

According to ISO 7730 thermal comfort is “That condition of mind, which expresses satisfaction with the thermal environment”. Influencing parameters are indicated in two value tables describing a person’s activity:

- MET, corresponding to heat production
- CLO, corresponding to clothing level and thermal insulation

An additional three measured parameters describing the thermal environment at the workplace are taken into account:

- Operative temperature
- Air velocity
- Humidity

2.1.1 PMV and PPD

EN ISO 7730 is an international standard that can be used as a guideline to ensure an acceptable indoor thermal environment which is typically measured in terms of Predicted Percentage Dissatisfied (PPD) and Predicted Mean Vote (PMV). PMV/PPD basically predicts the percentage of a large group of people that are likely to feel “too warm” or “too cold” (EN ISO 7730 does not replace national standards and requirements, which must always be followed). For the purpose of design and assessment, indoor environmental input parameters and their interaction are defined in EN 15251.

The PMV is an index that predicts the mean value of votes for a given thermal environment from a large group of people. It encompasses a seven-point thermal sensation scale from +3 to 0 to -3 (hot, warm, slightly

warm, neutral, slightly cold, cool, cold), based on the heat balance of the human body. Thermal balance is obtained when the internal heat production in the body is equal to loss of heat to the environment.

The PPD predicts the number of thermally dissatisfied persons among a large group of people. The rest of the group will feel thermally neutral, slightly warm or slightly cool. The table below shows the desired operative temperature range during summer and winter, taking into consideration normal clothing and activity level, in order to achieve different comfort classes.

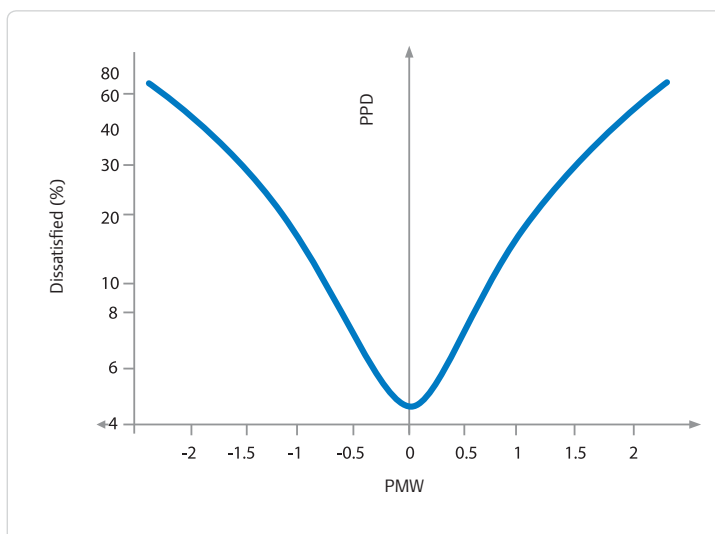

Desired operative temperature range

ISO 7730 recommends a target temperature of 22 °C in winter and 24.5 °C in summer. The higher the deviation from these target temperatures, the higher the percentage of dissatisfied people. The reason for the different target temperatures is that different clothing conditions apply in the different seasons, as can be seen in the diagram below.

CLO 1.0 includes a normal long shirt, thin sweater, normal trousers, socks and shoes. CLO 0.5 includes a short sleeve shirt, normal trousers, socks and shoes.

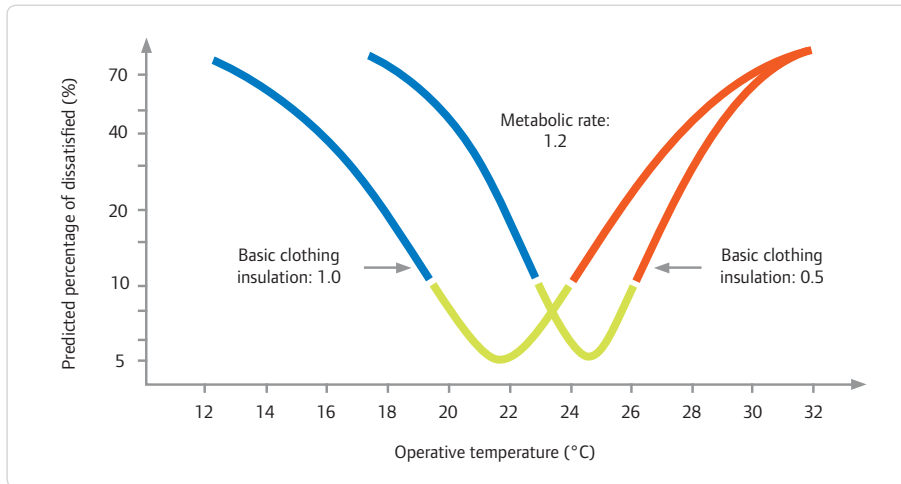

Operative temperature for summer and winter clothing

2.1.2 Room operative temperatures

Convective cooling and heating with air conditioning systems enables the room air temperature to be kept almost constant during the occupied period. However, this is not necessarily positive: occupants bothered by draught or noise from fans will feel dissatisfied. Dissatisfaction may be compounded by the fact that windows cannot be opened.

As mentioned above, the factors affecting general thermal comfort are CLO, MET, air temperature, mean radiant temperature, air velocity and humidity in the room. A surface system mainly influences the air temperature

and the mean radiant temperature, and only has limited effect on indoor air flow. Air temperature and radiant temperature are often quoted as a mean value. This mean value is called “operative temperature” or “dry resultant temperature” and is applicable to air velocity below 0.2 m/s.

The requirements for comfortable indoor climate therefore relate to an acceptable operative temperature range which combines both convective and radiative heat exchange.

2.1.3 Characteristic indoor climate

For structural and control reasons, TABS operates with small temperature differences. Its output is limited due to the relatively small difference between surface temperature and room temperature. In badly insulated buildings it is therefore not possible to fully compensate peak loads with immediate effect as energy is distributed over an extended period.

Room temperature will therefore rise slowly as a result of internal loads and ambient temperature or solar radiation (external load). However, the temperature tends to remain within a range that is perceived to be thermally comfortable. The system is particularly useful for preventing overheating of buildings during extended

hot spells. Many occupants perceive the radiant heat exchange which is accompanied by relatively cool room surfaces as very pleasant. Draughts are avoided due to low air velocities and low air turbulence rates.

Airborne systems that perform cooling primarily by convection are, however, able to keep room air temperature close to a setpoint. To achieve the setpoint in peak hours and the same operative temperature without cooled radiating surfaces, an increase in cooled air volume is required. Higher air volumes increase the percentage of dissatisfaction in relation to perceived comfort.

The operative temperature is used as a reference value for the room temperature in heating demand calculations (EN 12831). However, cooling load calculations (EN 15255, EN 15243) are still based on room air temperature. It is advisable to use the operative temperature for this purpose, as well. This is very important for surface systems, since it takes into account not only air temperature, but also radiant temperature and therefore surface temperature. Regardless of what system is used, general comfort is achieved with the same operative temperature, although the respective air and mean radiant temperatures may differ.

Most of the standards mentioned do not define a specific room temperature, but specify ranges for heating (20–24°C, winter) and cooling (23–26°C, summer) based on the dedicated category (ISO 7730 cat. A to C and EN15251 cat. I to IV). Normally, new buildings are designed to comply with category II or class B.

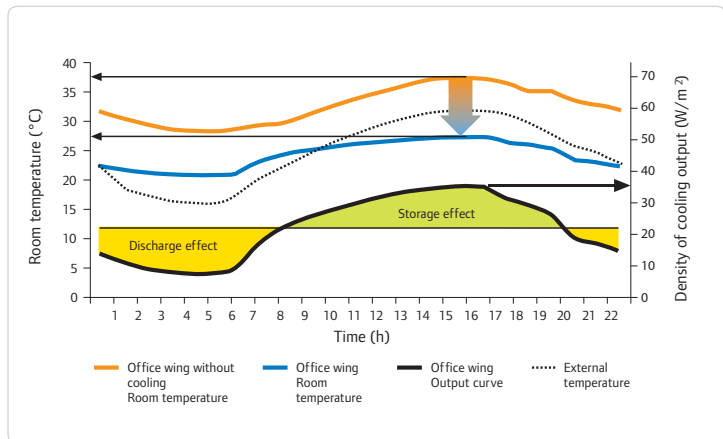

Diurnal temperature and cooling output curve. Comparison with and without concrete core activation

Class		Comfort requirements		Temperature range	
EN 15251	ISO 7730	PPD [%]	PMV [I]	Winter 1.0 clo 1.2 met [°C]	Summer 0.5 clo 1.2 met [°C]
I	A	< 6	- 0.2 < PMV < + 0.2	21–23	23.5–25.5
II	B	< 10	- 0.5 < PMV < + 0.5	20–24	23.0–26.0
III	C	< 15	- 0.7 < PMV < + 0.7	19–25	22.0–27.0

2.1.4 Adaptation acc. to ISO 7730

TABS utilises the operative room temperature range. Measurements confirm that the room temperature in the morning (in cooling mode) is at the lower limit, i.e. 21°C to 23°C, rising to the upper limit, i.e. 24°C to 26°C, during the day. Several studies with people showed that temperature changes of less than 4 K per hour are acceptable.

Thermal comfort can be assessed using the steady-state PMV-PPD method according to ISO 7730 when temperature ramps are below 2 K per hour. This means that

when the operative temperature during the summer is in the range of 23°C to 26°C (clothing ~ 0.5 CLO), it can be assumed that the subjective rating remains within an acceptable range (0.5 on the PMV scale) as long as the rate of temperature change is less than 2 K per hour.

Higher temperature ramps never occur in buildings with a thermally-active building system, normally they reach max. 0.5 K/h in reference to Kolarik 2008.

2.1.5. Further comfort parameters

Factors such as radiant temperature asymmetry (effect of different surface temperatures), draught (air temperature, air velocity, turbulence), temperature stratification and floor temperature also affect thermal comfort.

For ceiling systems, the requirement that radiant temperature asymmetry should be less than 5 K in heating

mode means that, for normal room heights, the ceiling surface temperature should be less than 28–30 °C.

In cooling mode, radiant temperature asymmetry is not particularly significant. The surface temperature is limited by the requirement that the temperature must not fall below the dew point.

For thermally-active floors, floor temperature should be in the range 19-29 °C. The temperature in the peripheral zone (up to 1 m from the external wall) may go up to 35 °C. For sedentary activities, floor temperature should not fall below 20 °C.

In heating mode, the risk of draught of cold air near the windows should be prevented. For typical office room heights, this is best achieved through installation of windows with a small U value (< 1.5 W/m²K). In many new buildings the windows' U value is typically around 1.0 W/m²K, and this fact avoids the negative effect of cold draught.

The comfort limit for air velocity is approx. 0.18 m/s (draught rate = 15 %, air temperature = 21 °C, turbulence rate 10-20 %). The requirements for a draught rate of 15 % are shown in the diagram below.

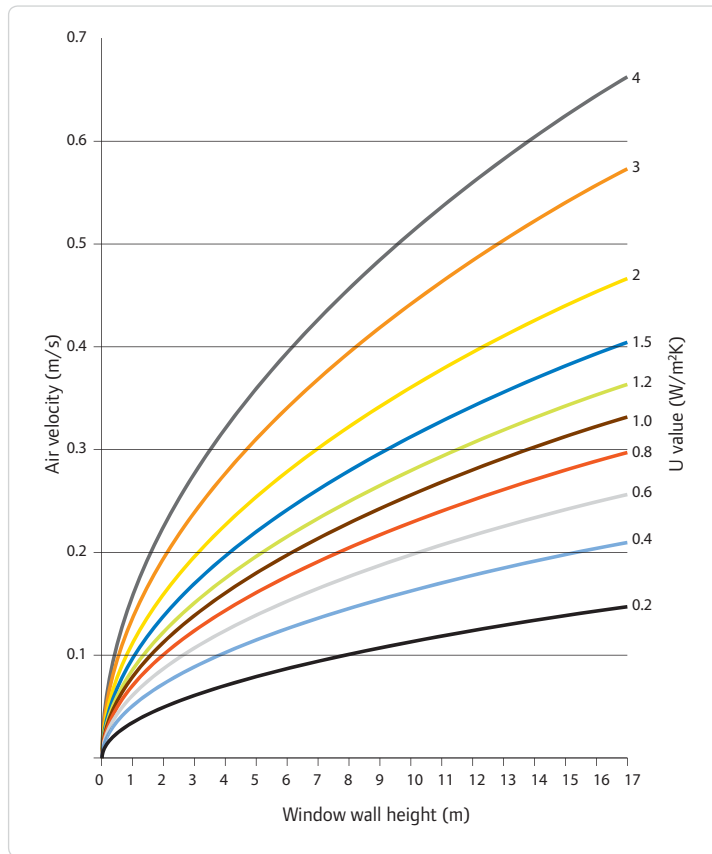

Relationship between window insulation and draught of cold air at -12 °C external temperature

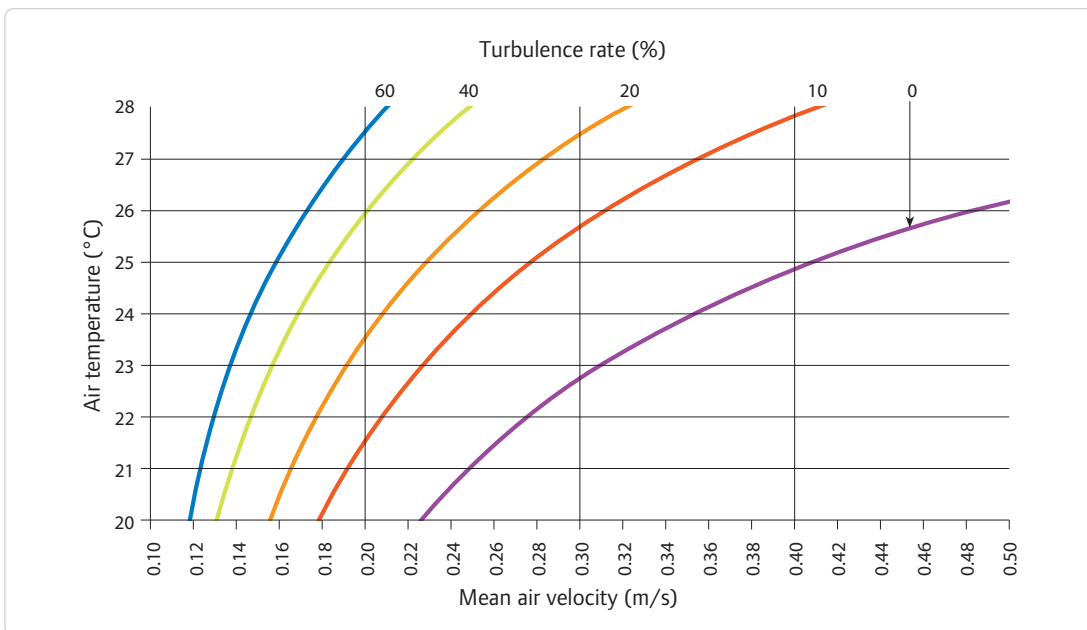

Acceptable mean air velocity as a function of air temperature and turbulence intensity (no more than 15 % of occupants dissatisfied due to draught)

In countries where local building code requirements for windows allow for higher U values than $1.5 \text{ W/m}^2\text{K}$ or where the external climate is more demanding, measures against draught of cold air include the installation of auxiliary floor heating in the peripheral zone up to 1 m from the external wall or, for very tall windows, installation of horizontal bars in order to interrupt any draught of cold air.

In the case of very tall windows of high U value, heating in the peripheral zone alone may not be sufficient. Here, the problem of draught can be solved by installing windows with better thermal insulation, or windows with horizontal bars that have a depth corresponding to the thickness of the boundary layer (see diagram below).

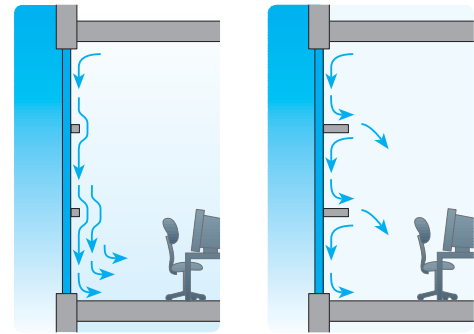

Horizontal bar has no effect

Cold air is interrupted

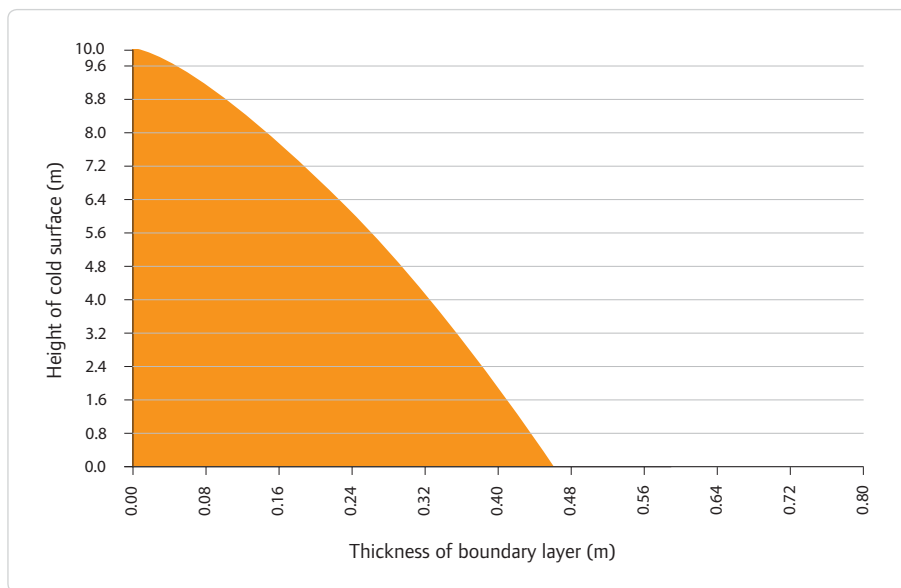

Thickness of boundary layer along the cold surface, $U = 1.5 \text{ W/m}^2\text{K}$, window height = 10 m

Surface heating and cooling systems can influence the room temperature, but cannot directly influence the humidity in a room. High humidity not only impairs comfort ('muggy' air) but can also limit the cooling output of surface systems if the temperature falls below dew point. Concrete core activation is therefore often installed in combination with mechanical ventilation systems, with the latter being designed for the minimum

fresh air volumes required for health reasons (1-2 air changes per hour) rather than the conventional 4-6 air changes per hour. In summer, the supply air is cooled to $19-20 \text{ }^\circ\text{C}$, in winter it is preheated to $20-22 \text{ }^\circ\text{C}$. Part of the load is therefore covered via the ventilation system using active coil or heat recovery only. The air may be dehumidified via an air-conditioning system.

2.1.6. Hospital hygiene guidelines

According to German, Austrian and Swiss guidelines, TABS is even recommended for use in hospitals. This shows that, for health reasons, TABS is also a perfect solution for other types of buildings with less sensitive occupants.

Especially remarkable:

The joint air-conditioning working group of DGKH (German Association for Hospital Hygiene) recommends the use of radiant heating and cooling in combination with air conditioning for hospitals.

In its "Hospital hygiene guidelines for the design and operation of air-conditioning systems in hospitals", the joint air-conditioning working group of DGKH, Deutsche Gesellschaft für Krankenhaushygiene e.V. (German Association for Hospital Hygiene), SGSH, Schweizerische Gesellschaft für Spitalhygiene (Swiss Association for Hospital Hygiene), and ÖGHMP, Österreichische Gesellschaft für Hygiene, Mikrobiologie und Präventivmedizin (Austrian Association for Hygiene, Microbiology and Preventive Medicine), expressly recommends the installation of TABS or surface heating/cooling systems.

Extracts from the guidelines are quoted below:

... "Hospital air conditioning concepts should be designed for the respective heating, cooling and ventilation demand, using separate systems as appropriate. In many cases, conventional systems involving large air-conditioned volume flows can be replaced with heated or cooled surfaces, often resulting in improved comfort. Water pipe registers installed in ceilings, floors and in some cases walls may be used for this purpose."...

... "In summer, operative room temperatures up to 25 °C are acceptable without problem, with the exception of operating theatres. With surface cooling, room air temperatures up to 26 °C are acceptable without violation of the comfort zone. If the fresh air volume flow required according to DIN 1946/2 is not sufficient for dealing with heat loads, cooling of structural components should be considered."...

Recommendations that are defined as a "basis for cost-effective air-conditioning systems" and based on the exacting hygiene and comfort requirements in hospitals can be transferred to other building types and used as a standard for office and administration buildings.

2.2. Work productivity

The use of TABS leads to an enhanced indoor climate. Creating a comfortable environment in commercial structures is a very important design consideration.

Employees that feel comfortable are more motivated and productive. Comfortable customers are more relaxed, contributing to the success of a business.

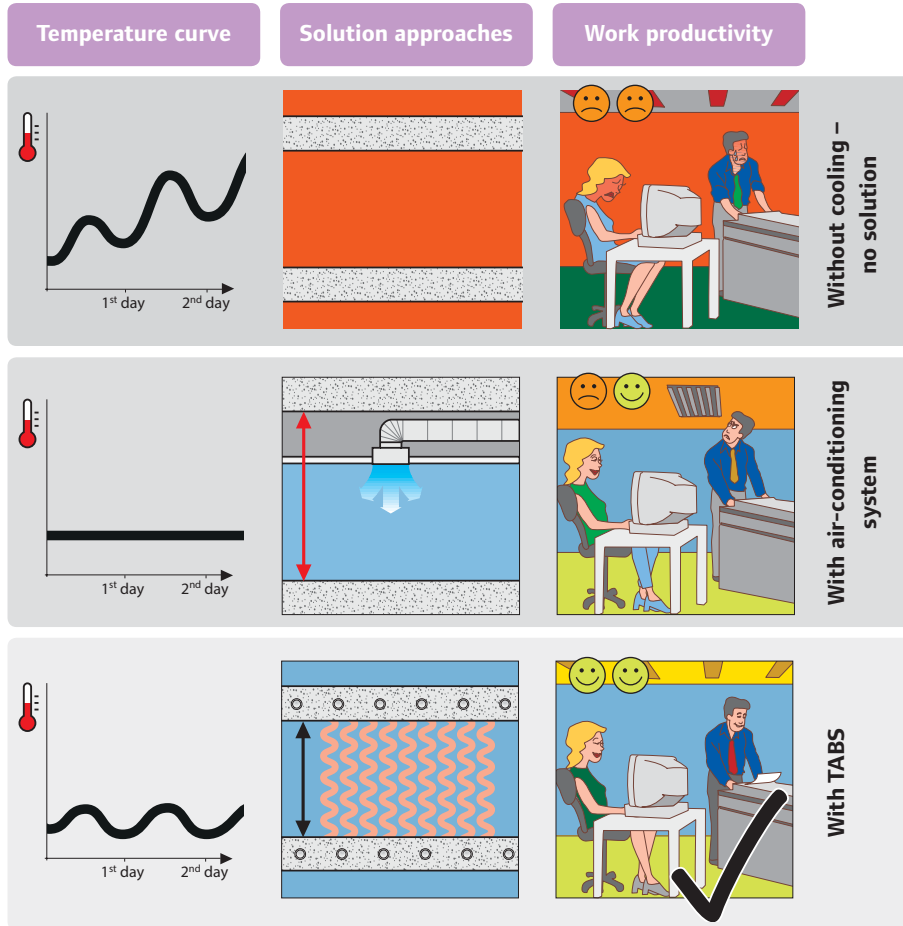

TABS leads to a comfortable indoor climate and hence higher staff motivation

The indoor environment in office buildings directly affects both sick leave and work performance. The direct and indirect cost of an adverse indoor office climate can easily be as high as the costs for heating, cooling and ventilation. Djukanovic et al. (2002) showed that the annual increase in productivity was worth at least 10 times as much as the increase in annual energy and maintenance costs when improving the perceived air quality in office buildings. Due to productivity gains, a pay-back time of no more than 4 months can be achieved.

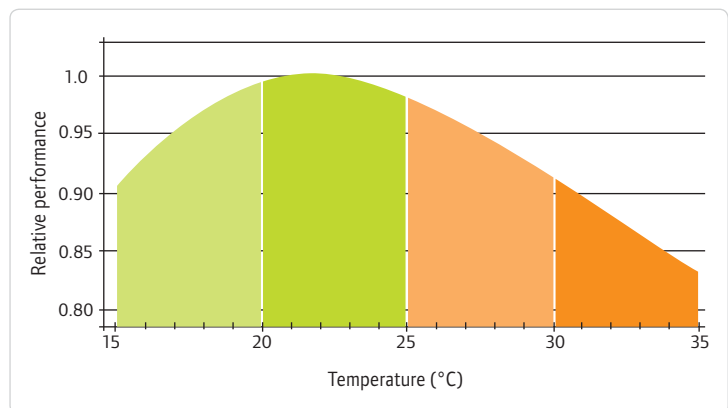

Relative performance of office work as a function of temperature (source: Rehva guide book no 6., Seppänen et. al 2006)

The adjacent graph demonstrates the relationship between energy, investment, running and staff costs for office buildings during their life cycle.

Low quality and a deterioration in thermal comfort due to inappropriate conditioning systems means that investment costs which were initially saved will quickly be outweighed by illness-related absence and low staff productivity.

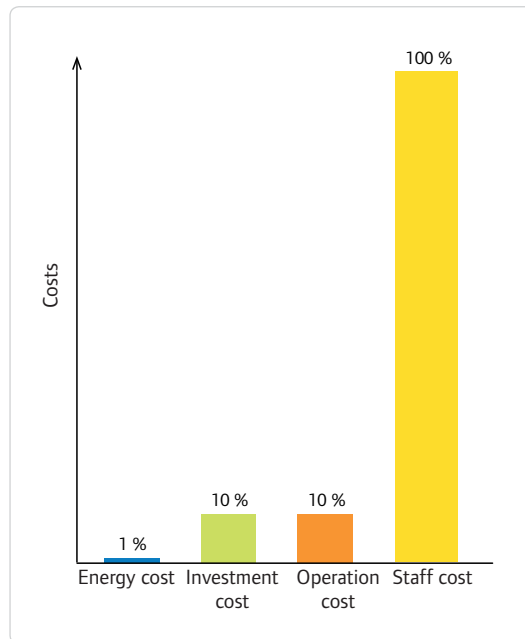

Source: Djukanovic et. al 2002

2.3. Life cycle cost of TABS compared to other HVAC schemes

The following case study example compares a Life Cycle Cost (LCC) analysis of a 1,000 m² office building using TABS with a traditional convective all-air conditioning, fan coils, displacement ventilation or variable air volume ventilation and chilled beam solution. This independent study is based on calculations conducted by international consultants.

The energy performance of the building was simulated using a building energy simulation tool (IDA ICE 4), and the LCC evaluation was carried out using the methodology of EU Regulation No 244/2012 for calculating cost-optimal levels of minimum energy performance requirements for buildings and building elements in terms of whole-life cost (global cost incl. initial investment, energy, running, disposal and subtracting the residual value) for a 15-year calculation.

The Building Energy Simulation (BES) modelling employed building envelope characteristics and internal/external climate load profiles typical for selected locations.

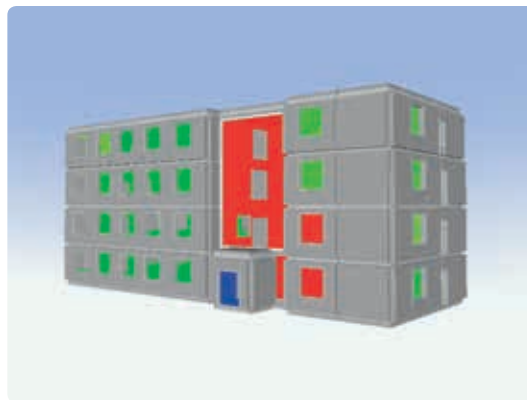





The local and central plant (HVAC system items) were sized based on cooling/heating loads and ventilation rates from BES modelling, using the same method as when completing a mechanical scheme design.

A full HVAC schemes design, including all necessary components, formed the basis of a quantity survey for each mechanical services method. Costs were obtained from a variety of sources, including manufacturers, construction economists, and the consultants' own expertise.

Compared HVAC schemes

The study was carried out for five countries (UK, Germany, France, Spain and Russia) and in each of these in two main locations. The HVAC schemes used in this

comparative study were selected based on what is commonly specified in the countries. The table below shows the UK example with five HVAC schemes:

	 Thermally active building system (TABS)	 TABS with ground source heat pump (GSHP)	 Fan coil units (FCU)	 Displacement ventilation (DV)	 Chilled beam (CB)
Heat source	Boiler	GSHP	Boiler	Boiler	Boiler
Heat sink	Chiller	GSHP + free cooling	Chiller	Chiller	Chiller
Complimentary room units	Convectors in selected rooms	Convectors in selected rooms	–	–	–
Ventilation	Mechanical minimum fresh air	Mechanical minimum fresh air	Mechanical minimum fresh air	Mechanical	Mechanical
Description	TABS for cooling and base load heating supplemented by mechanical minimum fresh air ventilation with a heating coil and heat recovery. Gas condensing boiler and central chiller as a heat source/sink. Complimentary convector radiators only in six rooms (corner room or top floor) which couldn't be fully covered with TABS capacity.	TABS with ground source heat pump (GSHP): The same as option 1, but boiler/chiller is replaced by a ground source heat pump (GSHP) with bore holes, which work to certain extent of summer period in a free cooling mode.	AC fan coil for cooling and heating supplemented by mechanical minimum fresh air ventilation with a heating coil and heat recovery. Gas condensing boiler and central chiller as a heat source/sink.	Displacement ventilation with central AHU for heating, cooling and ventilation using heat recovery. Central water chiller and a gas boiler. Reheater box is put locally in zones.	Active chilled beams provide cooling and heating, mechanical ventilation with a heating coil and heat recovery. Central water chiller and gas condensing boiler.

The mechanical minimum fresh air ventilation system was introduced to create the same indoor air quality (IAQ) condition for all compared cases. Toilets in all cases are equipped with an exhaust fan only (no air supply).

Standard default control algorithms are applied for the fan coil, beam and displacement ventilation cases. The global cost comparison is based on the above-mentioned complete HVAC schemes.

Cost of elements

Local and central plant (system items) are grouped based on the expected lifetime of each item (EN 15459). The items in each category all have the same predicted life expectancy:

No.	Lifetime categories	Equipment lifetime
1	Electricity, wiring, convector radiators	30 years
2	Building automation, controls	12 years
3	Distribution pipe work, manifolds	40 years
4	TABS, boreholes	50+ years
5	Central plant; AHU, ducts, chillers, heat pumps, heat exchangers, boilers, chilled beams, ductwork, attenuators, slot diffusers, pressurisation units	20 years
6	Pumps, valves	10 years
7	Other local HVAC components; FCU, VAV boxes, trimmer batteries, WC extract fans ductwork valves	12 years

Material and installation cost

Initial investment costs of mechanical systems (material and installation) is calculated as a sum of equipment lifetime categories. The diagram below shows an example for London, UK:

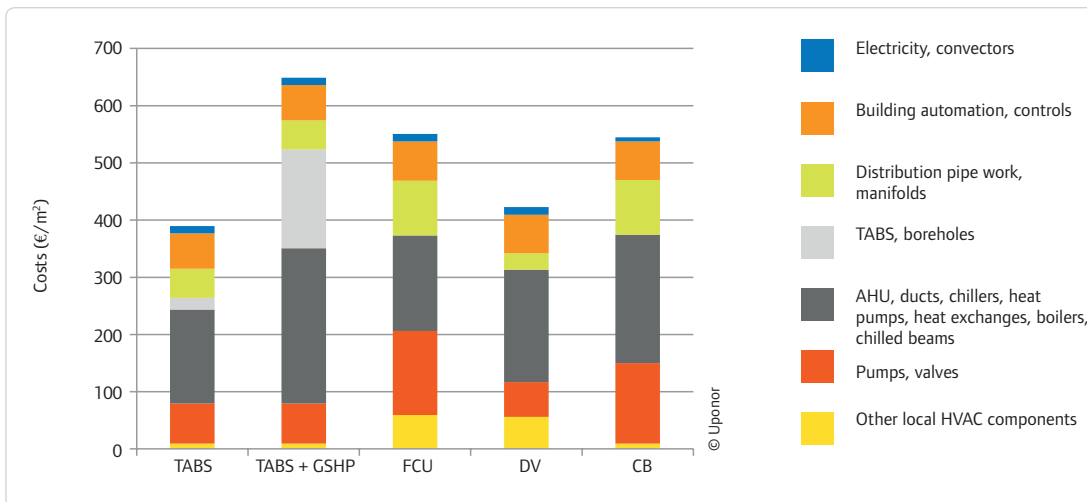

Due to differing indices of local costs, building insulation standards and climate conditions, the HVAC schemes are sized to different peak heating and cooling loads. This fact results in variations in material investment across countries. The first scheme, using TABS and a traditional heat source (boiler and chiller), requires the lowest investment cost. This is followed by air based HVAC schemes. The highest investment is related to the borehole field and a heat pump plant room as set out in the TABS + GSHP scheme.

Maintenance contract cost is assumed to be 5.5 % of the mechanical investment cost, excluding boreholes which are maintenance free throughout their lifetime. Annual costs cover all maintenance, inspection and cleaning, as well as minor replacements (e.g. filters).

Utilities and fuel prices for electricity and natural gas supply are available from relevant local bodies, whilst cost per kWh, cost of installing a new connection and an annual standing charge are taken into account.

Primary energy use

Annual rate of primary energy used per m² shows the total sum that is used by the building. Primary energy refers to the energy carriers at the beginning of the energy conversion chains (natural resources) prior to undergoing any human-made conversions or transformations. Local primary energy factors for electricity and for natural gas are applied. The graph below shows an

example for London, UK. It shows clearly that the use of boreholes for free cooling (bypassing GSHP) during 70-80 % of a cooling period enables significant energy savings. The GSHP or chiller, when applied, works with very high COP efficiency in conjunction with TABS, as flow temperature is very close to room temperature (max. difference of 5-8 K).

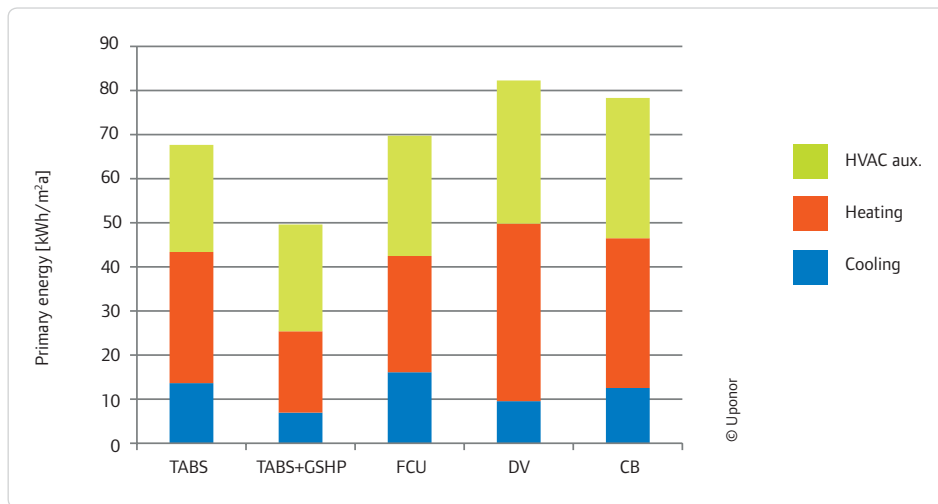

Whole-life cost per m² and year, calculation for 15-year period, medium price escalation of 3 % for gas and electricity. The example shown is for London, UK:

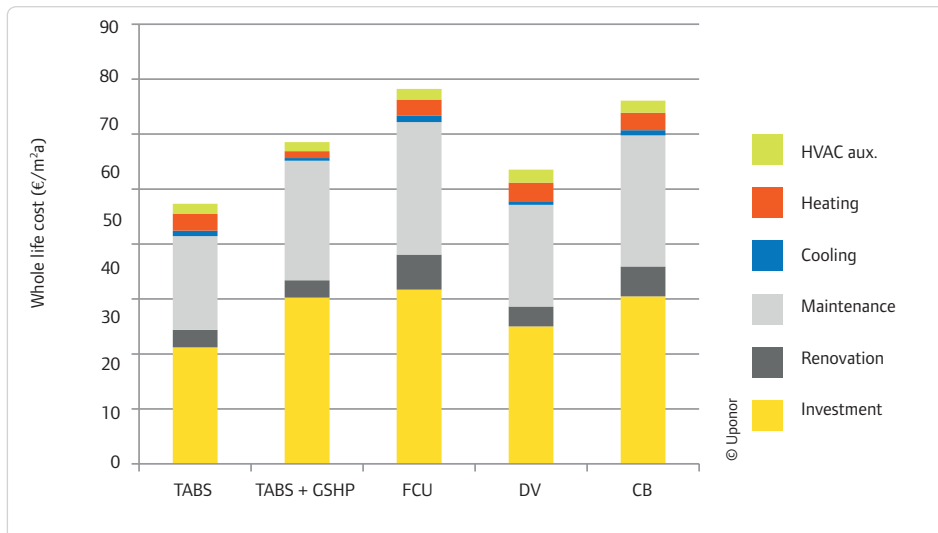

When TABS and borehole heat exchangers have 50 years of lifetime (the same lifetime as a building), this creates a substantial advantage over short-life components. The latter incur the highest whole-life costs as compared to long-life components.

The example below shows the different levels of investment for five countries in which the first scheme using TABS has been implemented. The differences are a result of differing local and labour costs:

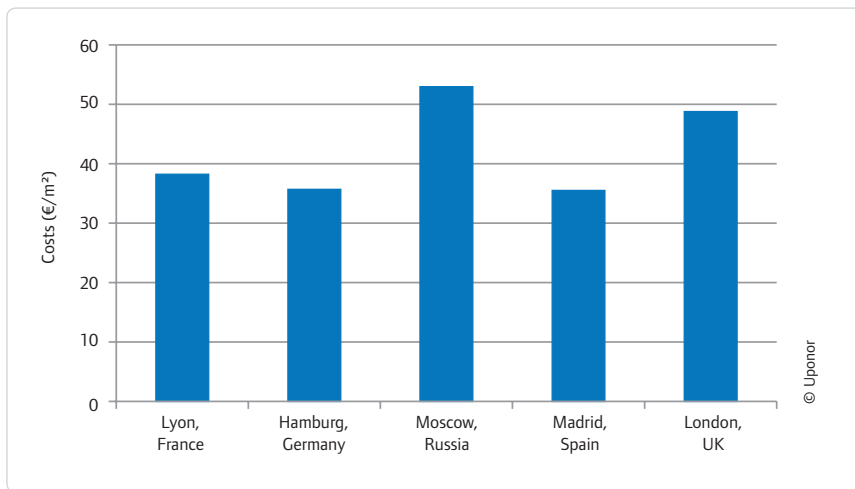

Conclusions

In all locations and countries, the result proves that selecting Uponor Contec for the HVAC scheme will significantly decrease its whole-life cost compared to alternative HVAC schemes. The evaluation has found that TABS provides cost savings in the range of 12 to 40 %. The key is that TABS consists of long-lasting components of the same lifetime as a building. This provides the advantage of high residual value for any LCC calculation, which in turn is highly beneficial to the overall valuation of real estate as it becomes very attractive for investors. Moreover, the appropriate thermal comfort with TABS can be reached with lower energy use and lower peak load (chiller downsizing by 60 % is possible for continuous operation) compared to airborne technologies. The FCU, DV and CB are also

able to reach the same temperature (comfort) levels as Uponor Contec, however, they would need to be upsized accordingly, thus increasing investment cost, maintenance cost and energy usage.

A life cycle cost comparison of the Uponor Contec system versus other HVAC systems is available for the UK, France, Germany, Russia and Spain. This report is based on an internal Uponor study "Full cost comparison of TABS vs. other HVAC" conducted in cooperation with independent consultants Equa Simulation Finland Oy and Mott MacDonald Limited, UK.

For further information about this study, please contact Uponor.

2.4. Ideal for intelligent, sustainable architecture

TABS, as an active storage system integrated into the structure of a building, has become an important component of modern architecture within a relatively short period of time, in effect since the late 90s. The architecture of the future aims to construct intelligent, sustainable buildings with ecological aspects in mind. Future statutory regulations that go beyond the EU energy-savings target of 2020, aim to further reduce the heating and cooling energy demand of buildings and will lead to new technical concepts for building equipment.

However, these concepts will not necessarily be based on expensive high-tech components, but may well be based on a "new simplicity" that refers back to earlier fundamental innovations as well as scientific and technical developments. Within this context, the development of ceilings used for radiant heating and cooling in the 1930s to today's active storage systems presents a logical progression. So far, more than 1,000 buildings have been equipped with Uponor Contec in Europe, Asia, Africa and America.

2.5. Flexibility and space utilisation

Flexible space utilisation – simple to fit out

The technical equipment of future office buildings should enable flexible space utilisation and variable partitioning. TABS systems meet these requirements. In contrast to other technologies, no costly structural modifications are needed to change air ducts or cooling equipment when new partitions are installed. The distribution pipework can be wholly integrated into the TABS

construction, whereas radiators act as an obstacle to room fitting, especially when close to windows. They decrease the effective area of space utilisation and additionally, due to their fixed position, radiators and air-conditioning units do not allow for free room partitioning and easy changes.

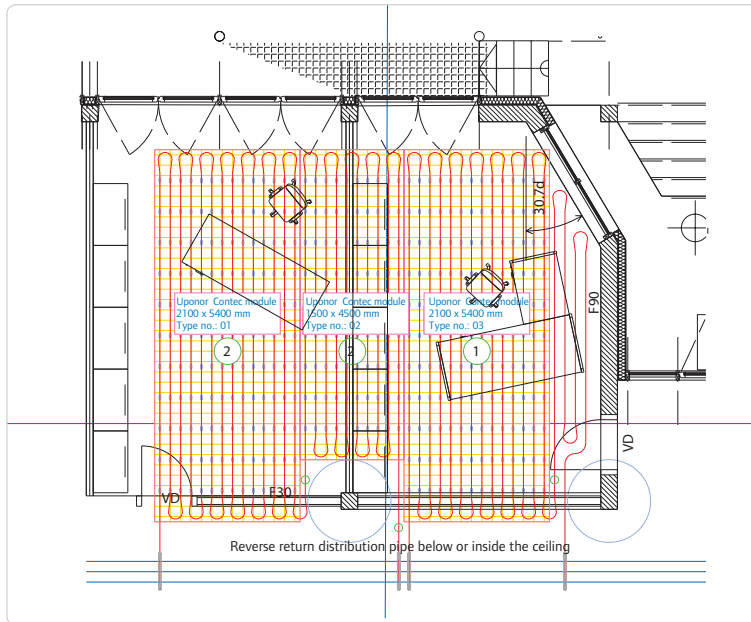

Typical floor plan with possibility of free partitioning without obstacles (radiators). Rearranging the partitions is possible.

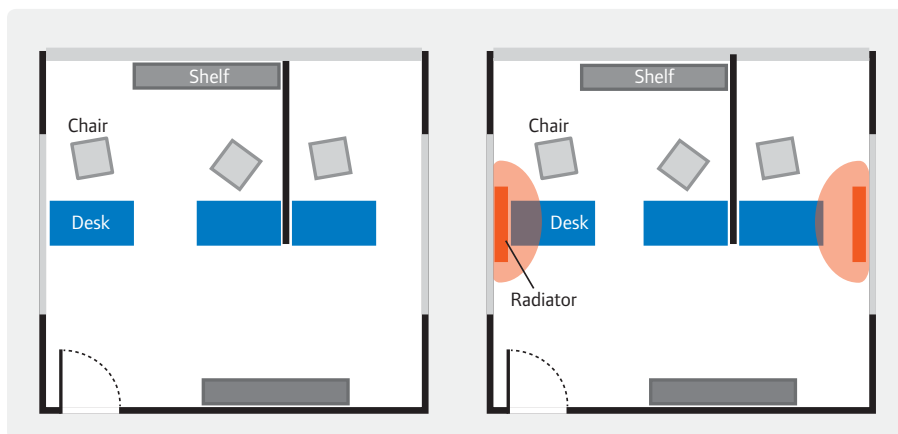

Comparison of room fit-out with and without radiators below the windows. The red markings show the positioning of radiators and the resultant wasted, inflexible space.

Building height savings

It should be noted that all-air systems have almost twice the space requirements for shafts and ducts as compared to alternative systems. This means that valuable office space is lost. TABS offers space saving through water-bearing systems integrated into structural components, with a massive **saving potential for building height** due to low ceilings and no suspended ceiling. On the other hand, a floor-to-ceiling height of 3.5 m is possible without an increase in building investment. This compares favourably to all-air conditioned buildings which traditionally have a ceiling height of 3.0 m.

TABS compensates the sensible thermal load so that any air-conditioning (mechanical fresh air) system that may be required can be designed purely for the purpose of maintaining indoor air quality. Decreased size results in lower space requirements for air system installation. Lower ceiling heights lead to a significant reduction in construction costs.

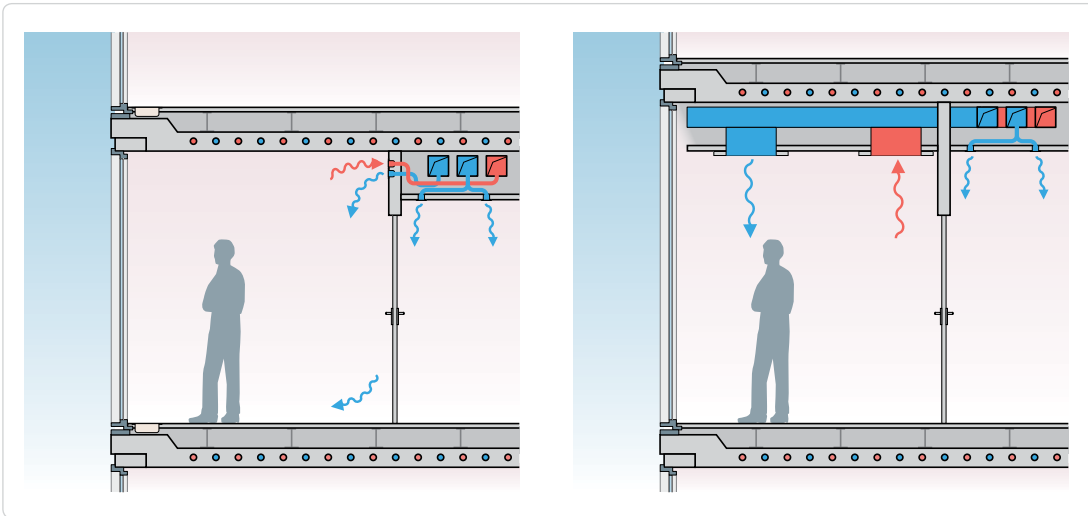

Comparison of the room height without suspended ceiling installation for traditional air ducts (TABS, left) and with suspended ceiling for air ducts (VAV, right). The room ceiling height is the same.

Selected examples of interiors:



Manchester Metropolitan University Business School, UK



Manchester Metropolitan University Business School, UK



ATMI Loyola Building, Indonesia



SOTE Semmelweis Medical University, Hungary



Bayer MaterialScience, China



Bayer MaterialScience, China



Uponor Academy, Spain

2.6 Summary of TABS advantages

- High thermal comfort for occupants resulting in enhanced work productivity
- Suitability for sensitive hospital rooms
- Optimised utilisation of renewable energy sources
- Low investment and operation costs (whole-life cost) compared to all other schemes
- System components are largely maintenance free
- Reliability – trust in a proven system
- Fully suitable for future, modern buildings
- Complete freedom of room utilisation (no restrictions in room design)
- Saving of building height as suspended ceiling for air ducts is omitted
- Avoiding physical injury to the elderly and to children. The pipework for TABS is often deeply embedded in the building structure compared to radiator convectors which act as obstacles.
- Avoiding painful bare hand/foot touch by the elderly or children of high temperature surfaces over the limit of 40–45 °C. With TABS, unlike radiators, this is not an issue.
- Energy carried by water is far more efficient than by air. Airborne systems perform cooling tasks mainly by convection. Without cooled radiating surfaces the same operative temperature requires more cooling energy due to the convection associated with high air volumes. This increases the risk for draught and discomfort. New systems should therefore be designed with separate components for heating and cooling or ventilation according to the energy-saving principle: water for heating and cooling, air only for ventilation (exclusively providing fresh air for health reason) and dehumidification (when appropriate).
- Due to thermal energy storage, peak load is flattened over longer periods of time and peak load on chillers can be lowered by over 50 % by continuous operation and by over 20 % by shorter night operation or pulse modulation.

Further advantages include:

- TABS enables thermally comfortable room temperatures during summer, in buildings with small to medium cooling loads typical for modern buildings. The system can also be used to cover the heating base load or full load in modern optimised buildings. The costs for auxiliary heating equipment are thus reduced. In certain cases (mainly future buildings) it is possible to omit all complimentary systems for heating and cooling.

TABS design basics

3.1 Cooling and heating sources

General boundary conditions and basic principles

For the selection of conventional cooling and heating devices, it is important to note that the temperature level of TABS will be close to room temperature. Taking into account the control characteristics and the envisaged output, supply temperatures will usually be in the following range:

- Cooling mode: $16\text{ °C} < t_{v,c} < 22\text{ °C}$
- Heating mode: $24\text{ °C} < t_{v,h} < 28\text{ °C}$

In terms of water temperatures, the TABS system can therefore be regarded as a high-temperature cooling system, or a very low-temperature heating system. In conjunction with appropriate refrigeration and heat generation concepts, high exergetic efficiency can therefore be achieved.

Taking into account this temperature level, low exergy factors equate to low operating costs both in cooling and heating mode.

For this reason, brine/water or water/water heat pumps are recommended for heating, chillers for high-temperature cooling, and reversible heat pumps for cooling and heating. In simultaneous heating and cooling mode, both the “cold” and “warm” sides of the heat pump can be utilised in conjunction with ‘buffer storage’, which is generally recommended in any case. Load management

requires particular attention. The system temperatures encountered provide an ideal opportunity to include renewables. Renewables are not only subsidised via the German Renewables Feed-In Act (“Gesetz für den Vorrang Erneuerbarer Energien”) (EEG of 1 April 2000) and the Building Energy Conservation Ordinance (“Energie-Einsparverordnung”) (EnEV 2002 of 1 February 2002), but already feature prominently in a wide range of winning projects in architectural competitions.

The following system configurations can be used to complement TABS:

- Geothermal/groundwater: free cooling, and combination with heat pumps
- Ambient air: combination with recirculation coolers
- Solar thermal: absorption refrigerating machines with additional solar collectors

In terms of conventional cooling sources, cold water flow temperatures of 16 °C are adequate and cost-effective for compensating sensitive heat. Chillers (supplying cold water flow temperatures of 6 °C) are only recommended if additional dehumidification is required. Depending on the size of the system, it may be expedient to use separate chillers for dehumidification (approx. 6 °C) and cooling ($> 16\text{ °C}$). An alternative is dehumidification based on sorption, which has been used successfully for some years now.

3.2 Options for heating & cooling systems with TABS

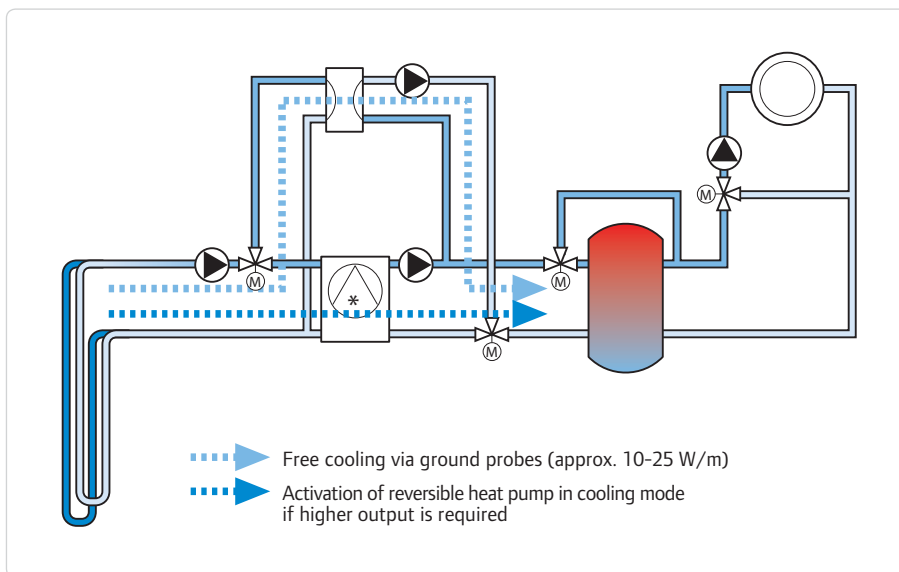

Free cooling and combination with a reversible heat pump

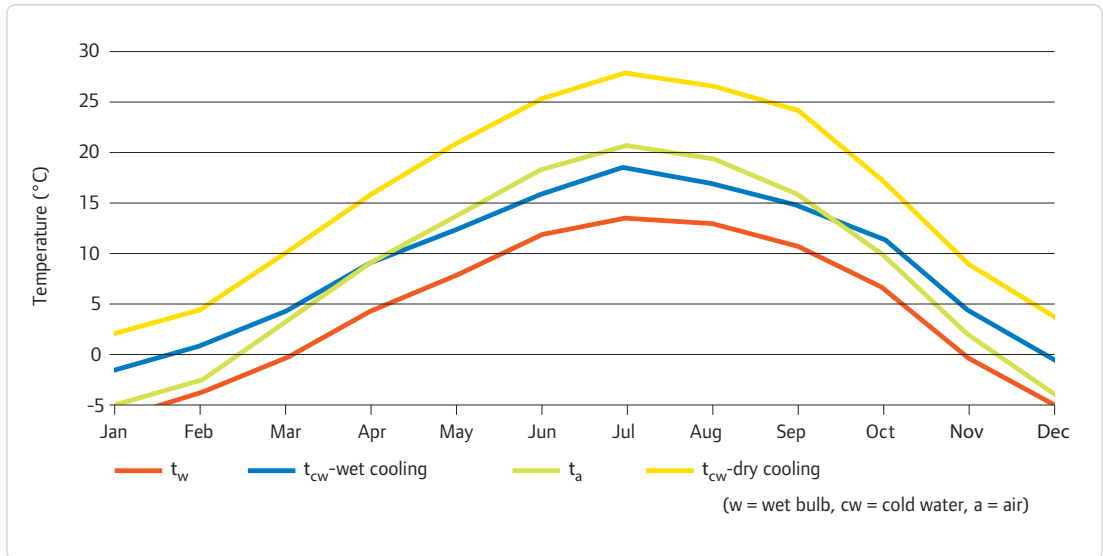

Cold water temperatures achievable with wet and dry cooling towers over the course of a year after Fackel-mayer

Seasonal cold water temperature levels available from the wet or dry cooler must be taken into account.



Recooling unit with pressure boosting www.dretec.de

Utilisation of recooling units for generating cold water

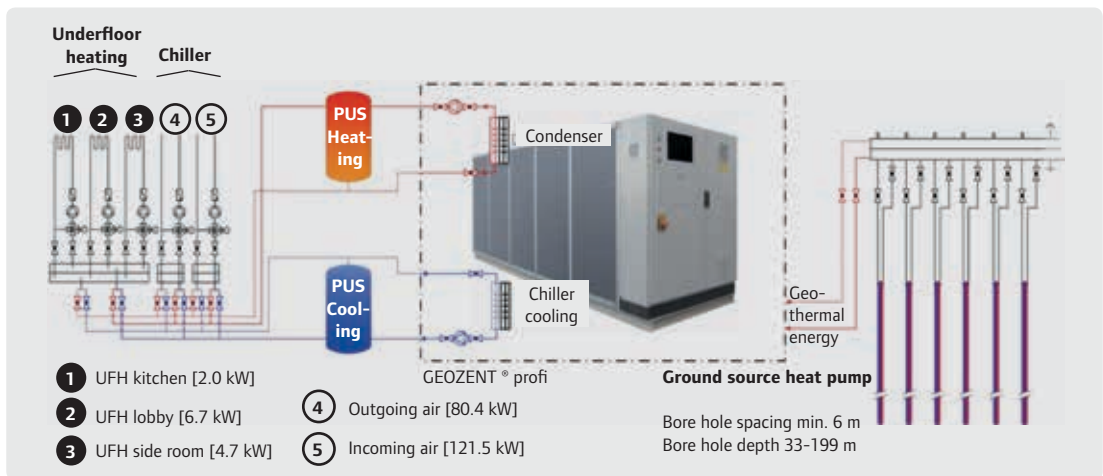

Function chart of geothermal energy supply with Geozent® profi

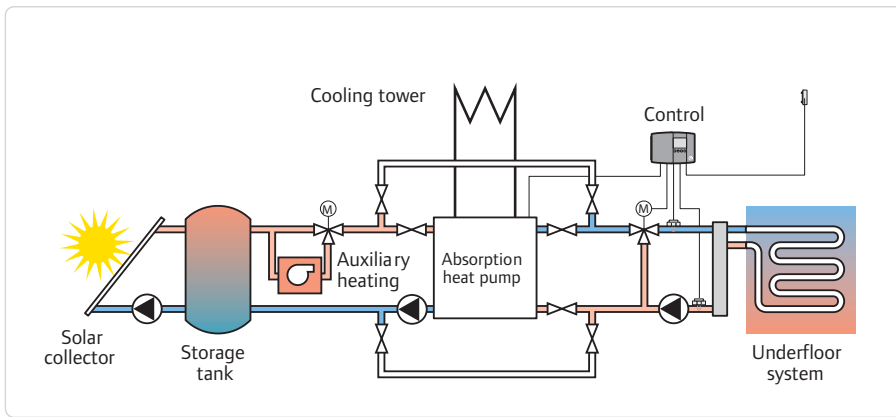

Cold water generation with solar thermal support

3.3 Notes on designing components for thermal utilisation of ground energy

System concept

Thermal utilisation of ground energy in conjunction with TABS provides an ideal solution. On the one hand, it can make a contribution to environmental protection; on the

other hand operating costs are reduced through the use of renewable energy. A distinction is made between horizontal and vertical collectors in the ground.

From a depth of approx. 10 metres, ground temperatures are relatively constant over the seasons, leading to more stable operating conditions for vertically oriented components. Energy piles are the preferred option in cases where pile foundations are required for the building. Otherwise ground probes are more cost-effective. Slotted walls are only applicable in special cases and can only offer limited depth. Their thermal performance is similar to that of the horizontally oriented components described below. Horizontal components are worth considering in cases where extensive ground excavation work is required, so that pipes or pipe registers can be laid in the soil or within a blinding layer relatively cost-effectively.

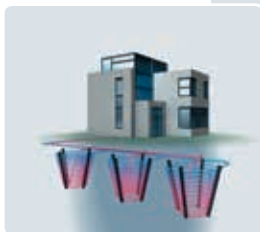

Unlike vertical components, the long-term performance of ground collectors is affected by temperature fluctuations. The performance of floor slab cooling systems is affected by possible thermal coupling with the basement, so that in both cases closer consideration is required. For these reasons, ground collectors are usually used for 'heat

pump heating mode', and floor slab cooling systems for free cooling or 'heat pump cooling mode' (refrigerating machine). The performance potential of a ground collector located adjacent to a building would be inadequate for space cooling during the summer, while using a floor slab cooling system as a thermal

absorber in winter involves frost risk for the foundation.

In addition to these heat exchangers, short or long-term ground stores (thermal energy storage according to VDI 4640) can be used, although these involve significantly more excavation and insulation work.

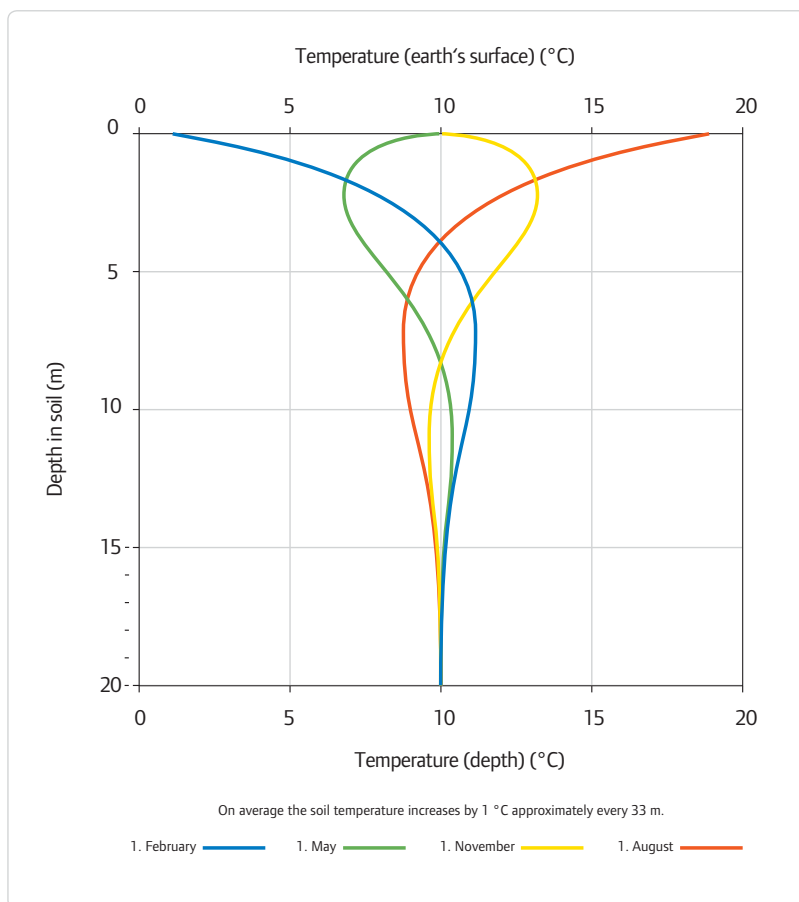

Geothermal components in practice



Installing the reinforcing cages



Concreting procedure of the in-situ piles

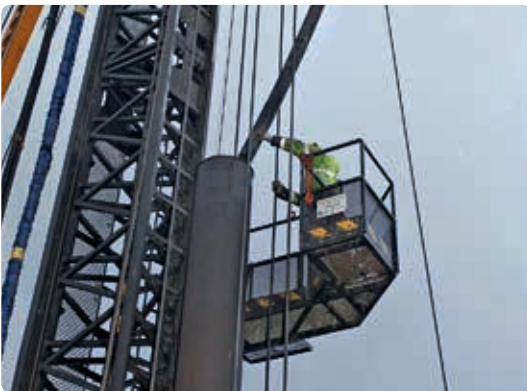

Filling pipe for concreting



Supervision of the pile assembly



Assembly of a bore pile



Prefabricated concrete bored pile

Basic design principles

Proper design of ground heat exchanger systems requires an understanding of the thermal interrelationships in the ground near the surface. Any design calculations should therefore be preceded by a geological survey in order to determine geological ground conditions at the site. From these survey results, the different thermal ground parameters required for an accurate calculation of the ground heat exchanger configuration can be derived.

For large systems that have to provide high security of supply, complex simulation calculations are recommended. These can provide insights into sustainable operation, possible effects on the geothermal balance of adjacent land, and any chemical/physical changes in the ground or groundwater.

For the design of ground collectors, floor slab cooling systems or foundation storage systems, ISO EN 13370 "Heat transfer via the ground – calculation methods"

and other guidelines can be used. This standard deals with the heat transfer of floor slabs, including thermally-active slabs, via the ground.

By modifying the system parameters (pipe registers, insulation, geometric dimensions of the building etc.) and system management variables, statements about the thermal performance of a floor slab cooling system during the summer can be derived.

VDI guideline 4640 "Thermal use of the underground" can be used for estimating system performance in heating mode. This document also contains information regarding approval procedures and environmental boundary conditions. However, a revision of this guideline for summer cooling is still outstanding.

The following tables provide an overview of the thermal extraction performance of ground types.

	Unit	Sand	Clay	Silt	Sandy clay
Water content	% Vol.	9.3	28.2	38.1	36.4
Heat conductivity	W/mK	1.22	1.54	1.49	1.76
Specific heat capacity	J/kg K	805	1.229	1.345	1.324
Density	kg/m ³	< 15	1.816	1.821	1.820

Physical properties of the characteristic soil types (source: VDI 4640)

Accurate modelling and more detailed calculations are also recommended in the following cases:

- Deviations of heat pump operating times from those mentioned above
- Higher heating energy demand for hot water generation
- Ground effect of heat input through space or commercial cooling or solar thermal recharging (annual balance method)
- Strong groundwater influence (drift velocity between 10 m/a and 150 m/a).

The above-mentioned guide values for thermal extraction performance are not necessarily directly transferable to summer operation. The following factors may lead to differences between extraction and input performance:

- Starting from an undisturbed ground temperature of more than 10 °C, in heating mode the ground

adjacent to the probes or pipes may cool down as far as freezing point. This temperature difference is greater than the thermally useful range in summer operation. For space cooling, the water temperature should not exceed approximately 17 °C, so that soil temperature has to be lower.

- In winter mode, an ice shield will form around the probe or pipe that influences heat conduction. In summer mode, heat conduction is characterised by moist or dry soil.
- Soil layers near the surface are subject to strong climatic influences, so that classic ground collectors that are not located below buildings should not actually be called geothermal, but solar thermal components. For floor slab cooling systems, these climatic influences only affect input performance in the edge zone, but on the whole, the efficiency of this type of component is determined by soil characteristics, including groundwater.

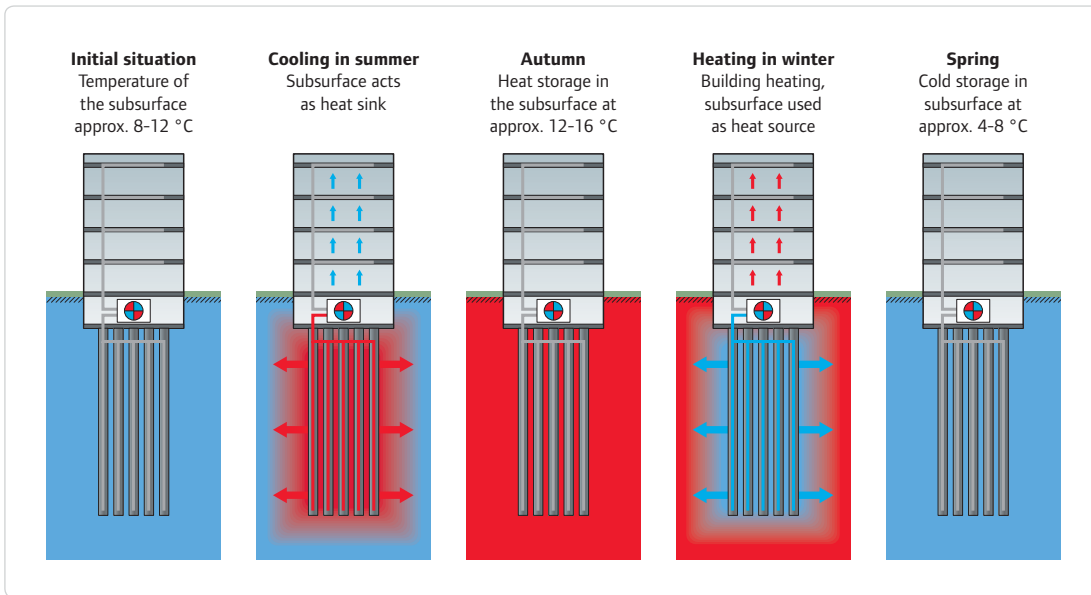

Energy piles: thermal utilisation of the subsurface

Differences in temperature lift between heating and cooling mode (ground probes)

For the purpose of estimating the long-term performance of ground probes and energy piles, it is therefore recommended to reduce the thermal extraction performance values quoted in VDI 4640 by 30 %.

For floor slab cooling systems, the following guide values can be used, based on theoretical considerations and practical experience including measurements:

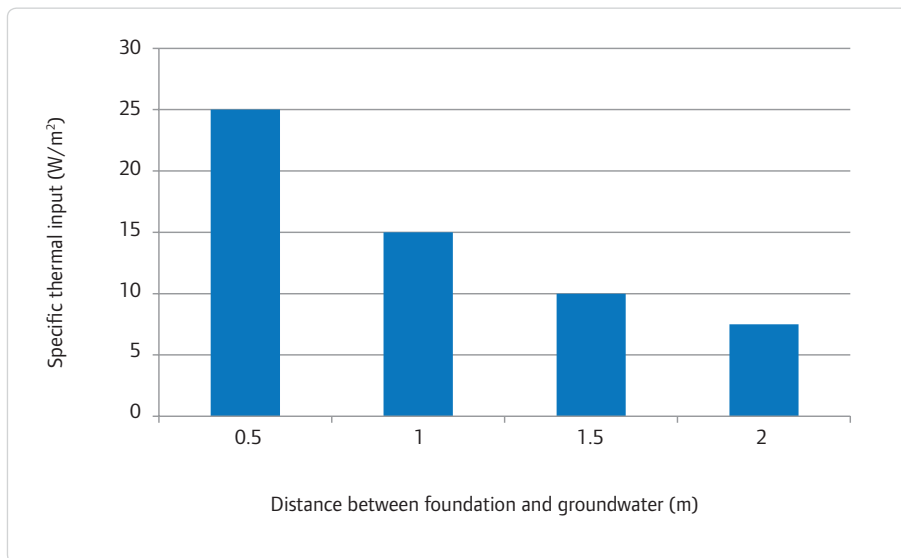

Specific thermal input (~ cooling load density) of a floor slab cooling system depending on the distance between groundwater and foundation (moist cohesive floor/saturated gravel or sand)

According to the current state of knowledge, the following design recommendations can be given for floor slab cooling systems:

- Specific input performance is strongly dependent on the groundwater level. Saturation, due to high ground water levels, of soil layers below the foundation increases heat conduction. This can lead to long-term cooling outputs that are similar to ceiling performance with concrete core activation, or floor performance with underfloor cooling.
- The pipe spacing should not exceed 15 cm.

3.4 Thermal calculations

3.4.1 Calculation of output for the steady-state case

Uponor will provide a project-specific calculation based on a given slab construction.

Unlike a dynamic approach that, for example, takes into account the thermal capacity of structural components, the steady-state approach represents a snapshot indicating performance due to heat transmission for the specified temperatures and a given ceiling construction.

The main parameters that determine the performance of a surface system are the heat transfer coefficient at the ceiling or floor, the acceptable minimum and maximum surface temperatures, and the available area.

Steady-state performance can be calculated based on standards for heating systems in buildings (ISO 11855). Design calculations for a given construction are based on the adjacent calculation parameters.

If TABS is used for cooling and basic heating, it is necessary to take into consideration that usually the amount of mass flow will not change between these two usages (same pump performance in winter and summer).

Because of this, water mass flow should be based on the cooling function. In order to achieve high performance with water temperatures that are as close to room temperature as possible, the difference between supply and return temperature should be small (2-5 K).

The required water mass flow is determined based on the maximum output (40-60 W/m²) and the spread. The maximum length of the cooling/heating circuit is then determined based on the maximum acceptable pressure loss.

New buildings such as passive houses have a very low heating or cooling demand. Their hydraulic design should take into consideration a turbulent mass flow with a Reynolds number above 2300. If necessary, a smaller pipe dimension, longer pipe loops or a lower mean water temperature must be designed.

- Regeneration phases during periods when the system is switched off or during periods with reduced or no cooling demand (cool summer days) improve performance potential.
- Performance may be higher if basement spaces are thermally coupled. However, if basement temperatures rise, long term performance will be reduced (similar to the effect of increasing soil temperature).

Calculation parameters

- Cooling
 - Supply temperature: 16°C
 - Return temperature: 20°C
 - Room temperature: 26°C
 - Relative humidity: 50 %
 - Heat transfer coefficient:
floor = 7 W/m²K; ceiling = 10.8 W/m²K
- Heating
 - Flow temperature: 28°C
 - Room temperature: 26°C
 - Heat transfer coefficient:
floor = 10.8 W/m²K; ceiling = 6 W/m²K

All slabs feature the following system:
System: Uponor Contec
Pipe: PE-Xa 20
Pipe spacing: 150 mm

3.4.2 Simplified model calculation based on finite difference method (FDM)

In general, calculations of output for the steady-state case are carried out to recognize the maximum power capacity that can be achieved under given boundary conditions. This provides important information to design the hydraulics of the system. To ensure accurate chiller sizing, dynamic simulations need to be carried out due to the high thermal inertia of TABS. Currently, Uponor uses methods internally that are described in the related standards, such as ISO 11855, to perform semi-dynamic calculations. The internal Uponor SST (Simple Simulation Tool) for TABS can be used to model the system.

As described in ISO 11885-4 there are different calculation methods.

1. Rough sizing method based on standard calculations (error: 20-30 %)
2. Simplified method using diagrams (error: 15-20 %)
3. Simplified model based on finite difference method (FDM) (error: 10-15 %)
4. Detailed energy simulation of building (error: 6-10 %)

It can be seen that the simplified model method based on FDM performs calculations with an accuracy that comes close to a detailed simulation.

The finite difference method is based on the calculation of heat balance for each thermal node defined within the slab and the room. Information about the structure (walls, windows), the TABS system and location must be defined for this calculation. Internal loads and maximum cooling power can be defined for every hour of the day for a defined room.

The SST for TABS is able to calculate a semi-dynamic temperature profile (operative temperature) for a single zone and allows conclusions about the sizing of TABS and the required chiller capacity taking into consideration different operation modes.

3.5 Ceiling configurations

Ceiling configurations without insulation or air gap are ideal for maximising the output of TABS. The following ceiling design variants are suitable for this purpose:

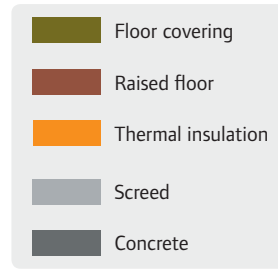

Concrete slab

Concrete slabs with only a thin floor covering or bonded screed deliver a maximum heating or cooling capacity upwards into the room.



Concrete slab with bonded screed

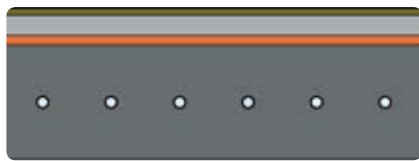

Concrete slab with impact sound insulation

Impact sound insulation reduces output via the floor. However, this design option is acceptable in applications where mainly the effect of cool ceilings is utilised.

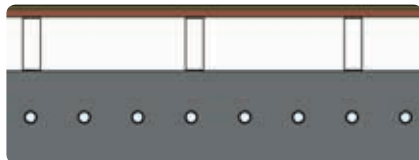

Concrete slab with raised floor

For a raised floor, the same considerations apply as for a floor with impact sound insulation. This type of ceiling construction is popular because power supply and EDP cables can be installed in the void.

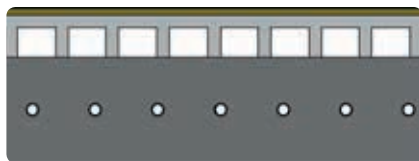

Concrete slab with hollow floor

Another variant that is frequently used in office buildings is the hollow floor construction. In terms of performance, it behaves similarly to the false floor. However, because screed (instead of floor panels) is used, inspection openings have to be used for the underfloor installations.

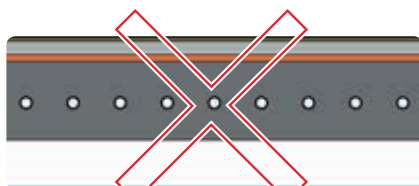

Concrete slab with suspended ceiling

Suspended ceiling are normally unsuitable in conjunction with concrete core activation. The false ceiling undermines the operating principle of concrete core activation. Specific applications include, for example, removal of heat emitted by lighting systems from ceiling voids.

3.5.1 Output from a concrete slab without insulation

A finite element calculation using a program for 2-dimensional heat transfer illustrates the temperature distribution in the structural component.

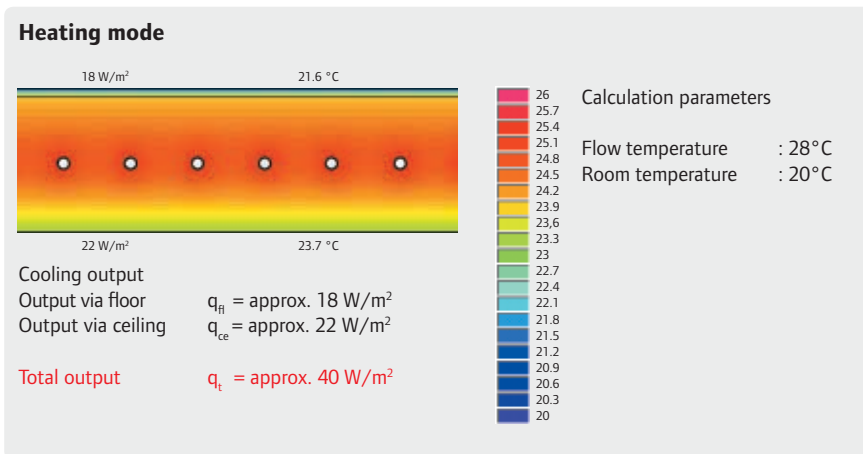
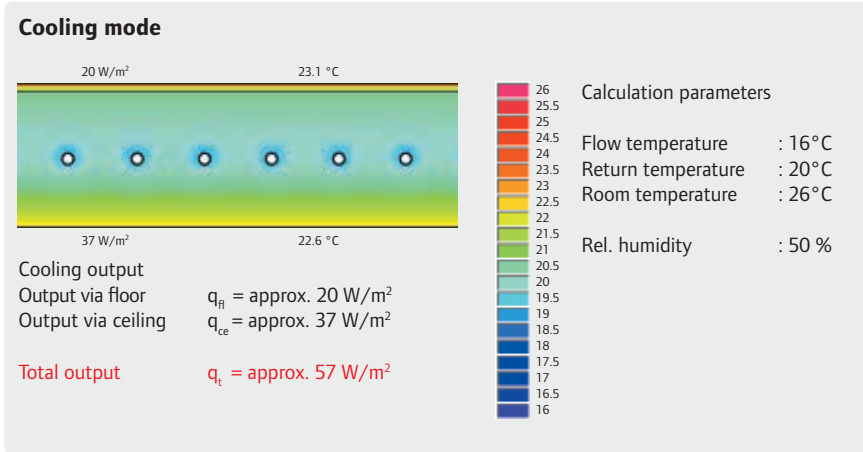
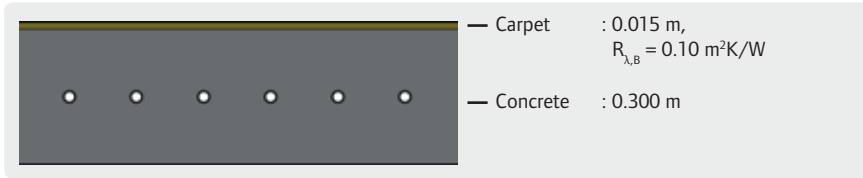

3.5.2 Thermal output of a concrete slab with step-sound insulation layer

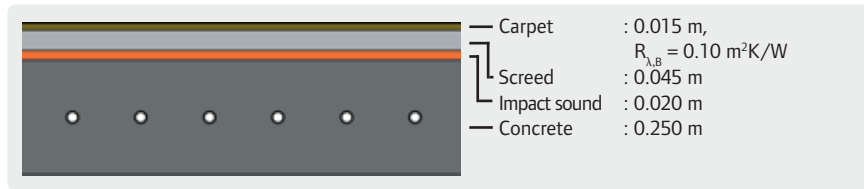

Cooling mode

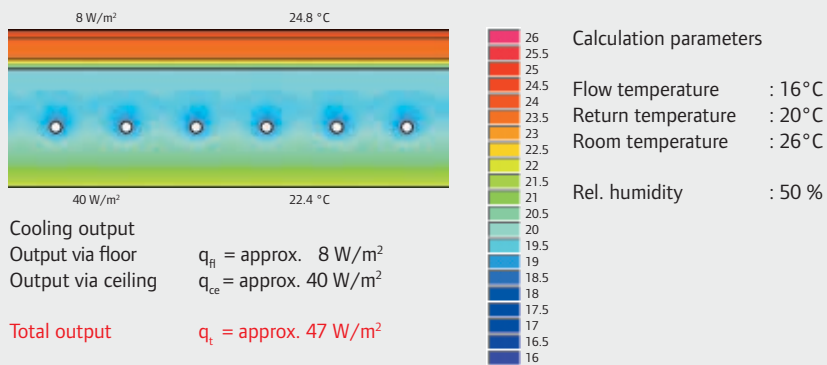

Heating mode

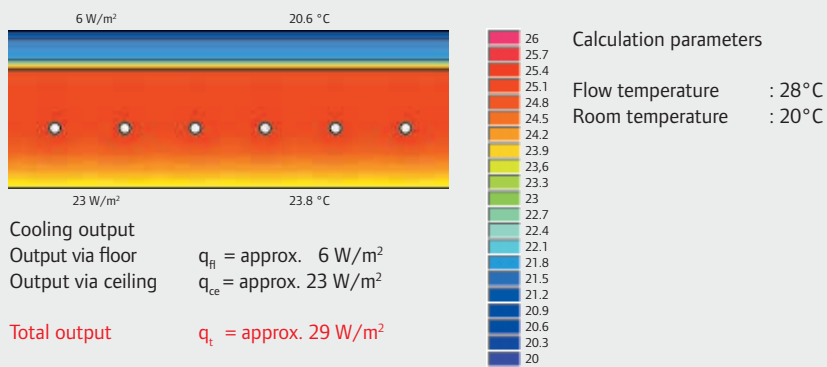

3.5.3 Output from a concrete slab with raised access floor

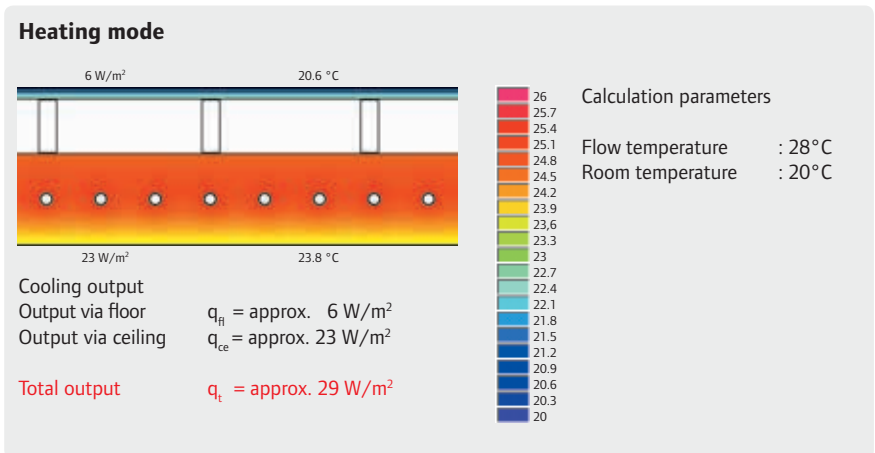
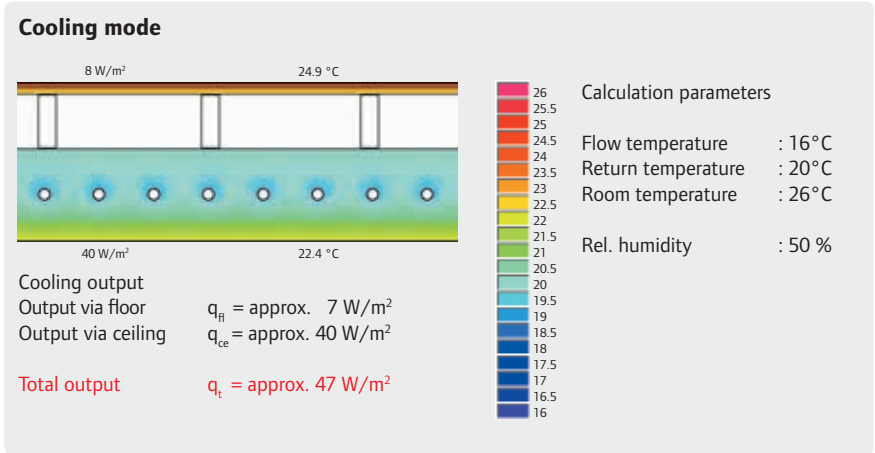
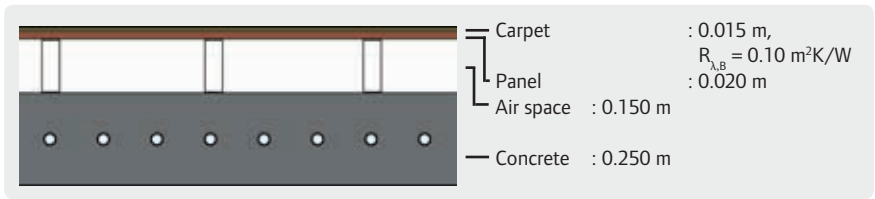

3.5.4 Reduction in output through acoustic measures, insulating layers or voids

Floor construction

As demonstrated in the above calculations, building designers need to be aware of the fact that output via the floor is reduced significantly if a raised floor is installed. This is particularly important if the system is meant to cover a large heating load. The necessity of a raised floor should be considered very carefully. Conventional impact sound insulation also obstructs heat emission via the floor. If impact sound insulation is essential, materials with adequate impact sound characteristics, yet good heat transmission, should be selected.

Ceiling construction

It should be noted that, due to their impact on heat transfer, enclosed suspended ceilings are usually not suitable in conjunction with TABS. Convection heat transfer is restricted and subject to long time lags. Acoustic plaster covering the whole ceiling has the same effect as a suspended ceiling.

The TABS system can achieve maximum output in ceilings without any lining (plaster). However, the acoustic performance of such exposed (“hard”) surfaces is less favourable. To comply with acoustic requirements, the installation of ceiling panels should be considered. Naturally, these devices also have some effect on the performance of TABS, depending on their area coverage. The same applies to suspended louvered ceilings. While performance is reduced, general functionality is maintained.

3.6 Dynamic considerations

Conventional heating/cooling systems can be designed to deal with heating or cooling loads as soon as they arise. In principle, such systems can be designed based on steady-state calculations.

In contrast, TABS will not be able to fully dissipate loads at all times. Diurnal temperatures will therefore vary depending on the available thermal mass and actual cooling loads. To estimate these fluctuations, the variation of loads and their dissipation over time must be considered. The ability to make explicit statements during the design phase about how a building with TABS will behave, requires calculations that take into account the inertia of the thermal mass of the building. It is therefore important to consider the dynamic behaviour of all factors that influence the temperatures inside the building.

Important design advice: an acoustician should be involved in the design phase

Depending on the free area, performance is reduced by up to 30 % for up to 60 % enclosed ceiling (see “Acoustics” chapter). In order to avoid loss of performance, it may be useful to consider implementing acoustic measures on walls, rather than the ceiling. Further options for locating acoustic measures include office cabinets, partitions and furniture.

In future, new sound-absorbing structures may become available that can be installed on the ceiling without significantly restricting thermal output via the ceiling.

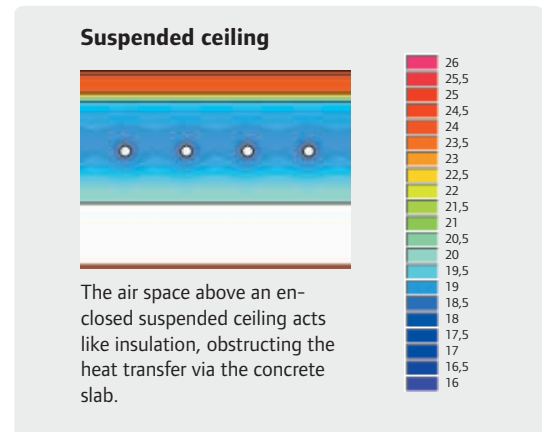

These parameters include:

- The weather (in particular solar radiation and ambient temperatures)
- Structural aspects (heavy or light-weight construction, heat transfer coefficient of the façade and shading devices)
- Internal loads (from occupants, lighting and equipment)
- User behaviour and perhaps further significant factors

In order to predict potential violations of the comfort zone and their frequency, the dynamic behaviour of all the parameters listed above should be taken into account. This can be achieved using thermal simulation.

Simulation software is no substitute for design advice from a building services or building physics specialist.

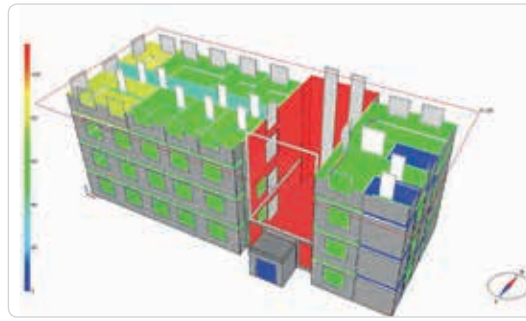

Cooling load simulation of an office building

3.6.1 Thermal building simulation for different building types

Based on simulation results, the thermal behaviour of different building types is explained. The room or operative temperature (dry resultant temperature), with or without TABS, during an extreme hot spell is examined.

The program TRNSYS version 15 was used for the dynamic calculations described below. The associated multi-zone building model (TRNSYS type 56) already contains a module for entering the boundary conditions for TABS. The calculations are based on the Uponor Contec system (PE-Xa pipe with dimensions of 20 mm, pipe distance 150 mm). The system covers 80 % of the floor area.

The following charts show different temperature curves illustrating the thermal behaviour of a space during a 5-day hot spell. The assumed external temperature is also shown. It fluctuates between 16 and 32 °C. The charts do not show the high direct solar radiation assumed for the simulation, which naturally is another crucial factor for the thermal behaviour of the building under the extreme conditions examined in this example.

The simulation focuses on the cooling mode, since this is the main area of application for TABS.

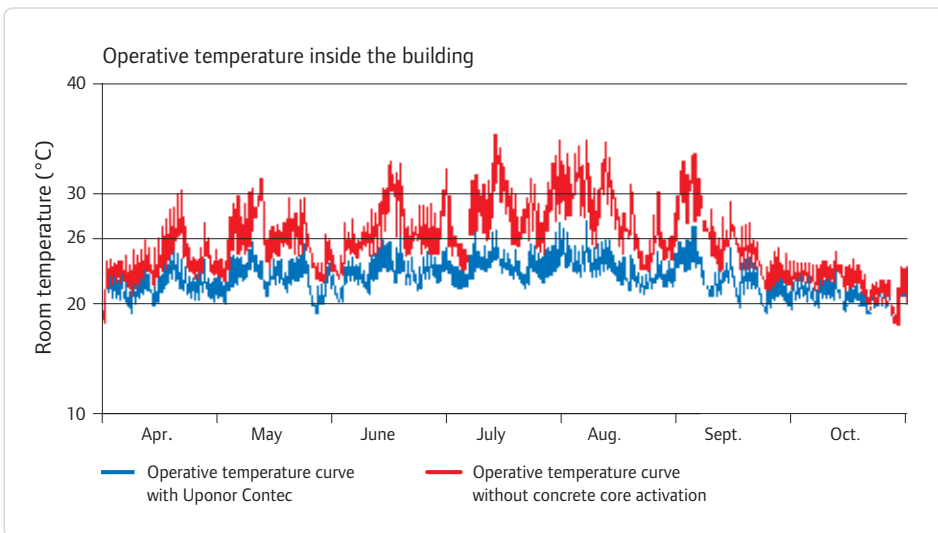

Comparison of simulated dry resultant temperature curves:
In summer, concrete core activation can effectively counteract overheating of the building – apart from isolated occasions, the room temperature remains below 26 °C

3.6.2 Thermal building simulation for building with floor-to-ceiling glazing

The first building to be examined is a modern office building with floor-to-ceiling glazing (low-E glazing with a heat transfer coefficient $U = 1.1 \text{ W/m}^2\text{K}$, total solar heat gain coefficient $g = 0.6$). The thickness of the concrete slab is 300 mm, with a raised access floor on top. The floor is covered with carpet. Apart from the heavy-weight ceiling, the rest of the interior is of light-weight construction. The partitions consist of plaster-board with mineral fibre insulation.



The building is equipped with automatic shading devices (external blinds, shading reduction factor $z = 0.25$), which limit the presence of direct solar radiation. The space examined is a south-facing office with a floor area of 20 m^2 . Internal loads during the occupied period (8am-6pm) are assumed to originate from the heat gain from 2 persons, 2 PCs with monitor, a printer and lighting.

Different variants were examined:

- A) No TABS, natural ventilation
- B) TABS, natural ventilation
- C) TABS plus mechanical ventilation

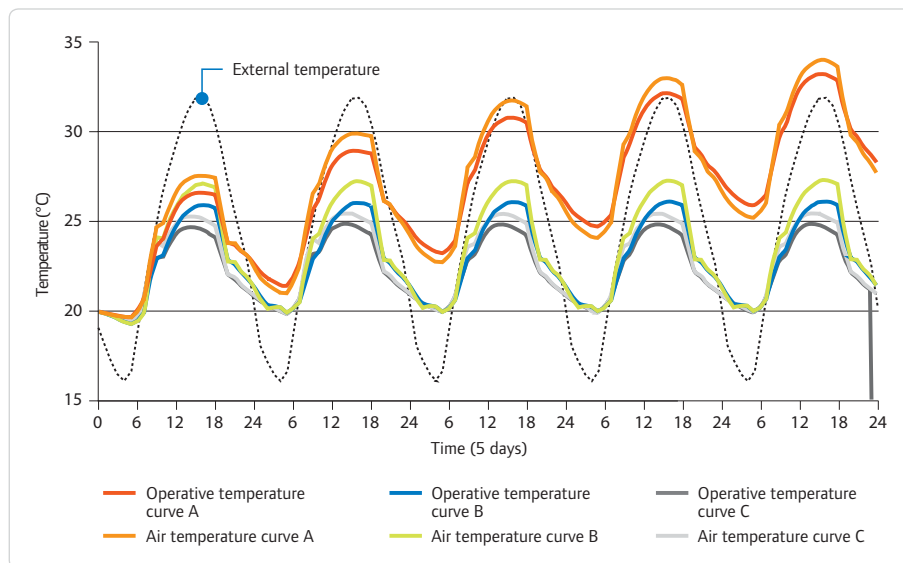

- A) Some form of cooling is essential in this building. During the 5-day hot spell, the temperature inside the building reaches 34°C .
- B) TABS is able to prevent successive temperature rise inside the building. The temperature inside the building remains approximately within the range of 20 to 26°C .
- C) If additional mechanical ventilation with 2 air changes per hour and a supply air temperature of 18°C is used, the temperature inside the building can be maintained within an even narrower temperature range.

3.6.3 Thermal building simulation for a building with high thermal mass (façade with double-skin masonry wall)

The second example is an office building with high thermal mass in the form of heavy-weight ceilings and external walls. Instead of floor-to-ceiling glazing, the building features a double-skin masonry wall construction (solid brick wall $U = 0.4 \text{ W/m}^2\text{K}$). The window area ratio (low-E glazing $U = 1.3 \text{ W/m}^2\text{K}$, $g = 0.59$) of the façade is approximately 60 %.



The concrete slab with a thickness of 240 mm is covered with bonded screed and carpet. The internal walls are constructed from sand-lime brick with a thickness of 11.5 cm. Internal loads during the occupied period (8am-6pm) are assumed to originate from the heat gain from 2 persons, 2 PCs with monitor, a printer and lighting.

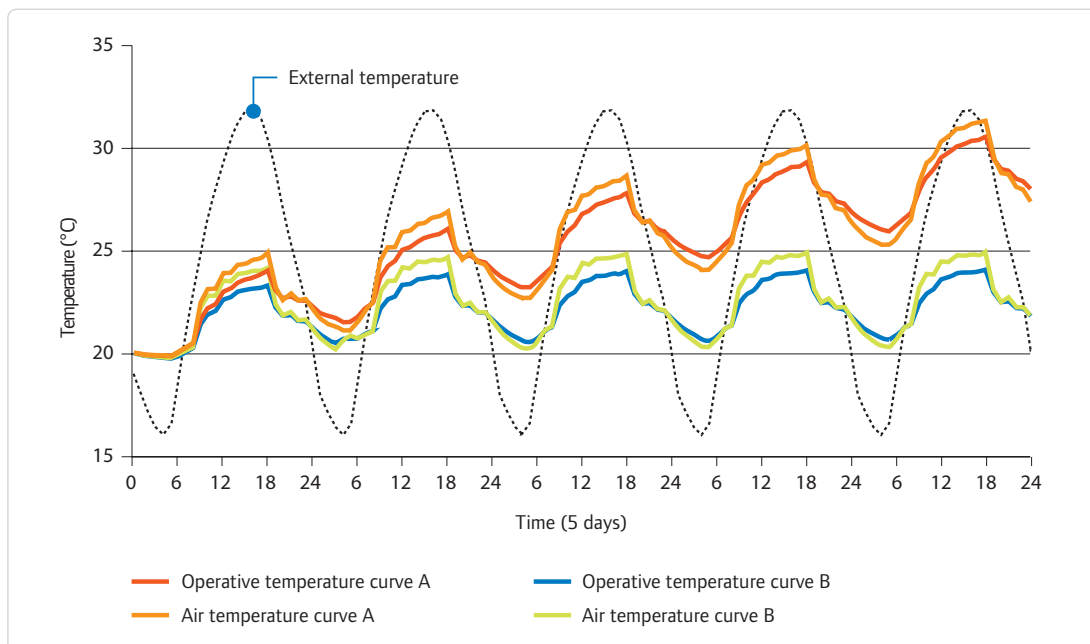

A) Due to the higher thermal mass and the smaller window area ratio, compared with the previous building this building is less sensitive to internal and exterior loads. Nevertheless, by the 5th day of the hot spell, the internal temperature has reached more than 30 °C.

B) Concrete core activation prevents successive temperature rise inside the building. Due to concrete core activation, the operative temperature inside the building remains within a narrow range of approx. 21 to 24 °C.

3.6.4 When should simulation be used?

The advantage of tools such as simulation programs is that they can help optimise the overall concept and uncover potential design weaknesses. Simulation is always recommended for buildings with large load fluctuations, potentially high moisture load and exposed room locations. However, simulation is not necessarily required for all buildings with TABS.

Based on the experience gained in the design and operation of existing systems, statements about the likely performance of TABS in the respective building can be made without project-specific dynamic calculation. For example, steady-state calculations provide information about the achievable output and enable dimensioning of the pipes. Most existing projects with TABS have been constructed on this basis. Provided the design remains within the limits set by this technology, satisfactory function and a gain in comfort is guaranteed.

An adjustment phase after commissioning of the TABS system is likely to be required with or without simulation.

Conclusions from the above simulations

- Uponor Contec can be used for different types of building
- In buildings with high loads, TABS should at least be able to compensate a base load, so that any additional ventilation system that may be required can be designed smaller
- Due to advantageous investment and operating costs, TABS can provide a comfortable working environment in buildings where normally, for cost reasons, no cooling would be provided

Construction methods

The flexibility and adaptability of the Uponor Contec system is demonstrated by the fact that it has already been installed in all possible slab or wall constructions. Whether the selected construction method is cast in situ, filigree (part precast), fully precast or permanent formwork, the Uponor Contec system is flexible enough to meet project demands in conjunction with the related variations of slab constructions.

4.1 In situ slab construction

In situ concrete slabs are currently the most common type of floor construction for office buildings. The Contec system components, modules, mesh hooks and the patented ceiling lead-through elements were developed specifically for this type of slab.

To find out more about the patented mesh hook element method from Uponor, and its advantages, see chapter 5, section 5.2: "Installation steps".

The Uponor Contec system is typically designed and installed in situ in modules for faster, safer and more accurate installation.

In this section the most common floor and wall constructions are examined. To illustrate these construction methods, some reference cases of previous projects equipped with the Uponor Contec system are shown.

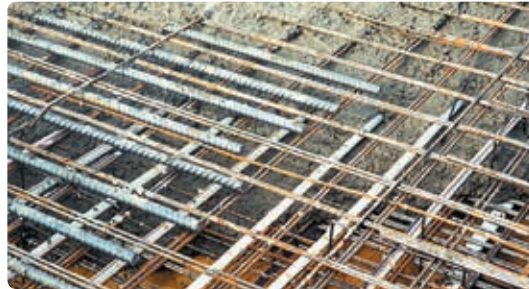

The Uponor Contec modules are installed in the centre of the floor



In situ concrete casting

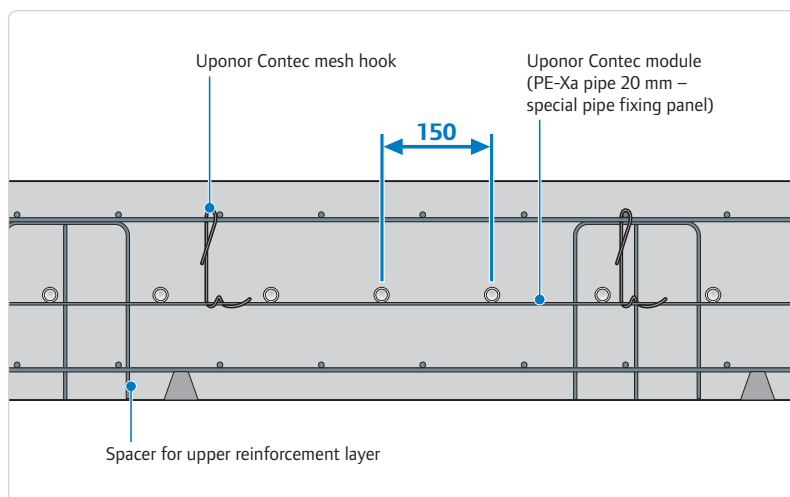

Uponor Contec, mesh hook element method

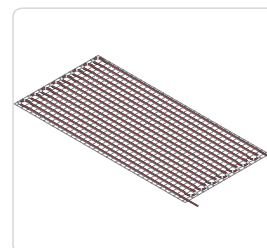

Modular design

4.2 Post-tension concrete slab

In order to overcome the natural weakness that concrete has in relation to tension, post-tension slab can be used for the length of the floor. This method is called pre-stressing and means that the slab has been pre-stressed to increase its strength (called, in this sense, a post-tension concrete slab).

The advantages of a post-tension concrete slab include reduced construction costs and lighter construction due to a thinner slab. The fact that the construction itself is thinner provides cost savings in foundation and reduction in building heights, thus resulting in reduced exterior finishing costs. The Uponor Contec system has already been incorporated into this construction method in various projects.



The Uponor Contec modules are installed in the centre of the floor

4.3 Filigree floor slab

The Uponor Contec modules are also suitable for installation in filigree slab floors as they allow for fast installation. In this case, the mesh carriers, which normally serve as spacers for the upper reinforcement layer, are shortened so that they can carry the medium reinforcement layer and the Contec modules.

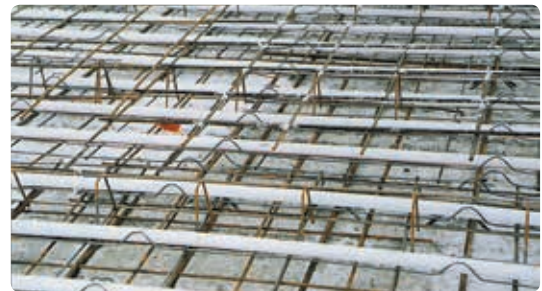

Uponor Contec modules placed on mesh carriers

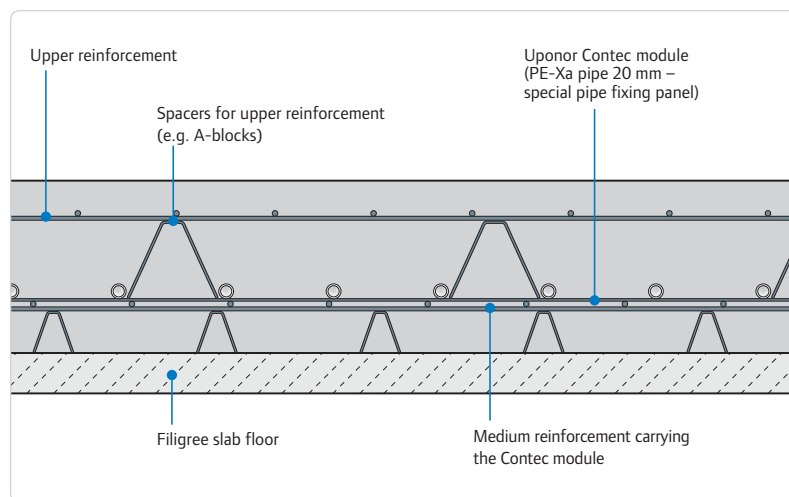

Uponor Contec in filigree slab floors

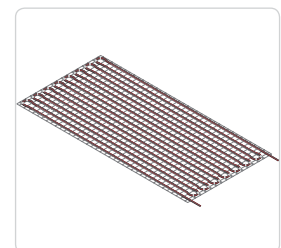

Modular design

4.4 Precast concrete floors

4.4.1 Common precast elements

The installation of modules in precast concrete structures is a widely used method. The modular design enables the concrete element manufacturer to supply the precast parts with fully integrated concrete core activation to the site on time.



Uponor Contec modules incorporated into precast concrete slab



Crane transporting the precast concrete slab element to the correct position

4.4.2 Hollow core

Another precast floor construction is the hollow core slab. This type of precast slab constructed from prestressed concrete comes with voids of tubular shape along the full length of the slab. This characteristic of hollow core slab makes it lighter than the typical slab construction, thus providing advantages of reduced material and transportation costs, as well as fast installation.

This type of slab construction is popular in countries with high penetration of precast concrete solutions and with low seismic activity.



Precast hollow core slab, equipped with concrete core activation and distribution lines, as installed in the University of Bochum

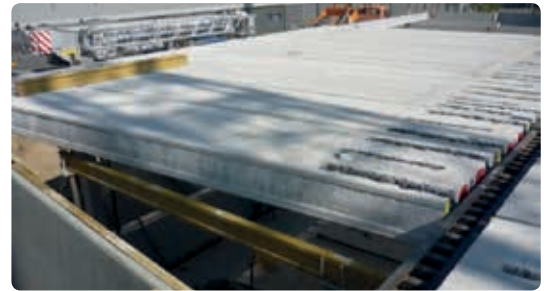

Uponor Contec modules incorporated into precast hollow core

4.5 Permanent formwork slabs

Over the last decades there have been many attempts by structural engineers to decrease the weight of the slabs. As seen above, one solution was the introduction of precast hollow core slabs. The limitations of such slabs due to lack of flexibility and limited architectural freedom has led engineers to pursue other solutions. One of these is permanent formwork or lost shuttering. Trapezoidal metal sheet floors, often called metal deck or ComFlor®, constitute two examples of these types of installations.

Specifically in relation to floors with metal sheets such as trapezoidal sheet metal floors, the output capacity of the radiant heating/cooling system could be increased by almost 50 %. However, in this case, the ability of the floor to save energy is compromised. The Uponor Contec modules are typically installed on top of the trapezoidal metal sheet.



Uponor Contec installed in metal deck

Nevertheless, in order to utilise the higher capacity of floors with metal sheets and at the same time benefit from the energy saving advantages of screed and concrete, the Contec modules could be installed inside the correspondent screed, above the concrete layer.

4.6 Special applications

Some of the more than 100 projects realized with Uponor Contec so far, have involved a number of special floor constructions, for which Uponor provided support during design and implementation.

Since the focus in the last decades has been on minimizing the weight of slabs, biaxial slabs with hollow cavities have been introduced. The purpose of these hollow

cavities (filled with spheres, other elements or kept void) is to displace concrete from areas in the span in which it has no structural benefit. Some common voided biaxial slab systems around the world are: BubbleDeck®, Cobiax®, U-Boot®, ripped slabs, waffle slabs and polystyrene voiding blocks. Contec has been used to thermally activate the slabs in these voided biaxial slab systems.

4.6.1 BubbleDeck®

Uponor has worked together with BubbleDeck® to incorporate Contec modules in the lower part of the slab. The piping can be installed either at the precast site or on site.

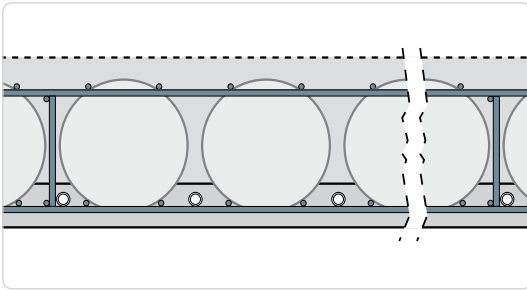

Floor section of BubbleDeck® (Type BD 230) with Uponor Contec



BubbleDeck® and Uponor Contec as precast element

4.6.2 Cobiax®

In this system, hollow bodies of elliptically shaped plastic are mounted with a light metal mesh between the upper and lower reinforcement. This creates a long-spanning, biaxial slab without beams, reducing weight and thus support structures and foundation design.



Floor section of Cobiax® modules with Uponor Contec



Cobiax® modules, coupled with Uponor Contec system as precast modules

In collaboration with Hanson, Uponor developed a concept to embed Uponor PE-Xa piping inside the Omnia precast floor panel, equipped with Cobiax void forming. The result was the Coolslab® system.

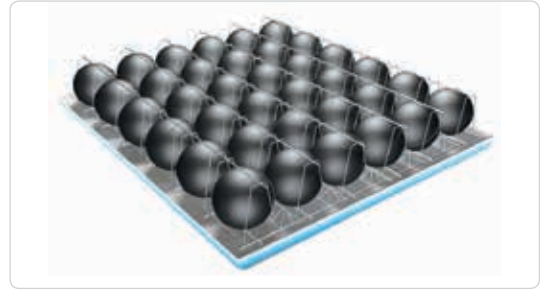

The Coolslab® system, as developed by Hanson and Uponor. The Uponor Contec system is prefabricated in the precast section

4.6.3 U-Boot®

The reduction of transportation costs and CO₂ emissions was among the main driving forces for the invention of another system of void formers.

This system, known as U-Boot®, consists of recycled polypropylene formwork. The U-Boot® system creates mushroom pillars, which are mounted into the slab,

allowing lighter construction with large span and no beams, thus also minimising material and transportation costs. The biggest advantage of the system is that it is stackable and that because of its shape, the U-Boot® creates a grid of orthogonal “I” beams, so that reinforcement can be calculated according to widely used international and local standards.

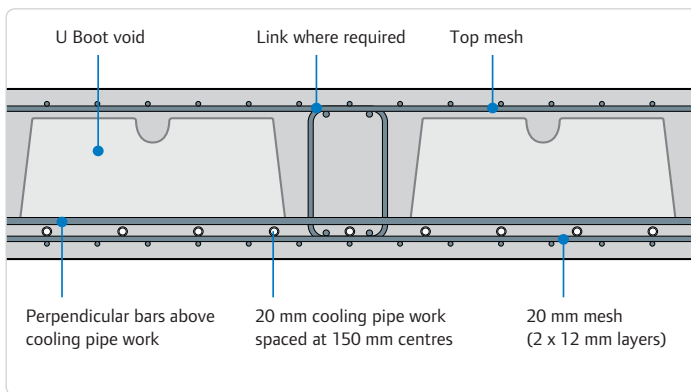

Floor section of U-Boot® with Uponor Contec system



Uponor Contec installation, concreting and U-Boot modules installation

4.6.4 Ribbed and waffle slabs

Ribbed and waffle slabs are further types of voided slab. Contec has also been used in these slab types as a special addition to thermally activate the slab. One example for these methods is the waffle slab utilising the SKYRAIL® system.

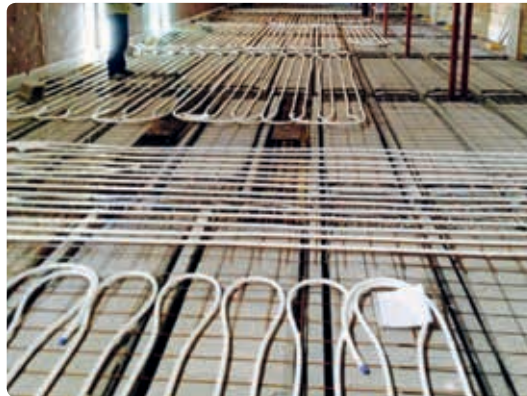

Uponor Contec system installation with ribbed slab

4.6.5 Polystyrene voiding blocks

Another voided slab construction method that aims to reduce the weight of slabs is the polystyrene voiding blocks method: blocks of polystyrene are mounted in the floor in order to reduce the amount of concrete poured on site.

The Omnicore® system belongs to this method and was developed by Hanson and Uponor as a variation of the Coolslab® system. In this system, blocks of polystyrene are mounted into the upper part of the precast section. That way, the amount of required in situ concrete is reduced, thus decreasing the total weight of the floor.

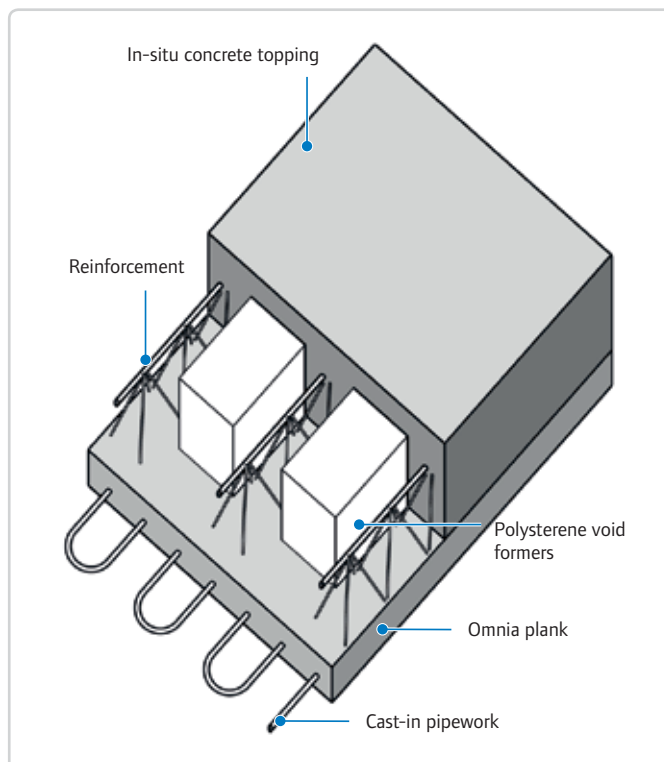

Coolslab®, developed by Uponor and Hanson, as proposed for the Manchester Metropolitan University (MMU) project

Source: S. Doody et al. "The Development of an 'Activated' Thermal Mass pre-cast structural floor with an Architecturally Fair Faced finish, to deliver Space Conditioning from Ground Sourced Cooling", Feilden Clegg Bradley Studios, Paper submitted as Practice-located Research for the RIBA President's Award for Research 2010.

4.6.6 Renovation of historical buildings

In the historic docks of Hamburg, a number of old warehouses have been converted into modern office buildings. In some of these buildings, concrete core activation has been successfully integrated into the old

building structure using a tailor-made construction method. As the room ceilings were rather low, there was no space available for air channels.



Hamburg docklands



Tailor-made installation between ceiling beams

4.7 Wall installation

In buildings with glass façades, concrete slabs are often the only components providing thermal storage mass. However, Uponor Contec modules for concrete core activation can also be integrated into solid heavy weight internal walls. Combined with concrete core activated floors, such solutions significantly increase the heating/cooling performance of the building. They have the additional positive effect of allowing wet shells to dry much quicker with heating.

The Uponor Contec system can be designed and installed in modules for in situ installation, bringing all the advantages of module installation as illustrated in section 4.1. Apart from that, the Uponor Contec system can be installed horizontally or vertically and in all possible wall heights, thus providing absolute installation flexibility.



Uponor Contec modules installed in wall



Uponor Contec modules installed in wall

Installation guidelines

5.1 Delivery of modules

Depending on the size and type, the Contec modules are supplied to the building site in vertical or horizontal packs on non-returnable transport devices. The module packs are unloaded by crane and stored on site until installation. During storage, they must be protected against impact and weather.



Contec module pack, upright version

For prolonged storage at the construction site (> 30 days), ensure that the modules are not exposed to direct sunlight (UV radiation).



Contec module pack, horizontal version (Q131 Contec modules)

Crane transport of Contec module pack

The instructions below must be strictly adhered to in order to prevent injury to persons and damage to property.

Module pack with vertical Contec modules

The module pack consists of a non-returnable transport device to which the Contec modules are secured. Each transport device can hold up to 35 modules. Dimensions of the empty transport device are as follows: L/W/H approx. 3.50 m/1.20 m/2.00 m. The maximum weight of a transport device with 35 modules of size 6.30 m x 2.40 m is approx. 1400 kg.

For crane transport, position the module packs on firm and level ground. Attach the module pack to the crane hook with the straps provided. Lift the module pack by crane to the respective installation level and place it on a level surface with the necessary load bearing capacity.

Remove the transport straps. The individual Contec modules can now be removed from the transport device.



Proper crane transport of a Contec module pack with upright modules

Module pack with horizontal Contec modules

Contec modules with Q 131 steel mesh reinforcement are transported and stored in horizontal stacks on non-returnable pallets. The rules for handling and crane transport are the same as for upright module packs. Again, do not change the attachment of the lifting straps as the load might otherwise become dislodged when lifted.

Important!

- Always place the module packs on firm and level ground. Observe the necessary load capacity.
- Do not change the attachment of the straps to the transport device (seen from the top: threaded through the third loop of the smallest module).
- Do not attach any lifting tackle to the non-returnable transport device.
- Do not attach more than one module pack at a time to the crane hook.
- Never stand under lifted module packs.
- When removing Contec modules from upright module packs, take one module from one side and the next module from the other side to prevent the pack from toppling over.

5.2. Installation steps

In in-situ concrete slabs

The construction process, including installation of the concrete core activation system, involves the following steps:



1. Installation of the floor shuttering by the building contractor.



2. The installer nails the ceiling pipe lead-through elements to the shuttering according to the installation plan.



3. The building contractor positions the lower reinforcement layer and the associated spacers.



4. A crane lifts a module transport frame onto the floor.



5. The installer removes the modules from the transport box, then distributes and aligns them on the centre reinforcement layer according to the installation plan. For that purpose, the modules are supplied with a label that indicates size and type.



6. Several modules may be connected via couplings to form a cooling/heating loop. Connection pipes may be extended in the same way.

The ends of the connection pipes are then covered with a protective tube and pushed through the ceiling pipe lead-through elements.



7. To carry out hydraulic pressure tests according to the pressure test protocol, the pipe ends protruding from the ceiling lead-through elements are equipped with appropriate Uponor adapter fittings, a pressure gauge and drain valves.

Before and during concrete pouring, all circuits must be

pressurised (water or air) and the pressure monitored. This pressure test must be documented. Prior to commissioning, the pipe registers must be subjected to a final leakage test at medium operating level. This is carried out according to the official contract procedure for building works and with a test pressure of at least 1.3 times the operating pressure.



8. The building contractor positions the spacers for the upper reinforcement layer and the reinforcement.



9. The modules are lifted via the Uponor Contec Hooks, and the open brackets are suspended from the upper reinforcement.

The modules are secured (for example, to prevent rising during concrete pouring) in the neutral zone by bending the Uponor Contec Hooks. Four hooks per m² stabilise the module in the slab.



10. The concrete is poured. Vibrators for concreting are allowed and will not affect/damage the pipe.



11. Once the concrete has cured and the shuttering has been removed, the pressure test fittings can be removed and the connection pipes pulled down through the ceiling lead-through element. The red straps at the openings of the ceiling lead-through elements indicate the direction from which the pipe was inserted.



12. The installer thus knows immediately from which side he has to pull the connection pipes.

Finally, loops are connected to the distribution lines or manifolds. The complete installation is subjected to a final pressure test. This final test must be documented.

The procedure described above illustrates the need for excellent coordination between the different trades. To ensure success-

ful installation of the concrete core activation system, the installer must coordinate his activities with that of the concrete contractor.

Important planning notes:

Water filled pipelines must be protected against frost.

Filigree floors

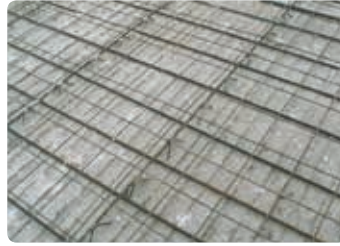

1. The central reinforcement layer is laid by the building contractor, for example in the form of mesh reinforcement.



2. The installer removes the modules from the transport box, places them on the floor, then distributes and aligns them on the central reinforcement layer according to the installation plan.

3. In contrast to in-situ concrete slabs, the modules are already in their final position in the centre of the slab, and therefore do not have to be positioned in the centre using the support element method. However, they should be secured on the reinforcement against shifting.



4. In filigree floors, no ceiling lead-through elements are used. Openings in the floor below can simply be drilled through the filigree slab. The connection pipe ends are covered with a protective tube and pushed downwards.

5. The building contractor positions the spacers for the upper reinforcement layer and then lays and fixes the reinforcement.

6. Before the concrete is poured, all cooling/heating circuits must be pressurised and pressurisation checked.

For less common construction methods, specialised construction steps should be followed. Please see chapter 4, "Construction Methods".

5.3 General notes on installation according ISO 11855

Installation of piping

Storage and transport

The pipes shall be transported, stored and handled in such a way as to be:

- Protected from anything which could damage them
- In the case of plastic pipes, stored out of direct sunlight

Clearance area

The pipes are placed more than:

- 50 mm distance from vertical structures of plastic pipes, stored out of direct sunlight
- 200 mm distance from smoke ducts and open fireplaces, open or walled shafts, lift wells

Bending radius

Use only a bending radius equal to the radius of pipe bending recommended by the system supplier.

Couplings

If any couplings are installed in the floor construction during pipe installation, the exact location of all couplings within the floor construction must be accurately designated and recorded in the construction drawing.

Attachment of pipes

The pipes and their attachment systems are secured such that their horizontal and vertical positions are maintained as planned. The vertical deviation upwards of the pipes before and after application of the screed should not exceed 5 mm at any point. The horizontal deviation of the specified pipe spacing in the heating circuit should not exceed ± 10 mm at the attachment points. These requirements are not applicable in the area of bends and deflections. The attachment spacing necessary to comply with these requirements is dependent on the tube materials, dimensions and systems.

More frequent attachments provide greater security of pipe positioning. Spacing of the attachments depends on the system applied. Experience has shown that systems with individual attachments necessitate spacing of approximately 50 cm in order to comply with the above-mentioned requirements.

Reinforcement

Reinforcement mesh used for TABS pipe attachment must be in accordance with the relevant standards. National standards should be used until a European standard is available.

Leak test

The leak test may be performed using water or compressed air.

Prior to the laying of the screed, the heating and cooling circuits should be checked for leaks by means of a pressure test. The test pressure must be not less than 4 bar, or not greater than 6 bar for standard systems. In the case of gush asphalt, the pipes must be depressurised during the asphalt laying process. The absence of leaks and the test pressure should be specified in a test record. If there is a danger of freezing, appropriate measures, such as the use of frost protection or the conditioning of the building, should be undertaken. When normal system operation begins, any frost protection fluids may be drained and disposed of in compliance with the relevant national health and safety regulations, then flushed 3 times with clean water.

Heating and cooling systems embedded in ceilings and walls

General structural preconditions

Heating/cooling systems can be installed upon or within walls or ceilings constructed from masonry, concrete or prefabricated lightweight materials. The following requirements must be fulfilled:

- Walls or ceilings must be structurally capable of supporting the system
- Tolerances, levels and datums must comply with national standards where these exist
- All electric cables, ducts or service pipes must be installed and tested before heating/cooling work commences
- Where settlement joints exist in walls or ceilings, appropriate measures must be identified and work carried out before the heating/cooling work commences
- In all cases, windows and external doors must be installed before work continues

Insulation

The insulation for ceiling and wall heating/cooling systems that depend on an adjacent room or on the outside environment may be divided into sections of layers e.g. in the case of outside walls into a layer directly behind the system and another one outside.

Thermal resistance $R_{\lambda,ins}$ may be determined by taking into account the effective thermal resistance of the building structure. Wall heating and cooling systems embedded in interior walls may be constructed with or without insulation, depending on their use.

Maximum heating water flow temperatures

Depending on material used, the following maximum flow temperatures are recommended:

- Plaster based on gypsum or lime $v_{des,max} = 50\text{ °C}$
- Loam mortar plaster $v_{des,max} = 50\text{ °C}$
- Plaster based on lime-cement $v_{des,max} = 70\text{ °C}$
- Prefabricated building slab of hard plaster $v_{des,max} = 50\text{ °C}$

Corrosion prevention

Oxygen barrier layer

One way to reduce corrosion problems when combining plastic pipes with corrodible materials in heating installations, is to use plastic pipes carrying an oxygen barrier layer. When tested in accordance with ISO 17455 method I or method II, as applicable, pipes must meet the requirement of oxygen permeability $\leq 0.32\text{ mg}/(\text{m}^2 \times \text{d})$ at a test (water) temperature of 40 °C .

Specimen preparation

Water accumulation is carried out on a pipe section of at least 20 m in length. 10 % of the length is wound around a core. The coil should show a bending radius equal to the bending radius recommended by the system supplier. The wound pipe section is fixed on the core. After assembling, a relaxation time of 24 hours without any load takes place (outside the water bath). Afterwards, the coil is stored in a water bath (tap water) with a water temperature of 20 °C . During storage, the pipe must be filled with water and both ends of the pipe must be outside the water bath without any contact to the water. After the storage time, the coil will be taken out of the water bath in order to dry the outside surface of the pipe. Both pipe ends are closed, the water remains inside the pipe. The drying of the outside surface of the pipe should take place over a period of 28 days under standard atmosphere conditions according to EN ISO 291.

Note:

The unit $\text{mg}/(\text{m}^2 \times \text{d})$ enables results that are independent of the tested dimension of the pipe.

5.4 Test protocol

Pressure test

Pressure testing according to EN 11855:

The circuits are checked for leaks by means of a water or air pressure test. The pressure test must be carried out after the system has been completed but before the pipework is covered.

The loops must be completely filled and purged of air before pressurised water-testing takes place.

For systems with a concrete layer, leak-testing should be carried out immediately before the screed layering, and the test pressure must be maintained throughout the laying of the screed.

The test pressure must be twice the working pressure with a minimum of 4 bar and a maximum of 6 bar.

If there is a danger of freezing, appropriate measures, such as the use of frost protection or the conditioning of the building, should be undertaken. If no further frost protection is necessary for the normal operation of the system, the frost protective is drained and the system flushed using at least 3 changes of water.

It is important to maintain water temperature as constant as possible throughout the test. Changes in the water temperature will alter the pressure within the system.

All pressure-measuring instruments used, must be reliably accurate to 0.1 bar (10KPa). The test pressure must not drop by more than 0.2 bar (20KPa) and there should be no leaks.

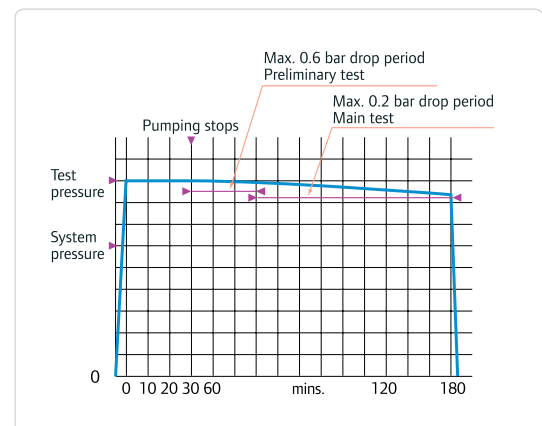

Pressure test report

Pressure test for underfloor heating system in accordance with DIN EN 1264-4

Project: _____

Project phase: _____

Person responsible for inspection: _____

Max. allowable operating pressure: = _____ bar
(with reference to lowermost point of system)

The balance between ambient temperature and filling water temperature should be taken into account by a corresponding waiting period after achievement of test pressure. The test pressure must be recovered as required after the waiting period.

Note: By the air test the sufficient time for the relaxation of the pressed air temperature and volume is needed.

Preliminary test

Test start: _____ , _____
Date Time

Test pressure: _____ bar
(max. 6 bar)

Test end: _____ , _____
Date, Time (max. drop in pressure 0.6 bar)

Test pressure: _____ bar

Main test

Test start: _____ , _____
Date Time

Test pressure: _____ bar

Test end: _____ , _____
Date, Time

Test pressure: _____ bar

Pressure loss during the main test : _____ bar (max. 0.2 bar)

It was determined, at the end of the test period, that there were no leaks in the above-mentioned system.

Confirmation

Building owner/Customer:
Stamp/Signature

Site management/Architect:
Stamp/Signature

Heating company:
Stamp/Signature

Place, Date

Place, Date

Place, Date

Systems

The efficiency of Uponor Contec is guaranteed by a number of special features, including:

- Modules, always factory assembled, equipped with Uponor pipes for smooth installation and fast construction progress
- High performance thanks to pipe laying that is compliant with all relevant standards
- Optimised pipe positioning, with or without patented Uponor mesh hooks
- Uponor PE-Xa pipe with outer protective jacket
- Patented system components including ceiling pipe lead-through elements for pressure testing without damage to the formwork, and special pipe fixing panels for modular installation

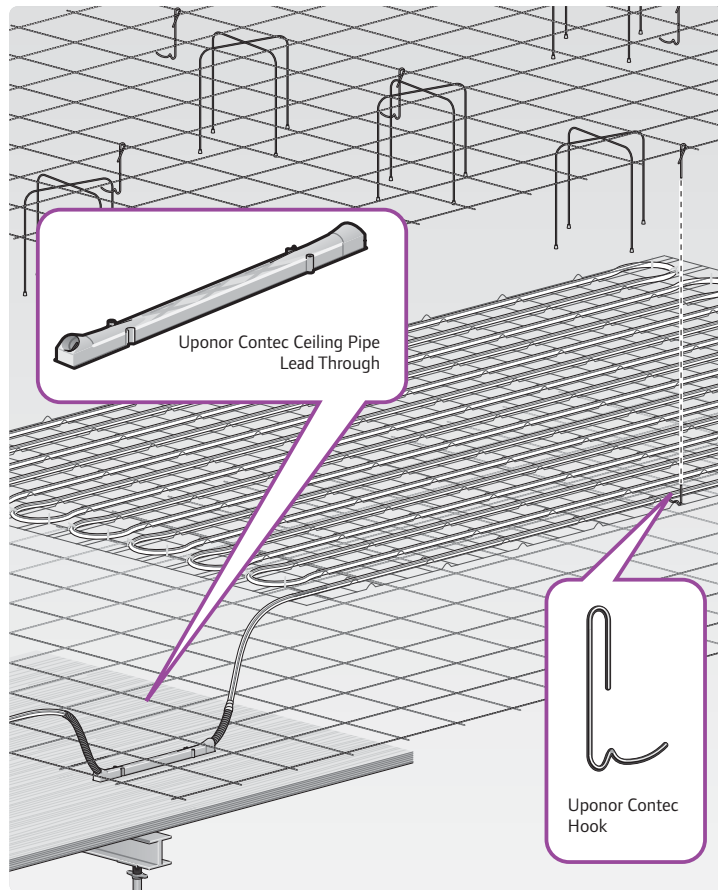

Exploded view of an in-situ concrete slab with Uponor Contec

6.1 Uponor BIC (Built-In Clamp) System

This special pipe carrier mat is pre-equipped in the factory with Uponor pipes.

It is a lightweight mat with 4 mm transversal wires and pairs of 3 mm longitudinal wires containing pipe clips that hold the Uponor pipe system at the optimum installation distance.

Each Uponor Contec module contains integrated pipes for connection to the distribution pipe or manifold. During the design phase, suitable Uponor Contec modules are allocated to the structural components in which concrete core activation is to be used.

Modules are available in different sizes to cater for site-specific conditions. The following standard widths are available: 1.2 m, 1.5 m, 1.8 m, 2.1 m and 2.4 m. Lengths are variable depending on the project but maximum length is 13.5 m.

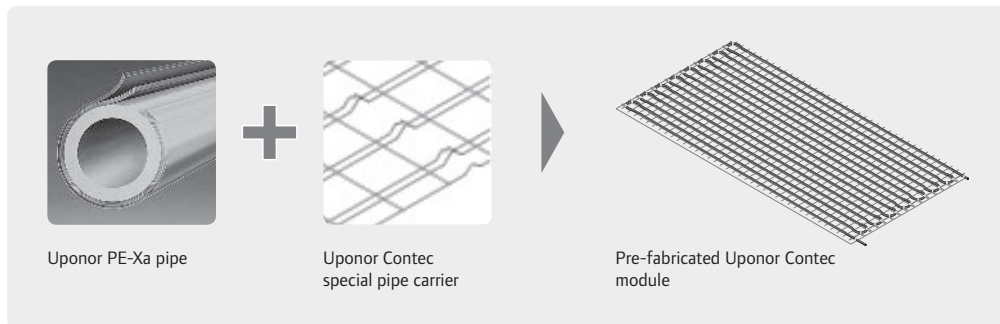

6.2 Uponor Q system

The pipe carrier mat, with 5 mm wires in a 150x150 mm grid, is pre-equipped in the factory with Uponor pipes fixed at the optimum installation distance.

Each Uponor Contec module contains integrated pipes for connection to the distribution pipe or manifold.

During the design phase, suitable Contec modules are allocated to the structural components in which concrete core activation is to be used.

Modules are available in different sizes to cater for site-specific conditions.

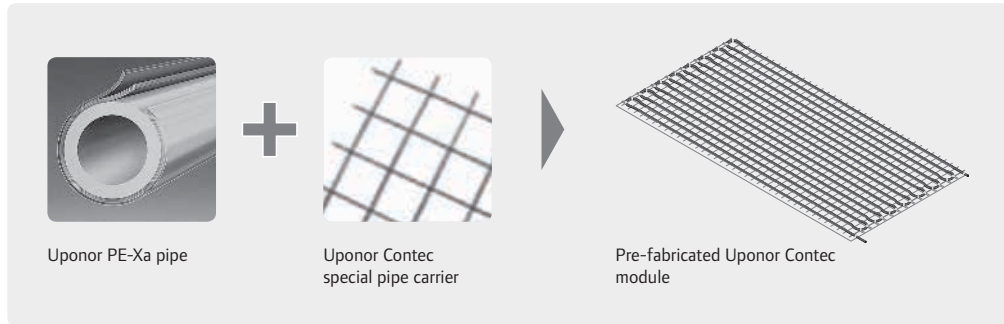

6.3 Uponor Contec ON system

The Uponor close-to-surface concrete core activation system is specifically designed for a fast response to load changes and greater heating/cooling demand. In buildings with classic concrete core activation systems that provide effective thermal storage, the Contec On system is useful to provide a complementary fast-response system that is able to deal with peak loads and also allows for temperature regulation in individual rooms.

The Uponor Contec ON Bracket, made of plastic, guarantees that the pipes are installed exactly at the intended level, a few millimetres below the surface of the ceiling. The Uponor Bracket also acts as a spacer for the positioning of the lower reinforcement layer.

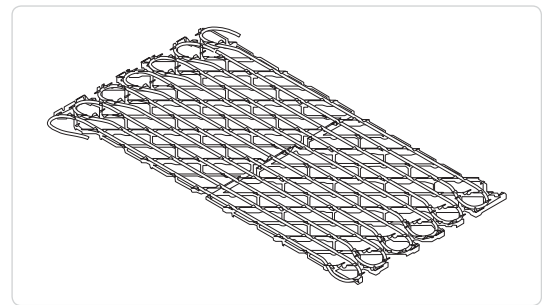

Uponor Contec ON module

Uponor Contec ON is available in the standard version (pipe spacing 170 mm) designed mainly for installation across the entire ceiling. In addition, a high performance version (pipe spacing 85 mm) is available. This is intended for areas around the edges of a room where a high output rate across a small surface needs to be achieved.

Uponor Contec ON standard

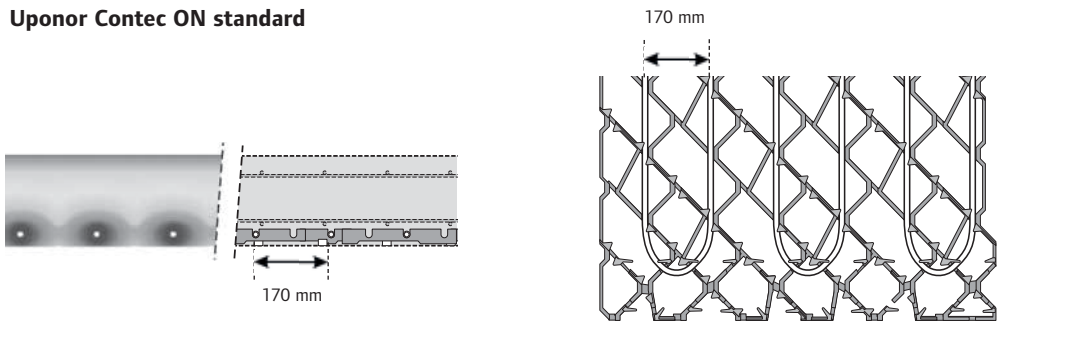

Uponor Contec ON high performance

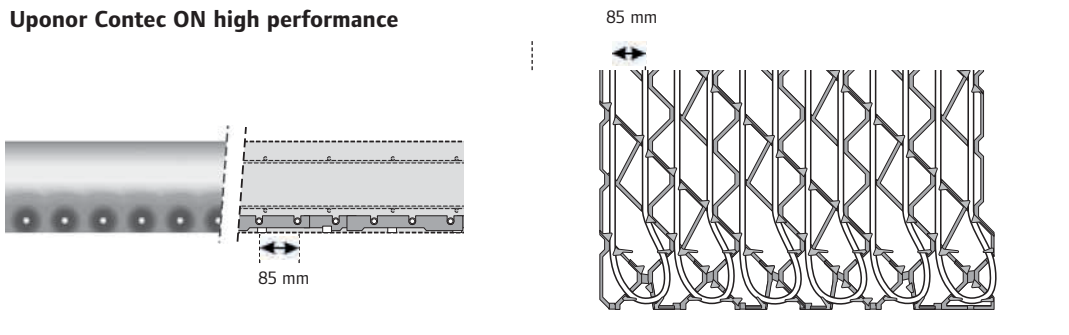

The perfect match: Uponor Contec and Uponor Contec ON

As the Uponor Contec ON standard version is designed to respond with a certain delay, it requires availability of sufficient energy for cooling or heating during peak demand time. The system is suitable for operation with renewable sources of energy. The cost-efficient utilisation of natural cooling sources is one of the key advantages of concrete core activation technology. Thanks to the storage capacity of such systems, it is possible to use the energy stored overnight during the daytime when the building is in use. The combination of Uponor Contec operated during the night with Uponor Contec ON to cover peak loads, is a highly effective solution for just-in-time climate control during the daytime.

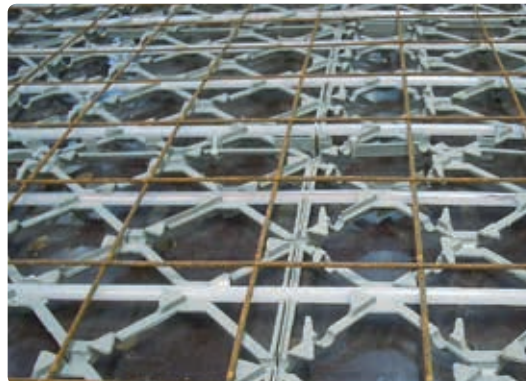

Contec ON standard version installed close to the ceiling surface on the formwork

6.4 System components

Uponor PE-Xa pipes

The PE-Xa pipe has an oxygen diffusion barrier manufactured from peroxide cross-linked polyethylene (PE-Xa) using the Engel method and in compliance with EN ISO 15875: "Plastics piping systems for hot and cold water installations - Cross-linked polyethylene" with an oxygen diffusion barrier of EVOH (ethyl vinyl alcohol).

Uponor pipes fulfil the requirements for oxygen diffusion resistance as set out in DIN 4726. Design pressure is 6 bar.



Uponor Contec hook

The specially designed hook ensures fixture of the module in the statically neutral zone of the ceiling and prevents the module from floating on the poured-in concrete. Each Contec module is secured with four hooks per m² at the desired height.



The Uponor mesh hook method of fixture allows for exact vertical positioning and attachment of the pipe mesh to the overlaying reinforcing steel structure.

Calculation of the pipe position at the centre of the ceiling

$$H = \left(\frac{D_{De}}{2} + \frac{D_{Ro}}{2} + 7 \right) - s_u$$

$D_{De/2}$ = ½ ceiling thickness
 D_{Ro} = pipe diameter, e.g. 20 mm
 H = mesh hook length
 s_u = concrete layer above top reinforcement, e.g. 40 mm

Example:

Ceiling thickness = 190 mm
 Pipe diameter = 20 mm
 Concrete layer = 40 mm
 H = 72 mm
 Chosen mesh hook length:
 H = 70 mm

$$H = \left(\frac{190}{2} + \frac{20}{2} + 7 \right) - 40$$

Thickness of concrete ceiling B (mm)	430 – 460	360 – 340	340 – 320	320 – 300	290 – 260	250 – 230	220 – 200	190 – 170
Mesh hook H (mm)	180	150	140	135	115	100	85	70

To cater for various ceiling thicknesses, the mesh hooks are available in a range of lengths from 70 mm to 780 mm

Uponor cable tie

This is used for fastening Uponor pipes on the steel mesh. It is made of polyamide.

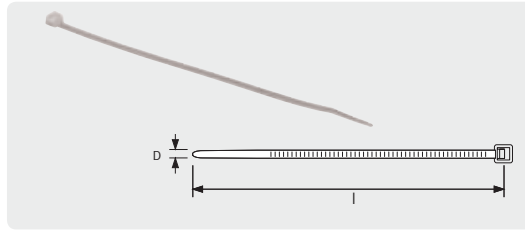

Uponor Contec ceiling pipe lead-through

The patented ceiling lead-through element from Uponor allows the cooling or heating pipes to be led from the concrete ceiling into the room below without causing damage to the formwork. This is a necessary prerequisite for rented formwork, which is the most widely used solution today. The heating or cooling circuits can be pressure tested at any time, before, during or after concreting.

Uponor lead-through elements offer another important advantage: using this method, connecting lines of any lengths can be pulled from the ceiling for direct, adapter-free connection to other lines, including manifold collection lines.

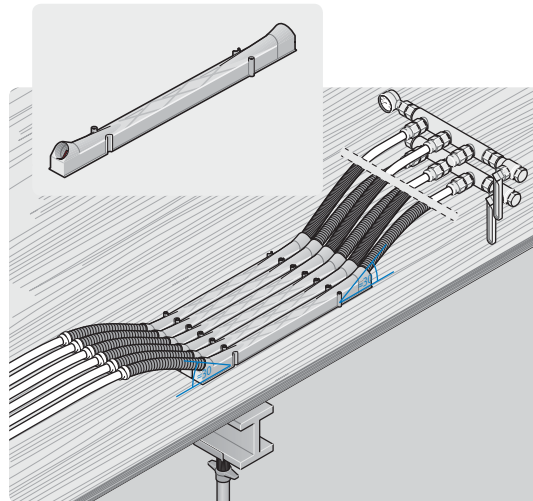

Ceiling leadthrough elements positioned on formwork and pressure testing of Contec connecting lines

Principle

The connecting line extending from one side of the module is threaded through the ceiling lead-through element, which is nailed to the formwork. Special red tabs in the ceiling lead-through element enable the installer to determine the direction of the pipe lead-through, which is necessary for the later removal of the connecting line. The protective pipe at this side of the

element prevents concrete from entering the pipe system. On the other side, the connecting line remains enclosed in a protective pipe, and protrudes above the upper edge of the concrete layer, so that this end of the line remains flexible and can be pulled back into the floor when necessary.

Dimensions:

- Length: 540 mm
- Width: 39 mm
- Height: 29 mm

Max. height: 57 mm (at connection point)

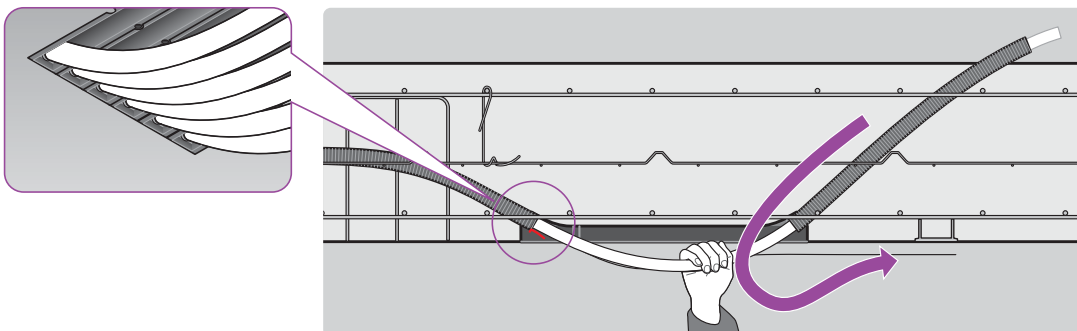

Pipe flow direction is marked with a red tab in the ceiling leadthrough element

Uponor protective pipe

If the modules or the cooling/ heating circuits are to be connected to a manifold/collection line installed in a double floor, the Uponor protective pipe is the ideal solution for the installation of the connecting line upwards out of the bare concrete floor. This protects the Uponor PE-Xa pipe where it exits the concrete. As the protective pipe is flexible, the connecting line can be attached in a horizontal position even in a very confined space.

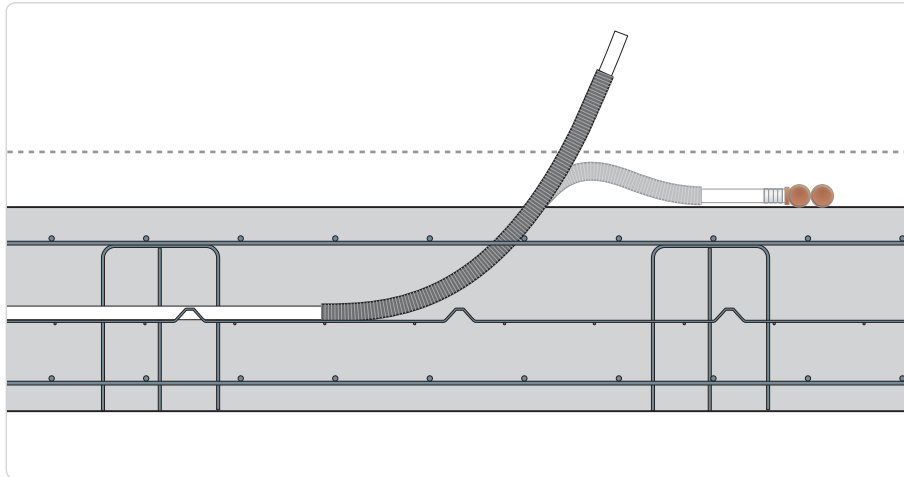

Options for manifold installation: directly on the floor structure

Uponor fix bend support plastic

If the modules or the cooling/ heating circuits are to be connected to a manifold located above the activated floor, the Uponor fix bend support should be used to deflect the pipe by 90°.



6.5 System accessories

Uponor Contec TS Thermal Socket



Highlights

- Optional provision of additional thermal energy
- Flexibility for subsequent change of room use/planning
- Postponed commissioning without the need to drain the system

Recommended for:

Add-on to Uponor Contec, where there might be increased need for cooling in certain sections of the building

Uponor Contec TS extends the concrete core activation system by providing a thermal socket that allows for the connection of additional, external cooling/heating or peak load elements that can be freely suspended from the ceiling.

To connect the thermal socket outside the concrete ceiling, an adapter plug is required (accessory available from Uponor). The Uponor Contec TS socket is mounted directly on the ceiling formwork and is then embedded in concrete

together with the distribution lines. The system features an automatic shut-off device so that the socket can be commissioned with the adapter at any time without the need to drain the lines.

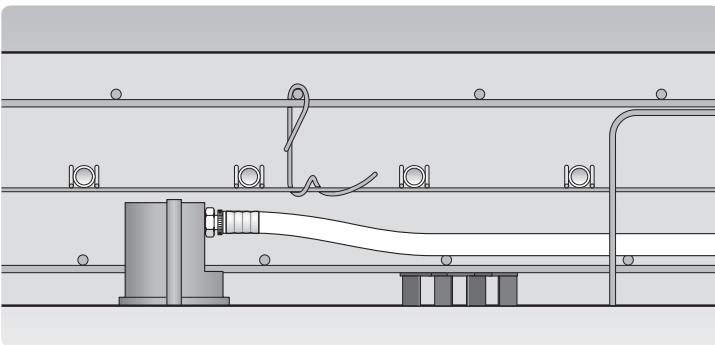

Installed Uponor Contec TS socket – sectional drawing

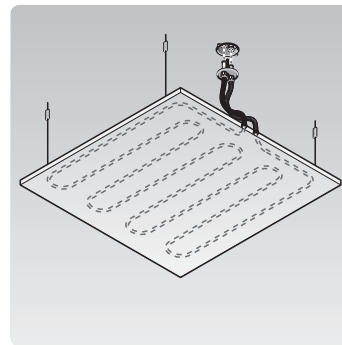

Bottom view: Separate peak load element with Contec TS connecting adapter



Bottom view of embedded socket



Bottom view, mounting plate removed



Bottom view, connecting adapter fitted

Uponor Contec TS



Optional cooling/heating capacity



Approx. 200 kg/h or 850 W/unit at 4 K systems spread

Pressure loss: thermal socket

Normally, the lengths of circuits for concrete core activation are chosen based on a pressure drop of max. 350 mbar. To have sufficient reserve for pressure drops occurring in connecting lines for thermal sockets and the connected radiant ceiling panels, the volumetric flow rate should be between 0.15 and 0.16 m³/h to prevent a pressure drop inside the socket of more than approx. 150 mbar.

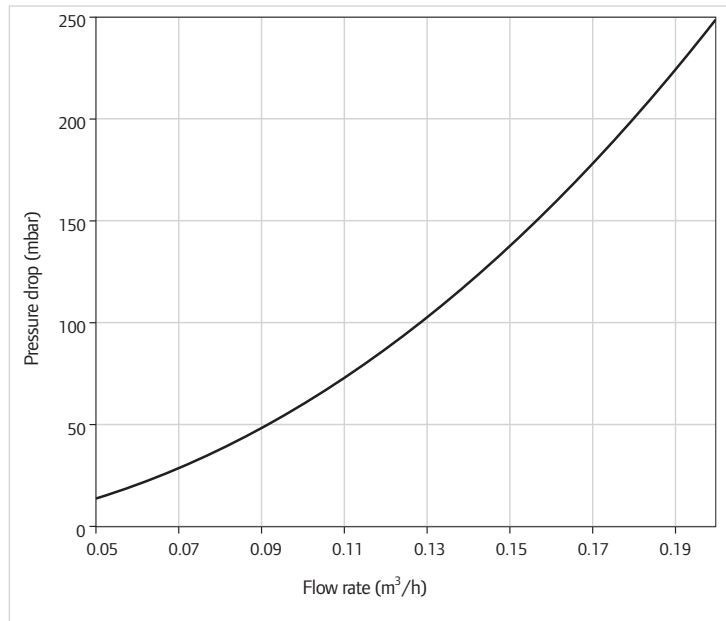

Hydraulic integration

Thermal sockets can be connected to the system in several different ways. If only minimal additional output is required and the sockets can be operated together with the

concrete core activation, they are connected to the same supply line (two-pipe system) as the concrete core activation. Usually, the required additional output is however greater, or the socket is to be operated at times when concrete

core activation is not in use. In this case, the sockets should be equipped with at least a separate supply line and shared return line (three-pipe system). Alternatively, the sockets can be operated through a completely separate circuit (four-pipe system).

Two-pipe system

In two-pipe systems, the thermal sockets and Contec modules share a supply and return line. This is a cost-efficient solution, as it requires less material and labour. This type of circuit is however only suitable for buildings where the sockets and the modules are to be operated at the same time and with the same system temperature.

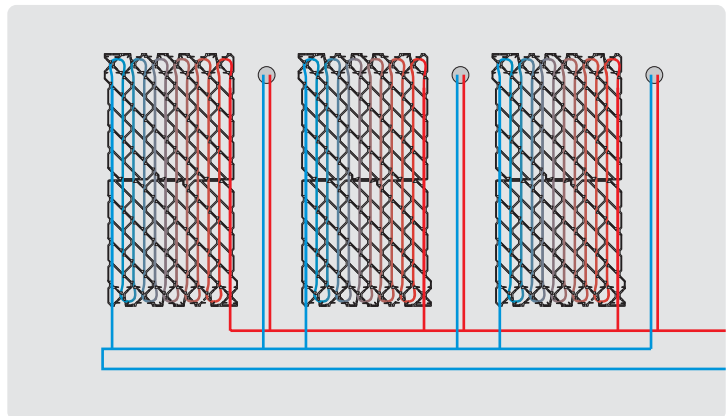

Three-pipe system

In three-pipe systems, the thermal sockets and the Contec modules are supplied with cooling/heating energy through separate supply lines but share a return line. This type of system is particularly suitable for installations where the socket and the heating/cooling registers are to be operated at different times. The components, however, remain hydraulically linked.

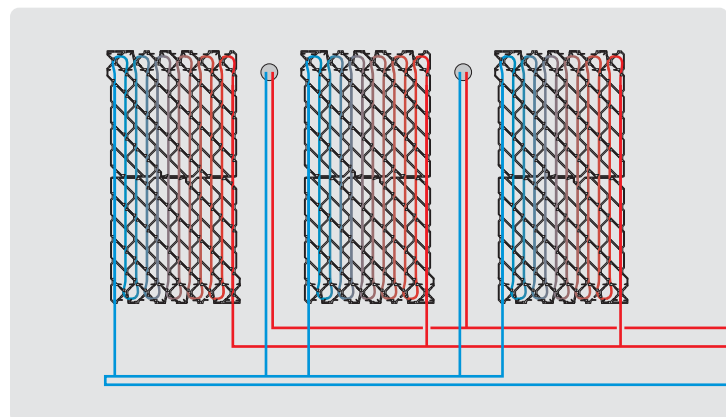

Four-pipe system

In four-pipe systems, the circuits for the thermal socket and the Contec modules are fully separated from each other. This system is the most expensive, as it requires more material and additional labour. It has however the advantage that the thermal socket and the Contec modules can be regulated and operated independently from each other.

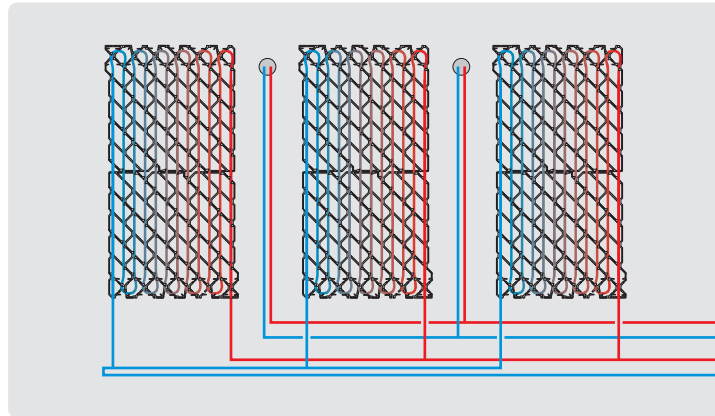

Uponor Velum

Uponor velum heating and cooling ceiling panels combine high cooling capacity with draught-free comfort. They absorb sound and reflect diffused light onto the work area. Their elegant, compact design meets high architectural standards and fits perfectly into the modern office environment.

By means of the Uponor Contec thermal socket, Uponor velum panels are ideal for use in combination with Contec Systems in buildings with cooling peak loads. Due to the sound absorbing elements integrated into the panels, they help improve acoustic comfort in the rooms where they are installed.



Technical characteristics	
Sizes	1200x600 / 1200x800 / 1600x800
Cassette	Perforated galvanized sheet steel
Suspension structure	Free hanging
Color	White RAL 9010
Heat conduction profile	Extruded aluminum
Pipe	Copper pipe 12 mm
Fittings	Flexible hose
Sound absorption according to DIN EN ISO 354	Alpha_w approx. 0.8
Cooling capacity according to EN 14240 (8K)	Approx. 100 W/m ²
Heating capacity according to EN 14037 (15K)	Approx. 150 W/m ²

Advantages

- Extremely flat design
- High cooling capacity
- Excellent room acoustics through integrated, sound absorbing elements
- Perfect for all room comfort requirements of Contec and canopy system

Control and operation

7.1 Basics

In principle, TABS, i.e. the utilisation of thermally-activated building structure to achieve better uniformity of room temperature, only requires simple controls. The main difference to conventional heating and cooling systems is the utilisation of the large thermal mass of the building to store energy and thus exchange heat. The latter makes it possible to use a much lower temperature for heating and a much higher one for cooling.

In the case of mean water temperatures (20–24°C) that are in the range of target room temperatures (22–24°C), the system almost

controls itself. This self-regulating effect can be explained by the following example: a permanent supply temperature of 22°C allows for huge thermal mass storage. If room temperature exceeds this value, the concrete mass extracts heat from the room. If room temperature falls below the temperature setpoint of 22°C, heat will be transferred to the room.

Unfortunately, this effect is often not sufficient for a load-optimised and more energy-efficient temperature controlled building. Due to the low temperature differences between the surface of the activat-

ed mass and the room, only limited amounts of heat are exchanged. The pumps operate permanently and this continuously consumes energy.

In summary, some form of control is required for the following reasons:

- Increase in performance through lower or higher water temperatures
- Ability to avoid the condensation caused by lower water temperatures
- Modification of operating sequences, mainly for energy saving reasons

7.1.1 Operation modes

The operation mode of TABS depends on the chosen control strategy. It defines the timing and length of TABS loading and

unloading, and thus the operation of the pump. However, the overall control system should also offer scope to modify the water

temperature and/or water quantity (mass flow). This will be discussed in the following chapter.

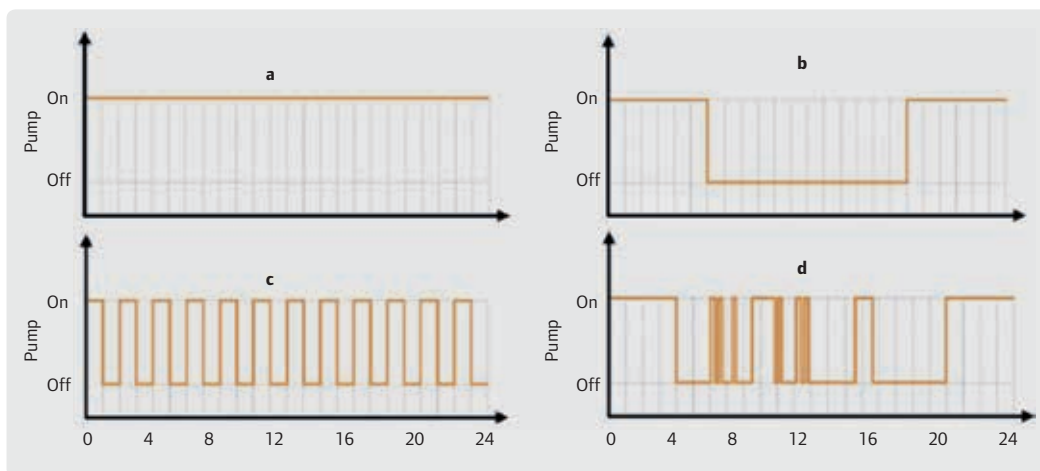

Different modes of operation for TABS

- a) Continuous operation of pump
- b) Day-night operation
- c) Continuous intermittent operation of pump
- d) Discontinuous intermittent operation of pump

Controlling the hours of operation

One advantage of TABS is that in many cases active cooling is only required for part of the day. It may be advantageous to operate the Uponor Contec system only outside hours of building occupation. In this

case, it may be possible to utilise a cheaper night-time electricity rate for the cooling compressors or free cooling due to lower night-time temperatures. Furthermore, if additional cooling via the air condition-

ing system is used, the chiller does not have to be designed for total system capacity (concrete core activation + air conditioning system), but only for reduced peak demand.

The diagram below shows the results of a simulation with 24-hour system availability for operation, compared to reduced system availability for operation

between 6pm and 6am or 10pm to 6am. With shorter operating times, room temperatures are only slightly higher, but pump energy savings are significant.

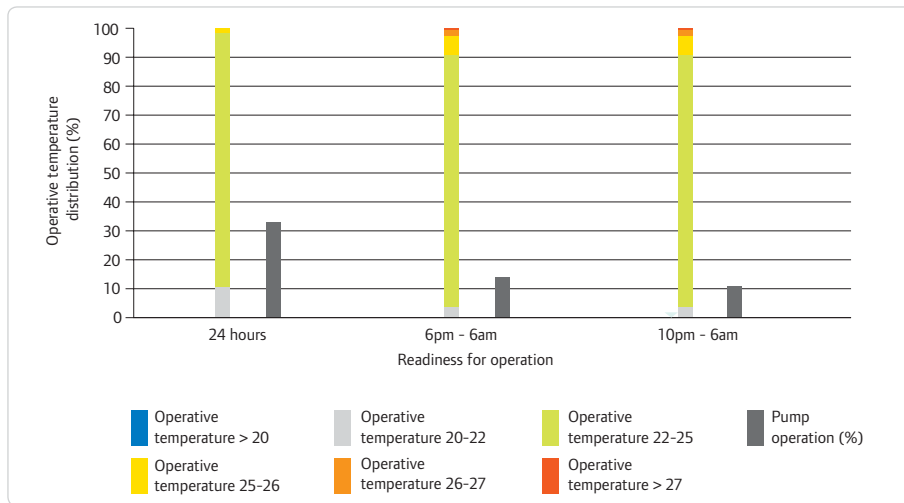

May to September – mean water temperature control based on external temperature

Intermittent operation

Studies show that it is possible to run the circulation pumps intermittently (switched off for 45 min. or 30 min. every hour) without significant reduction in overall output. Based on dynamic simulations, the fol-

lowing table shows that room temperature frequency distribution for specified temperature intervals is almost identical in all four cases, although pump energy consumption is much lower if pumps are run intermittently.

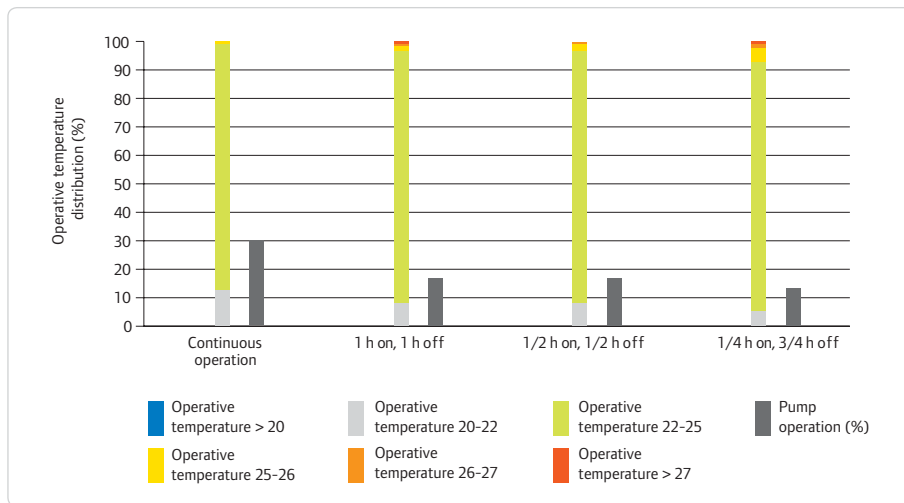

May to September – control of flow temperature depending on dew point temperature based on 24 h readiness for operation

In these studies, the system was in operation for 24 hours, and in all cases the supply temperature was controlled based on dew point. For shorter operating times (during the night) and higher water temperatures, intermittent pump operation may be unable to provide the desired cooling output. Depending on the floor structure, output is practically identical if the water flow is stopped for 30 min. or 45 min. per hour. While the pump is off, heat stored in the concrete will continue to flow to the cooler regions around the pipes. Once the water flow is switched on again, cooling output will

increase temporarily due to the higher temperature difference between the water and the concrete. However, due to the inertia of the system, such fluctuations in output have no effect on the relevant surfaces. Cooling output therefore remains unchanged, and the disruptions in heat dissipation have practically no influence on room temperature. In order to make the flow temperature as high as possible, the Uponor Contec system is designed for a small temperature difference (approx. 4 K). For very small temperature differences (< 1 to 2 K), water quantities can be reduced or the pumps stopped.

7.1.2 Operating temperature

Controlling the water temperature

According to the diagram below, controlling the mean water temperature is the most preferable option.

If the mean water temperature (average between supply and return temperature) is used as the control parameter, higher cooling loads (solar radiation, occupants) and therefore higher return temperature, lead to an “automatic” decrease in flow temperature in order to keep the mean water temperature constant. If, however, the supply temperature is used as control parameter, mean water temperature will rise, leading to reduced output. The target value of mean water temperature could be set to a constant value depending on the season (winter/summer). It is also possible to use the external temperature as control parameter based on a heating/cool-

ing curve. In this case, the slope of the heating/cooling curve is very slight. Room temperature may also be included in the control algorithm.

The following diagram shows the results of a simulation with system availability for operation between 6pm and 6am. Control of supply temperature based on external temperature leads to almost the same room temperature frequency distribution as control based on the mean water temperature, although pump energy consumption is much higher. For the simulated case (an office building in Germany) a constant mean water temperature of 18 °C regularly leads to the room becoming too cool, while at 22 °C the room tends to overheat. Control based on external temperature therefore improves comfort.

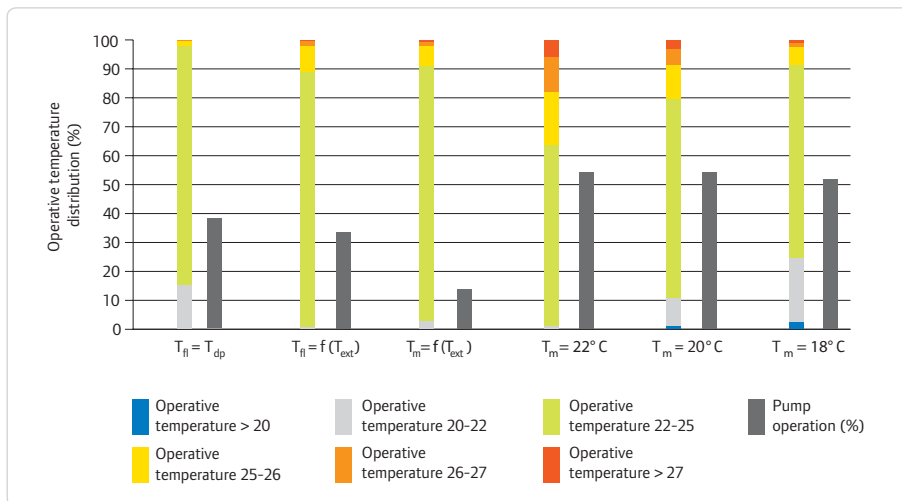

May to September – different control strategies based on readiness for operation between 6 pm and 6 am

7.1.3 TABS zoning

Generally, single room control with TABS does not make sense. Adequate zoning, however, does make sense. In many cases, it is useful and necessary to split the building into different TABS zones for optimal TABS control. Attention needs to be paid to the internal and external loads in the rooms: if the difference is too great, a split into zones is recommended. The following parameters are particularly important:

External loads:

- Orientation of the room (south, east, west, north)
- Window area per orientation
- Location of the room (corner room or internal space)
- Shading from solar radiation by other buildings or trees
- Different thermal insulation of walls

Internal loads:

- Thermal mass in a room: room furnishing, shelves, tables, etc.
- Different wall constructions (lightweight, solid construction)
- Room occupancy: number of people in a room and duration of stay
- Electrical equipment such as computers, lamps, printers, etc.
- Different comfort requirements: in case there are offices and PC server rooms in the same building with different comfort requirements, a separate zone for each should be provided

Zoning should not only take into account differences in solar radiation (north-south, east-west), but also differences in internal loads (occupants, lighting, equipment) and transmission losses in winter (corner rooms). In general, there should be scope for optimising or modifying the control parameters after commissioning and during daily operation.

Important design advice:

- The control software must offer scope for modification and optimisation. All parameters as well as time and temperature intervals should therefore be available as user inputs, rather than programmed as fixed values
- Note that individual TABS room control does not generally make sense. However, for groups of spaces with different cooling loads (solar radiation, orientation, internal loads), zoning is well worth considering. Different zones can thus be controlled independently.

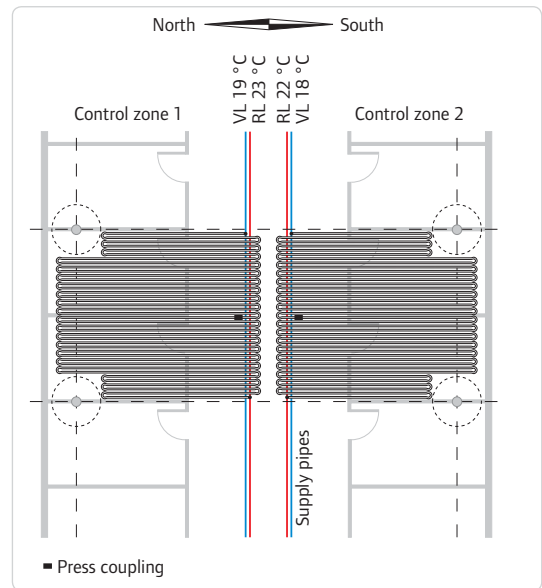

Module installation with control zones (indicated for Southern hemisphere)

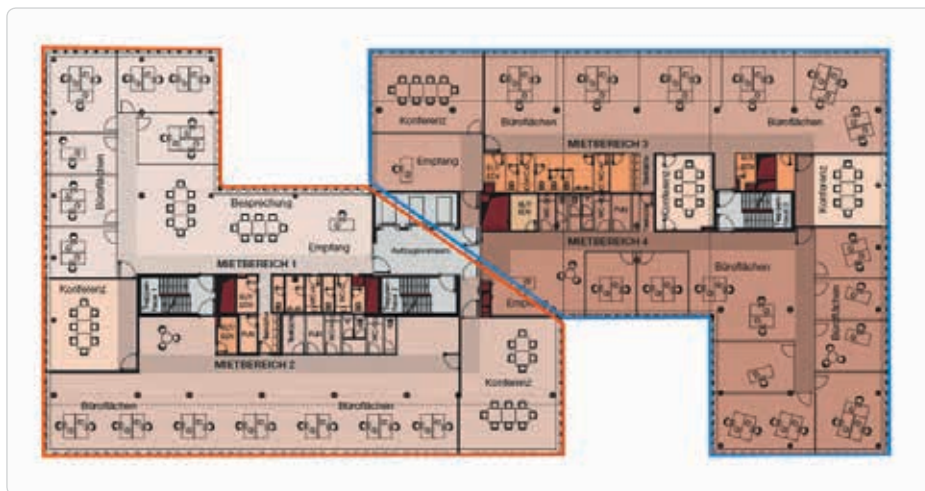

The above illustrative ground plan of a TABS equipped office building in Hamburg, demonstrates that the zoning of a building depends on the actual geometry of the building, its orientation, the use of its different areas and the related internal and external loads.

7.1.4 TABS hydraulics

There are numerous ways to construct the hydraulics for TABS. The most common hydraulic variants can be classified in three categories:

- Variant with two distribution lines
- Variant with three distribution lines
- Variant with four distribution lines

The choice and the correct design of the hydraulics is very important for proper function. It is not only necessary to determine how many different conditioned areas there will be in the building, but also how efficient the overall system is and whether only heating or cooling, or both simultaneously but in different zones, can be realized. Thus, for example, zone 1 can be cooled (in the case of high internal loads such as in server rooms) and zone 2 can be heated at the same time (normal office space in winter). Variants with two distribution lines have the disadvantage that they can only be used for either cooling or heating. With three distribution lines hot and cold water can be provided simultaneously. Choosing a system with three distribution lines means that mixing will be inevitable.

In comparison to three distribution lines, four distribution lines have the advantage of a separate return line for hot and cold water. The diagram below shows the three types of hydraulic variants. The zone pump can either be continuously variable, or multi-stage, or used

as a two-stage pump. The control valve in the supply ensures a defined flow temperature. Zone return is mixed with zone supply. A check valve prevents wrong circulation. With four distribution lines there are additional control valves in the zone return so that the return of each zone can be assigned to cold or warm return.

Three or four distribution line systems each have their own advantages and disadvantages. One of the decisive factors to be considered is mixing gains and losses: choosing a system with three distribution lines, means that mixing will be inevitable. Thus, three distribution lines should be chosen when mixing gains are higher than mixing losses. On the other hand, with four distribution lines, gains cannot be utilised, but at least there are no mixing losses. Apart from the mixing gains or losses to be utilised or avoided, investment costs constitute another important factor to be considered when choosing system configuration: a system with four distribution lines incurs higher investment costs.

To summarise: the benefits provided by a three or a four distribution line configuration should be weighed up at the design stage against related investment costs and ideally calculated using supporting simulations.

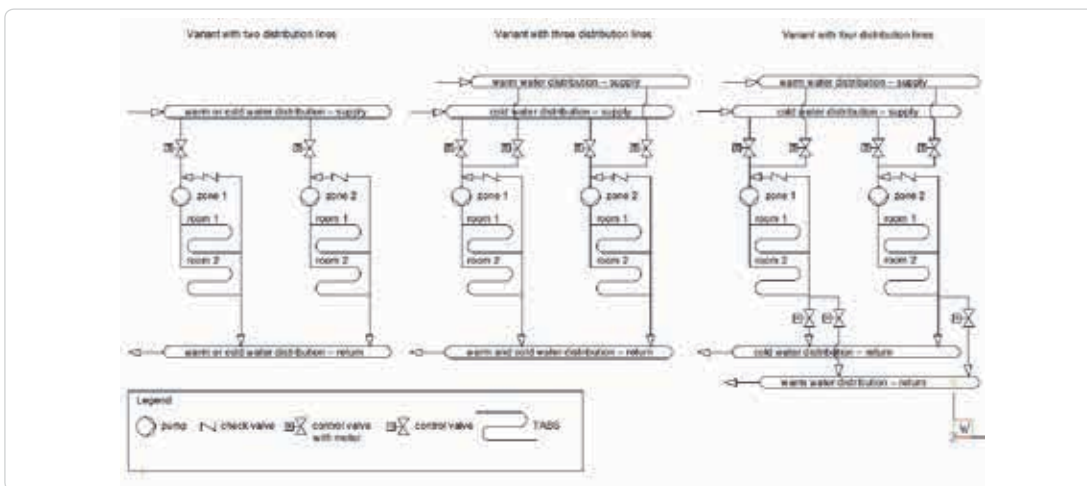

7.1.5 Sensors

For control purposes, the following sensors should be installed (for each zone):

- External temperature sensor
- Supply temperature sensor
- Optional: return temperature sensor
- Optional: room temperature sensor
- Optional: humidity sensor (relative or absolute)

A ceiling or floor temperature sensor may be useful for limiting the respective temperature to a minimum and/or maximum value, or for inclusion in the control algorithm.

3 With a ceiling temperature of 22 °C, the saturation moisture content is 17 g/kg, and the critical external moisture content therefore 14 g/kg. This means that dew point temperature is only exceeded for 22 out of 8.760 hours per year. In meeting rooms with high moisture loads, it may be advisable to install (local) dehumidification devices.

Limiting flow temperature based on dew point temperature via a controller leads to slightly higher water temperatures and therefore also ceiling temperatures during warm and humid days. This prevents the risk of condensation. Furthermore, due to the large absorption capacity of ceilings, walls and furniture etc., humidity in one area of a building will only rise slowly even if external humidity rises rapidly or in the presence of additional internal moisture sources.

General preventive measures to avoid condensation in extremely humid conditions:

- Design of flow (surface) temperature (HX diagram)
 - Limitation min./max. value
 - Limitation dew point (temperature with certain offset)
- AC humidity control
 - Dehumidification, air renewal
- Airtightness of the building/infiltration
 - Avoid uncontrolled penetration of humid air
 - Displacement diffusers or air curtains in areas adjacent to the entrance, providing cool dehumidified air to generate air stratification
 - “No man’s land” in areas adjacent to entrances
 - During cooling season: control sequences to close all related control valves on those loops close to entrances
 - Revolving doors in commonly used entrances of large areas
 - Supporting ventilation/dehumidification air system, providing uniform distribution of air around conditioned areas
 - Building envelope insulation and seal around glass panes/windows

- In many applications, surface heating/cooling systems are combined with a mechanical ventilation system.
- The air may be dehumidified via a ventilation system in order to prevent condensation and increase output. The humidity sensors may be installed in the exhaust duct.
- Water features that enable lower water temperature, decreasing the evaporation rate from the water and acting as dumper for area moisture ratio increase.
- Control sequences:
 - Increased air flow with increased occupancy
 - Supply air temperature reduced with increased dew point temp.
 - Surface circulation pump shutdown control
 - Dew point control during non-occupancy period and/or morning dehumidification circle

Example: The following graph shows the safety margin between surface temperature and dew point for an open office in Madrid (small air condition applied with uncontrolled dehumidification for 10 % of peak hours), for a summer week. It clearly shows that there is no danger of condensation with TABS, not even on the most extreme days.

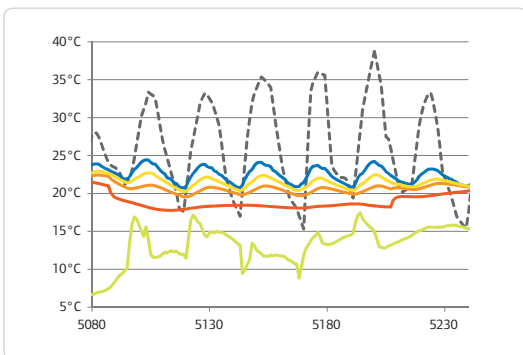

Safety margin between surface temperature and dew point

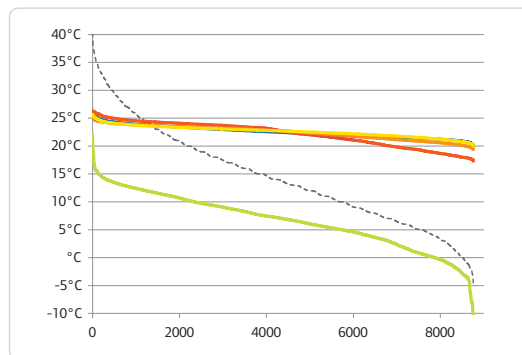

The whole-year profile provides proof of condensation free operation

- External temperature
- Operative temperature
- TABS/Z1 supply
- TABS/Z1 return
- Ceiling temperature
- Dew point temperature

7.2 Combination with additional secondary systems

Secondary systems are often used in combination with TABS. Section 7.1 explains how TABS is combined with an additional conventional HVAC system to ensure that no condensation occurs. Additionally, TABS can be combined with any other heating and/or cooling system to provide additional heating/cooling capacity if this is required by prevailing conditions.

TABS can, for example, be combined with radiators to cover higher heating demand. In other cases, TABS can be coupled with close-to-surface radiant heating/cooling areas integrated into the construction of the building, and/or into suspended heating/cooling panels in order to deliver a higher heating and cooling output.

These panels can also provide acoustic and lighting services, as they can be equipped with integrated sound absorption material and lighting elements.

Any other conventional air based HVAC system can accompany TABS to provide hygienic air change rates and the desired higher demand. Typically, there will be a split between the TABS function, which serves as base load, and the additional air or radiant system, which is able to cover peak load due to a faster reaction mode. Deployment of this additional system, will achieve room temperature control.

The two diagrams below show heat exchange and flow pattern during heating/cooling operation.

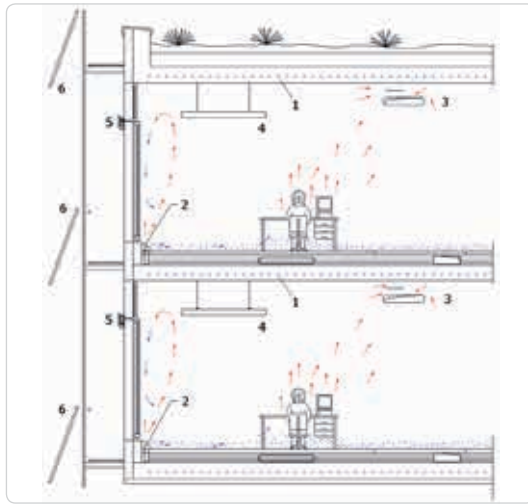

Reference room: winter

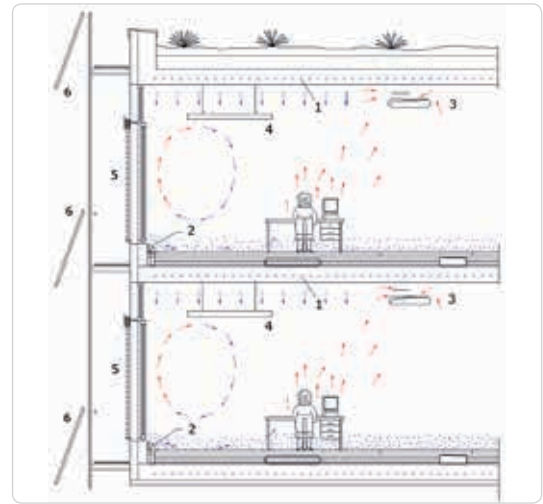

Reference room: summer

- 1= thermal active slab
- 2= fresh air supply with local heating
- 3= air exhaust above
- 4= lightning
- 5= shading
- 6= photovoltaic

7.3 Different conventional TABS control strategies

In this section, the most common control strategies in a large number of buildings with TABS are presented. The different strategies are explained in general terms. The list provides an overview but is not complete, as this goes beyond the scope of this section.

Three-stage control according to room temperature

A three-stage on/off control (three-point control) is applied to control the TABS. For cooling, the pump switches on when the desired set point is exceeded, and as soon as the temperature is in the com-

fortable range, it switches off again. The supply temperature of the corresponding TABS is always the maximum possible temperature. In cooling mode this is a supply temperature of approx. 17°C and in heating mode a temperature of approx. 29°C. The controlled temperature is room temperature. A hysteresis range to avoid constant on and off of the system is also typically taken into consideration, as shown in the following graph:

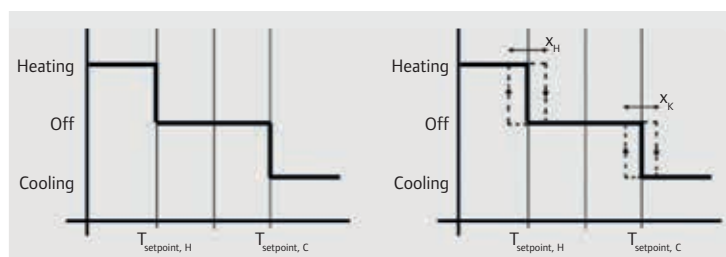

Supply temperature control as a function of external temperature

There are different variants of this control strategy. However, the supply temperature of TABS is always a function of the measured external temperature. It is recommended for buildings with both heating and cooling needs, as well as in office buildings for working and non-working days (internal loads differ extensively on these days) where different characteristic curves need to be defined. These characteristic curves can be adapted to the building in advance through appropriate design tools or dynamic simulation programs. At a later stage, during operation, the characteristic curves should be adapted and optimised on the basis of experiential data.

The two main variants of this control strategy are:

1. Supply temperature is controlled based on the current outside air temperature
2. Supply temperature is a function of the average outside air temperature of the last 24 hours

In principle, the sliding average of outdoor air temperatures or mean values from different time periods as a function of supply temperature can also be used. When the outdoor temperature is in the neutral zone neither cooling nor heating is required.

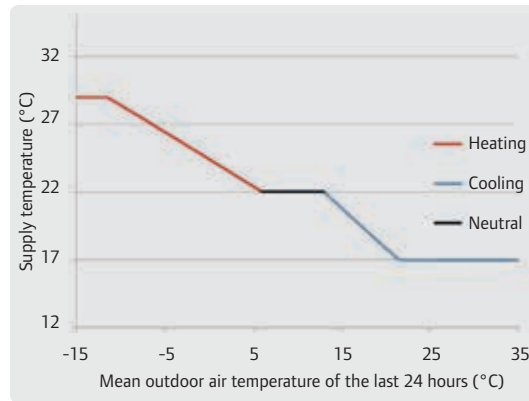

Supply temperature characteristic as a function of the mean outdoor air temperature of the last 24 hours

Return temperature control

Based on the recorded return temperature, the actual energy requirements of a zone can be defined. Thus, disturbances such as solar radiation and internal loads of a zone can be considered. Again, characteristic curves are created depending on the outside temperature for control of the return temperature. The variants are comparable with those of supply temperature control.

Difference between supply and return temperature

In this control strategy, the difference between TABS supply and TABS return temperature is considered as a control parameter. The larger the difference between supply and return temperature, the higher the power output with respect to the power consumption of TABS. If a previously defined smaller difference is reached, the circulation pump will be switched off. When the flow in a zone is interrupted, no statement can be made regarding return temperature. Therefore, it must be ensured that water circulation takes place at regular intervals (flushing). If pump speed is controlled, volume flow can be greatly reduced when the difference between supply and return is below the limit. The measurement of real return temperature is possible without the need to pulse the pump.

Pulse-width modulation

The pulse-width modulation can be assigned to the operating mode of intermittent operation. It is an

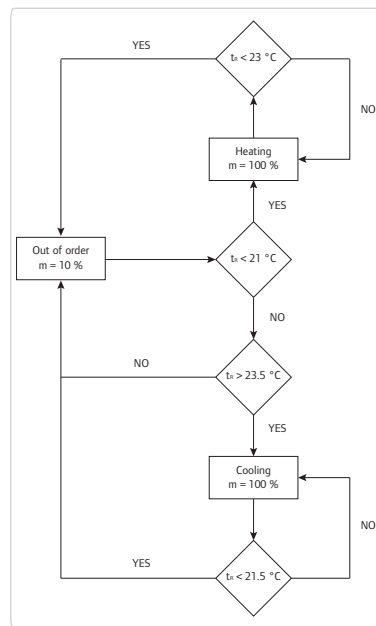

Return temperature control

additional strategy to those control strategies already described and can therefore not be used without one of the aforementioned strategies.

The objective of pulse-width modulation is to reduce the electrical auxiliary power-energy of the pump or compensate for different zone loads. This is achieved as follows: the temperature difference between water temperature and the temperature of the thermally activated slab is increased by "off phases", and thus in less time a higher amount of power can be transferred in comparison to continuous operation of the pumps.

7.4 Predictive TABS control

This section examines the predictive control of TABS. Typical predictable values that can be used in the control algorithms are: data from weather forecasts (temperature, radiation, humidity, rainfall, etc.) and occupancy plans of rooms and load forecasting of electrical equipment.

7.4.1 Concept

The time needed to identify temperature change at the heat exchange surface, from the moment that water supply temperature has changed or from the moment that mass flow has stopped, is a few hours. Due to the very long reaction time, control with the conventional P or PI controller is limited. Reaction time as a result of suddenly occurring disturbances (rapidly changing internal loads) is relatively high. Nevertheless, even though a rapid change of room temperature cannot be expected

due to the loaded storing mass acting against it, an early pro-active reaction to sudden loads is desirable. If a reliable forecast is available, it is advantageous to act in advance so that limited temperature fluctuations appear. This ensures that a comfortable temperature zone is secured at all times. Additionally, energy savings can be achieved due to improved management of storage mass loading and unloading. Predictive TABS control implements exactly this. On the basis of weather forecasts, the main external parameters, such as solar radiation and ambient temperature, can be recognized in advance and incorporated in the internal loads calculation to deliver heating or cooling capacity according to actual demands.

The advantages of predictive control can be clearly identified when compared with conventional control strategies which take into account current or past data:

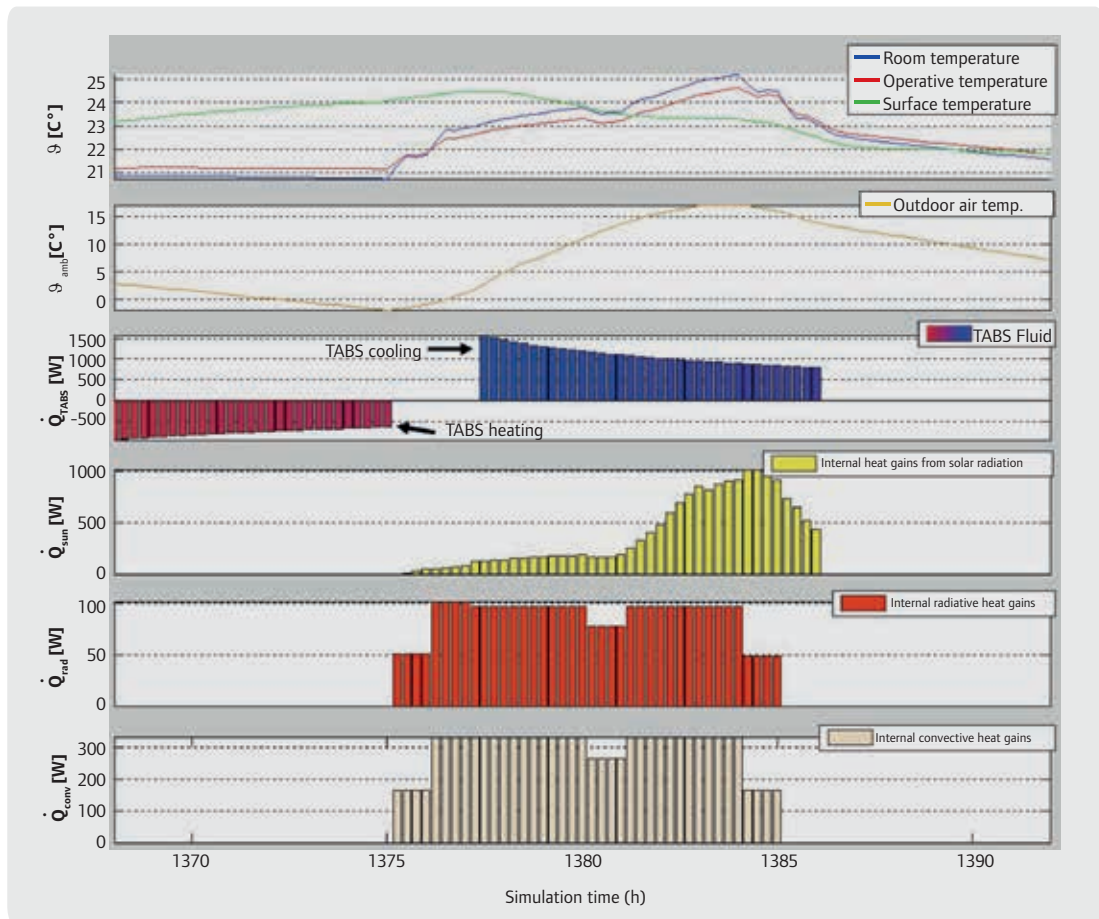

The diagram illustrates variations in room, operating and surface temperature by three-stage control, taking into consideration internal and external loads

Based on the conventional strategy of the three-stage controller, as illustrated in the above diagram, typical problems arising in TABS control are shown.

This example shows why a forward-looking, predictive mode of TABS is useful. By night the room temperature

drops to such an extent that it is below 21 °C and thus the TABS zone is heated. This thermal mass stores heat energy and acts as a reservoir, continuing to heat up the area even at later times when it is already being heated by internal radiative and convective heat. As a result, room temperature increases to above 23 °C and cooling

is switched on. This series of events shows that within a day, an area is both heated and cooled down. Internal loads, extreme changes in outside temperature (from below 0°C to about 15°C) and solar radiation gains cannot be taken into account. This leads to unnecessarily high power consumption. Proper design would eliminate the unnecessary power consumption of heating and cooling caused by external factors.

7.4.2 Supply temperature control depending on predicted outside temperature

The easiest way to achieve this is to extend flow temperature control as previously presented. Rather than controlling supply temperature as a function of the mean outside temperature of the last 24 hours, the average predicted external temperature of the next 24 hours is used to determine flow temperature.

7.4.3 Multiple linear regression

Multiple linear regression belongs to the group of regression analyses. In contrast with linear regression, multiple linear regression has several independent variables. In the case of predictive TABS control these

variables represent the main external effects (e.g. sun radiation, external temperature). The building model and the related optimisation procedure are summarised in this regression.

The method shown here was developed by the University of Offenburg. The process was not only examined through simulation but also in practice. The following section is based on practical experience with predictive TABS control.

For the regression, the average predicted external temperature and the average predicted sun radiation are used as independent variables to calculate the dependent energy requirements for a room temperature of 22°C. The unknown coefficients of the regression plane are determined using historical ambient temperature, radiation and energy consumption data. These are adaptable for changes in internal loads or office occupancy times.

The graph below shows an example of a regression plane to predict the daily energy demand for a room temperature of 22°C dependent on the mean outside temperature and the mean global radiation for the next day.

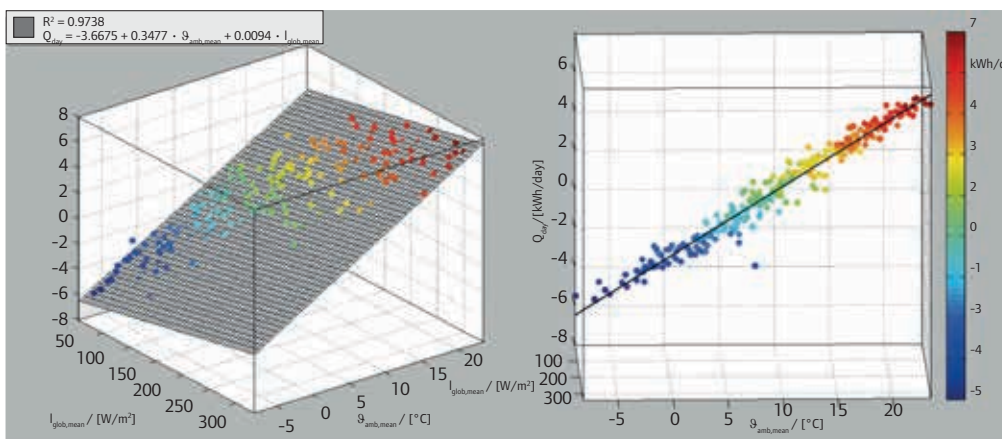

Example of a regression plane

As part of the project “Building services - simulation-based control for sustainable conditioning of buildings”, the new building of company Elektror Airsystems, in which TABS was integrated into the ceiling of each floor, was examined.



Office tower, the new building of Elektror Airsystems and segmentation of the 5th floor

TABS was first operated here with a conventional control strategy. Using the average value of the external temperature of the last 24 hours, operation was determined (heating, cooling, or off). The supply temperature of TABS was based on the current outside temperature, determined in accordance with the figure below. The heating and cooling curves had to be adjusted in practice for over a year by trained personnel, in order to achieve thermal comfort in the building and to satisfy the users of the building.

In the case of extreme temperatures in summer and winter, this process can take even longer. Moreover, in this building frequent corrections for control of the conventional mode of operation had to be performed. The pump was operated at constant speed in continuous operation. This meant that even at low differences between supply and return temperature, electric pump energy was required, but almost no heat or cold was transferred to the room.

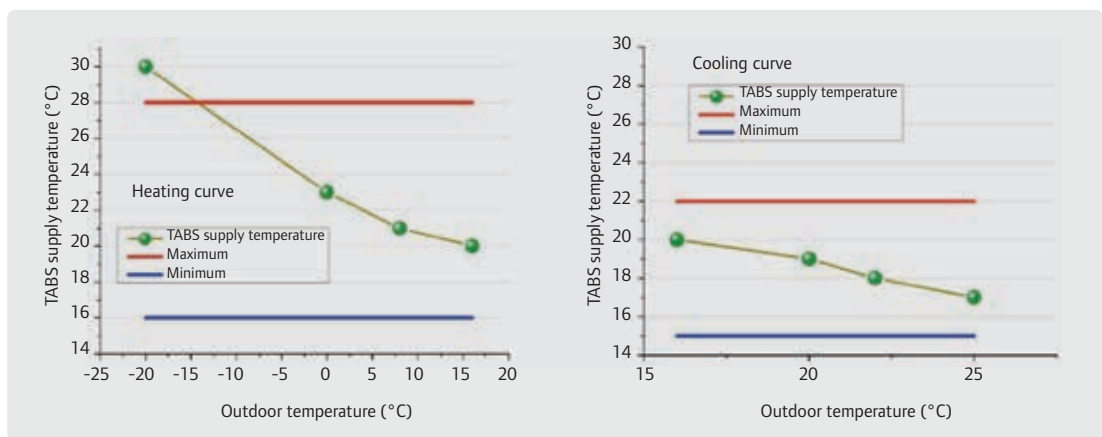

The heating and cooling curve of TABS control during conventional operation in the office building of Elektror Airsystems

By creating an elaborate simulation model of the building and TABS, different control strategies were tested which enabled optimised system operation, taking into account thermal comfort. The previously described algorithm was developed as a result of these investigations. The figure below shows the typical behaviour of the

different control strategies based on the supply and return temperatures. It is clear that much lower temperature differences appear with the conventional control strategy (a maximum of 3.7 K), whereas the predictive mode variation allows a maximum temperature difference of up to 6.6 K.

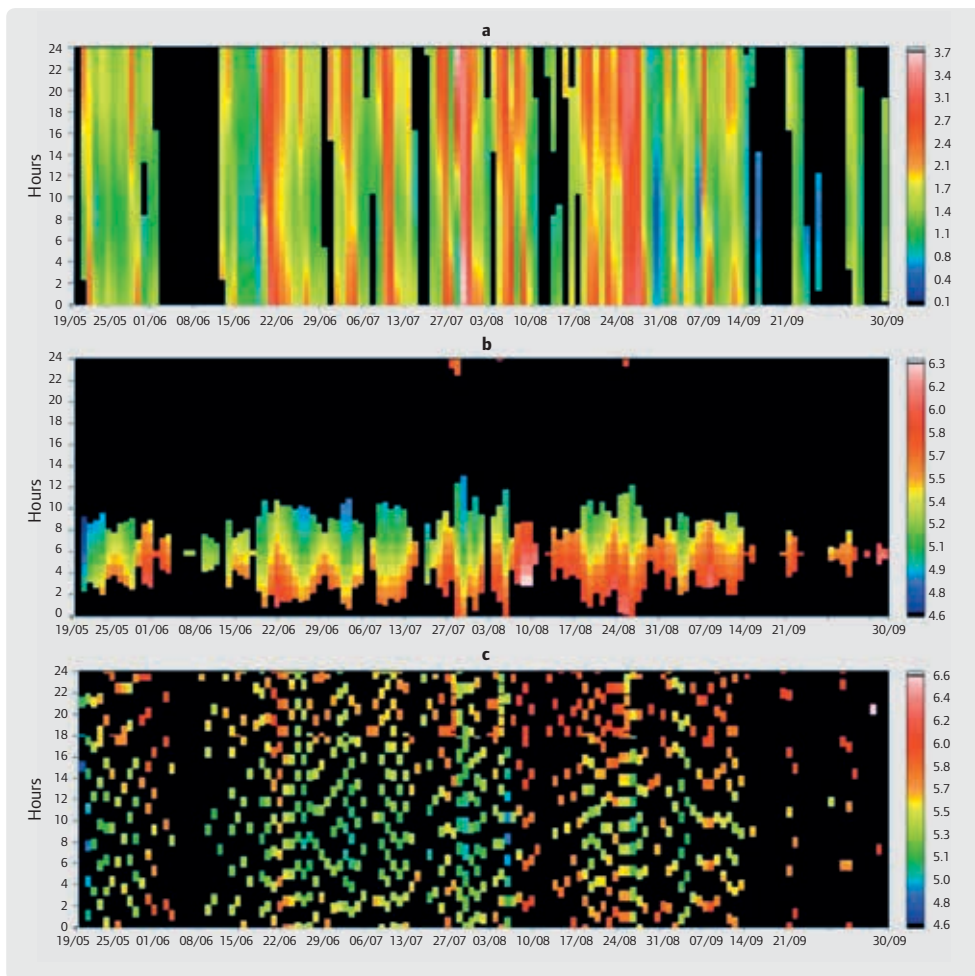

Simulation results of the temperature difference between supply and return with different control strategies: a) conventional control of the supply temperature in the 24-hour mean external temperature, b) predictive night operation, c) predictive mode with pulse-width modulation (scale for temperature differences are different)

Weather forecasts were transmitted to the building automation system through a web service that was developed in cooperation with the company Meteocontrol. Forecast values could be provided for a time period of up to 120 hours. The retrieval of forecasts was performed every 30 minutes for external temperature values and global radiation.

The predictive algorithm was tested for the first time in operation in early July 2009. First the predictive night mode, and then the predictive pulse-width modulation were observed in practical use. From the outset, both modes of operation have proven themselves.

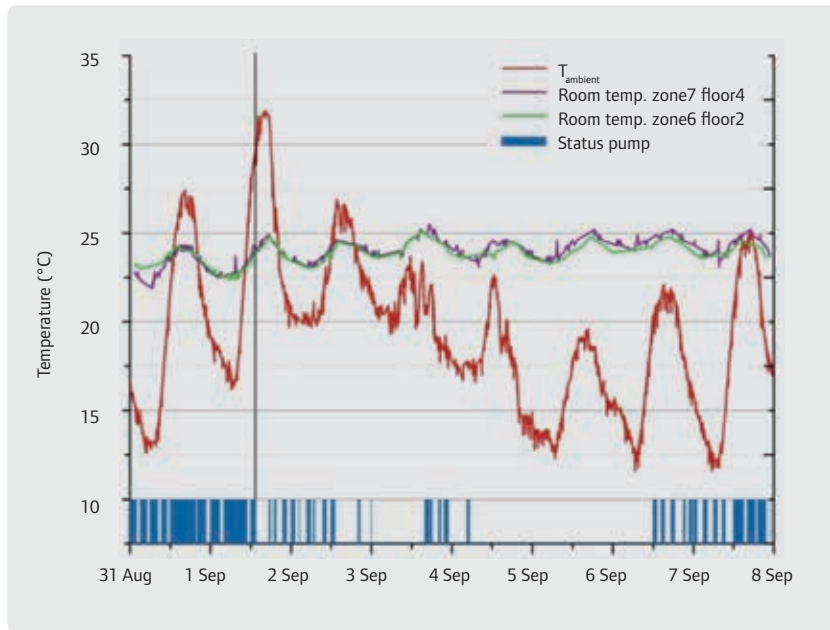

Measurement data of the predictive operation of TABS with pulse-width modulation

The diagram above shows real measurement data using the predictive pulse-width modulation algorithm between the 31st of August and 8th of September 2009. The maximum daily temperatures varied from 32 °C up to 19 °C. Despite the significant changes in weather, the room temperature in the different zones was maintained within a narrow temperature band. The early stop of the pump can be clearly seen at midday on the 1st of September, even though inside and outside

the temperature continued to rise. The algorithm takes into account the storage capacity of the building and can thus save energy.

The simulation results demonstrated by the use of predictive algorithms result in savings of 70 % of electrical pump energy and 7 % of thermal energy, while providing improved thermal comfort in comparison to conventional strategy.

Acoustics

8.1 Basics

In addition to thermal comfort, good acoustics in modern buildings is becoming increasingly important.

The trend in interior design is to move towards optically high-quality, joint-free surfaces made of hard materials such as concrete, glass, ceramic or wood.

These materials increase the demands on room acoustic solutions.

Sound

Sound is the smallest spread of pressure and density fluctuation in an elastic medium like gases, liquids or solids.

In addition to room usage – single office, open-plan office, museum, etc. – the following topics have a significant impact on acceptable room acoustics:

- Sound
- Reverberation time

This chapter does not claim to be an exhaustive acoustics manual, but covers the basics of sound and acoustics at the workplace, and shows solutions for acoustics in combination with TABS.

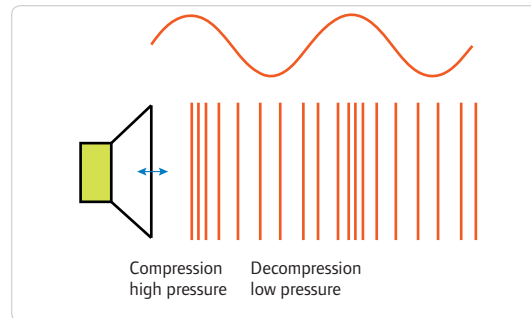

Frequency

In physics and engineering, frequency is a measure of how quickly the repeats follow on from each other in a periodic process.

λ

Wavelength: $\lambda = \frac{c}{f}$

The human ear can "hear" sound waves at frequencies between 20 Hz and 20000 Hz.

Frequency	Wavelength
20 Hz	17.2 m
100 Hz	3.4 m
344 Hz	1.0 m
1 kHz	34 cm
10 kHz	3.4 cm
20 kHz	1.72 cm

Volume

The volume of a sound is a measure of how loud humans perceive the sound. The perceived volume depends not only on the sound amplitude, but surprisingly also on the pitch (frequency).

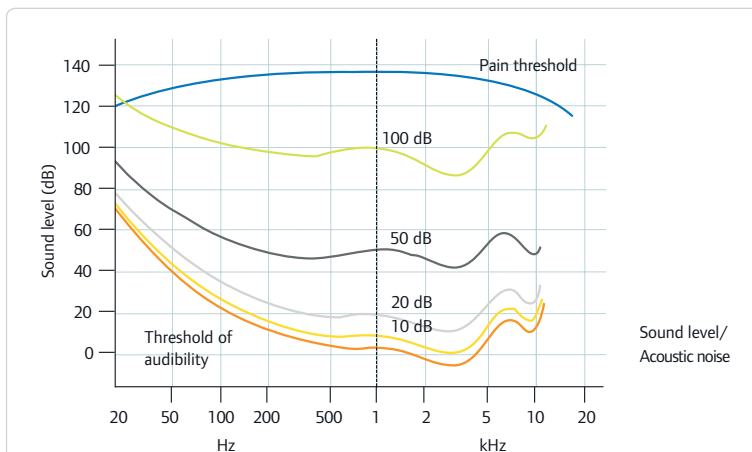

The subjectively perceived volume is measured as the volume level (Lp). The table on the right shows some sound sources.

Reverberation time

The reverberation time is a key factor for good room acoustics. Relevant standards are: DIN EN ISO 3382, DIN EN ISO 11690, DIN 18041, VDI 2569. The definition of reverberation time is the time in which a settled sound signal is decayed by 60 dB.

The reverberation time T, for a diffuse sound field, can be calculated with Sabine's formula as follows:

$$T = 0.163 \cdot V/A = 0.163 / (\alpha_m \cdot S_{ges})$$

V = Room volume

A = Equivalent sound absorbing surface

α_m = Frequency-dependent coefficient

S_{ges} = Active surface

The formula shows, that reverberation time depends on:

- Room volume
- Surfaces of the room
- Sound absorbing objects
- Usage

Depending on type of use and building size, DIN 18041 defines the optimum reverberation time (most comfortable for most people (table 3)). The six octave bands of 125 Hz, 250 Hz, 500 Hz, 1000 Hz, 2000 Hz and 4000 Hz are decisive for this. Reverberation time should remain the same for optimum room acoustics over a frequency range of 100 to 4000 Hz approximately.

Sound source with distance	Sound pressure level L _p in dB
Jet plane, 30 m distance	140
Pain threshold	130
Indisposition	120
Chainsaw, 1 m distance	110
Disco, 1 m to loudspeaker	100
Diesel engine, 10 m distance	90
Street, 5 m distance	80
Vacuum cleaner, 1 m distance	70
Normal speech, 1 m distance	60
Normal flat, silent area	50
Library	40
Bedroom at night	30
Silence in TV-Studio	20
Leaf rustling in the distance	10
Auditory threshold	0

Office building	Recommended reverberation time T (s)
Single office	0.6 ... 1.0
Multiple persons office	0.6 ... 0.8
Open plan office	0.4 ... 0.6
Corridor	0.8 ... 1.0
Canteen	0.6 ... 0.8
Switchboard	0.4 ... 0.6

Recommended reverberation time T (s) for several building and room types (selection)

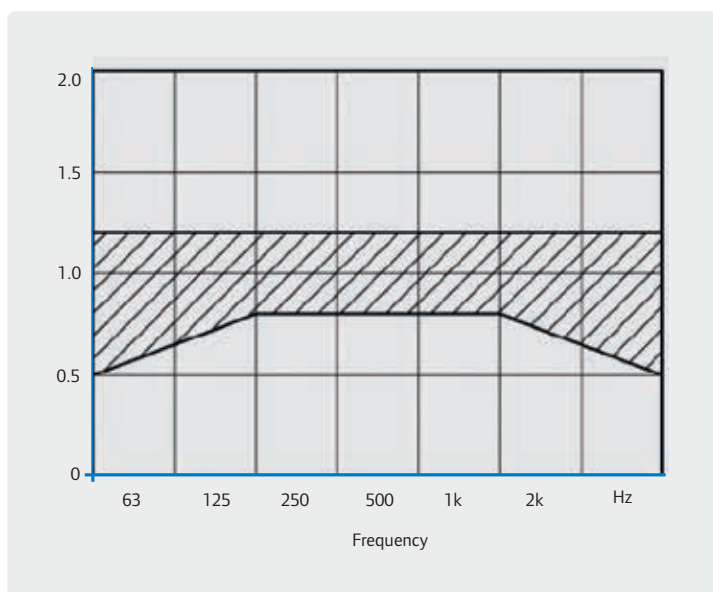

Recommended reverberation time T for sound in relation with frequency

8.2 Relevant standards

- DIN EN ISO 3382: Acoustics - Measurement of room acoustic parameters
- DIN EN ISO 11690: Acoustics - Recommended practice for the design of low-noise workplaces containing machinery
- DIN 18041: Acoustic quality in small to medium-sized rooms
- VDI 2569: Sound protection and acoustical design in offices (German guideline)

8.3 Acoustic solutions

A number of acoustic solutions are available which have little or no impact on the function of the TABS system. Any significant reduction in heat transfer between the space and the concrete ceiling caused by suspended ceilings or other types of acoustic insulation should be avoided. The main factors in room acoustic solutions are: reverberation time, frequency related elements and the reduction of direct sound propagation. In general, taking into account a combination of these factors leads to appropriate room acoustics.

- Ceiling panel
- Active ceiling panel
- Ceiling baffle
- Integrated absorber
- Wall elements
- Furniture
- Floor construction
- Carpet
- Acoustic plaster

Floor covering

Upward heat transfer from the concrete slab is often restricted through raised floors or impact sound insulation. In this case, sound-absorbing floor covering may be used.

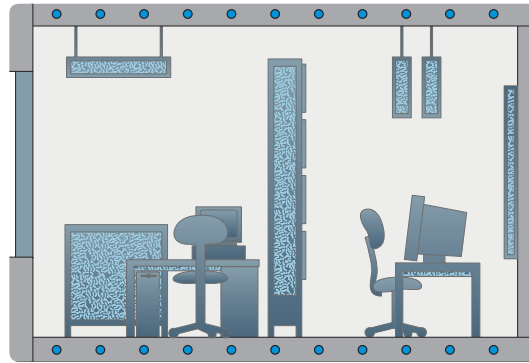

Furniture and fittings

Furniture, shelves, partitions, tables and chairs may also be used as acoustic absorber surfaces. Chairs with padded seats and backs, and shelves with sound absorbing side and back panels (perforated wooden panels) increase acoustic absorption. Installation of additional absorber material under tables could be considered. In open-plan offices, partitions with appropriate materials on both sides can provide acoustic absorption. Decorative wall coverings could also be used to improve acoustics.

Important design advice: An acoustician should be involved in the design phase.

8.3.1 Acoustic plaster

One of the main functions of acoustic plaster is to reduce the reverberation period. Acoustic plaster is normally installed on the completed ceiling. Installing acoustic plaster on a thermally activated slab will reduce

the thermal output considerably. In general, it is valid to note that smaller absorption elements are less expensive than the plastering of the complete ceiling.

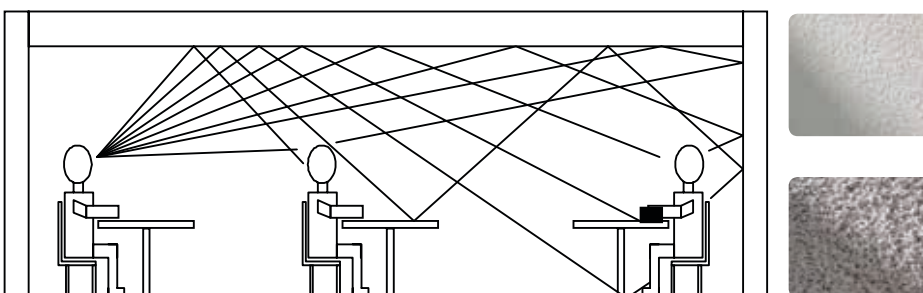

Sound propagation and multi-reflection acoustic plaster, "splatter plaster" (Sto®)

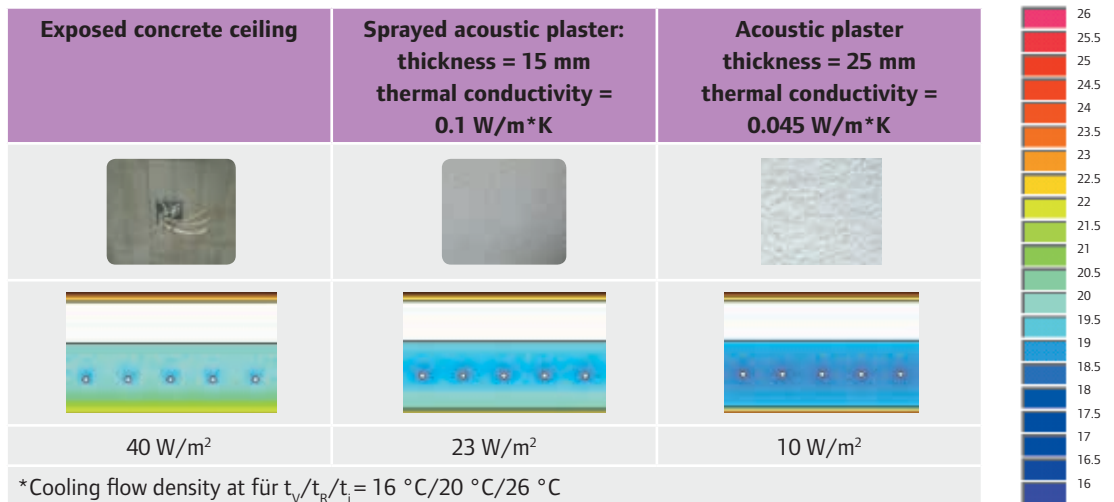

Reduction of cooling flow density of TABS-ceiling as a function of plaster type

8.3.2 Wall, floor & furniture absorbers

Good acoustic results are possible if, for example, wall, floor and furniture absorbers are combined with an acoustic concept. Modern furniture absorbers are

available in many different designs and colours. They reduce the reverberation time. Floor absorbers like carpet reduce the step sound.

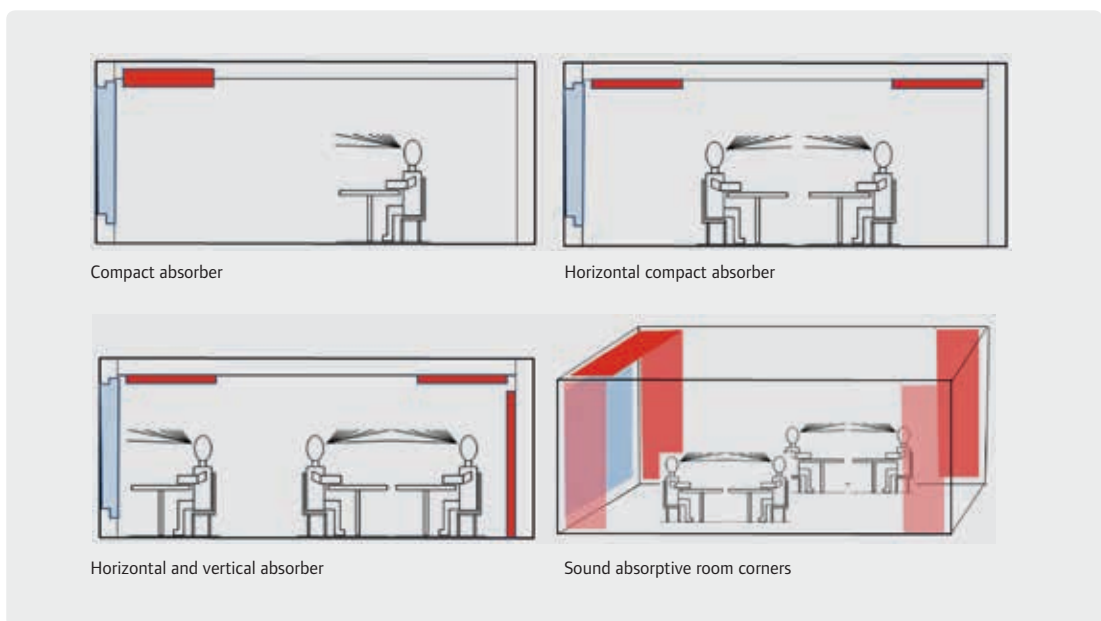

Offices for more than 2-3 people have, in general, a higher demand for acoustic solutions. Suspended ceilings are traditionally used for acoustic functions. Due to the high negative impact on TABS output, a full area suspended ceiling is not useful. However, there are good examples of different acoustic solutions in an open plan office:

- Acoustic furniture
- Carpet on double floor
- Ceiling elements



8.3.3 Wall partitions

Open plan offices are good for communication as they enhance the exchange of information between employees. With bad room acoustics however, it can happen that employees are distracted by the conversation of

their colleagues. Wall partitions reduce the sound level of direct sound, but indirect sound reflected by the ceiling is not reduced.

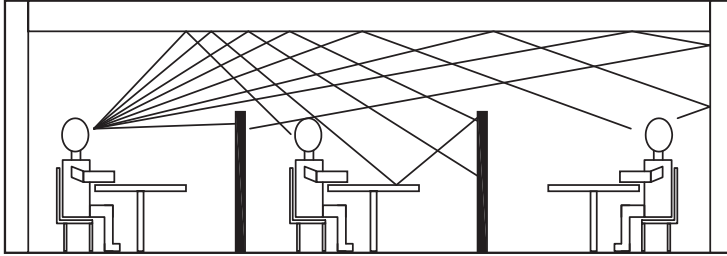

A common acoustic solution is the combination of mobile walls and ceiling elements. Thus, direct sound is reduced by mobile walls and indirect sound by ceiling panels.

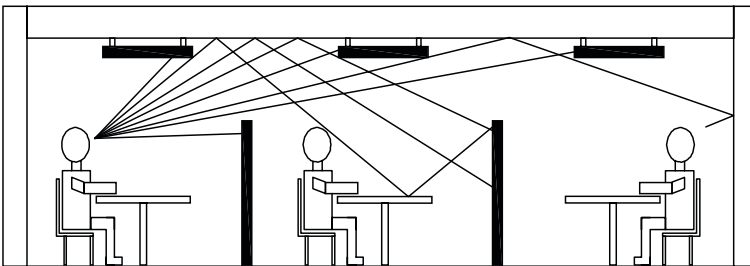

8.3.4 Vertical acoustic absorber

The picture below shows the function of a vertical sound absorber. Only a small surface is connected to the ceiling, which means that its influence on the TABS system is very low, whilst acoustic absorption is very good.

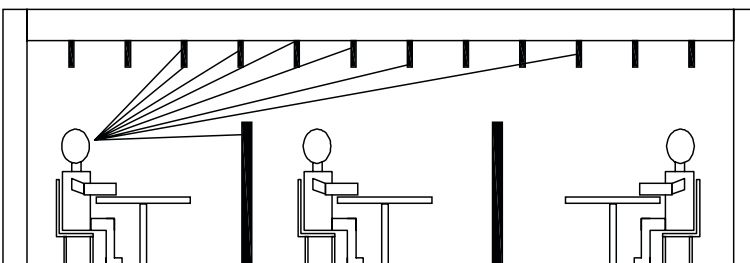

8.3.5 Ceiling integrated absorber strips

The integrated ceiling absorber strip (research and development project of Fraunhofer IRB) provides an additional possibility to improve the reverberation time.

There are 2 suitable materials used for the absorber strip:

1. Porous absorber (PA, nonwoven or of porous glass-foam)
2. Micro-perforated absorber (MPA).

Both the acoustically active area and the thermal properties of these strips are very good.

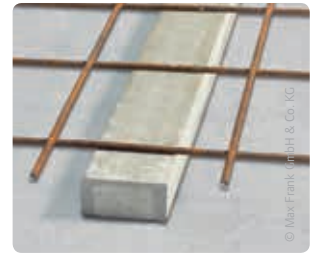
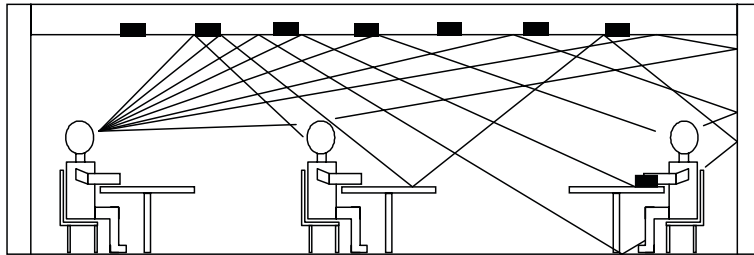

8.3.6 Activated acoustic elements

Activated acoustic elements e.g. Zent-Frenger Velum consist of an enclosed metal cassette in which a heating/cooling coil is integrated along with additional sound absorbing material. The canopy surfaces are made of powder-coated aluminium or galvanized sheet steel. The special heating/cooling coil made of dual heat conducting profiles with copper serpentine pipe-work is form-fitted and friction-locked to the double-sided sheet metal covering of the ceiling canopy.

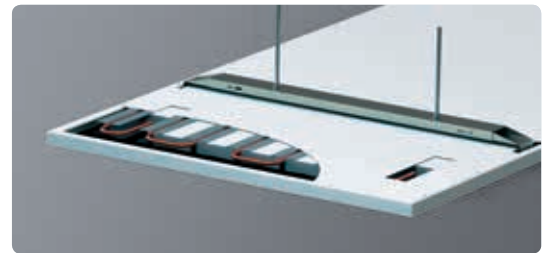

Structure of a Uponor Velum ceiling panel with mounting rail for suspension of the component using threaded rods (folding and three-dimensionally adjustable)

Acoustics

The integrated acoustic fleece and the sound absorbing insulation filling provide very effective sound absorption and excellent room acoustics. Due to the sound absorbing elements integrated in the ceiling canopy, the cooling capacity remains high. The sound absorption values for the suspension heights of 200 mm and 400 mm are indicated as equivalent sound absorption areas in diagram 2. The sound absorption coefficient α_s is calculated from the equivalent sound absorption area and the canopy surface. The weighted sound absorption coefficient α_w is calculated according to EN ISO 11654.

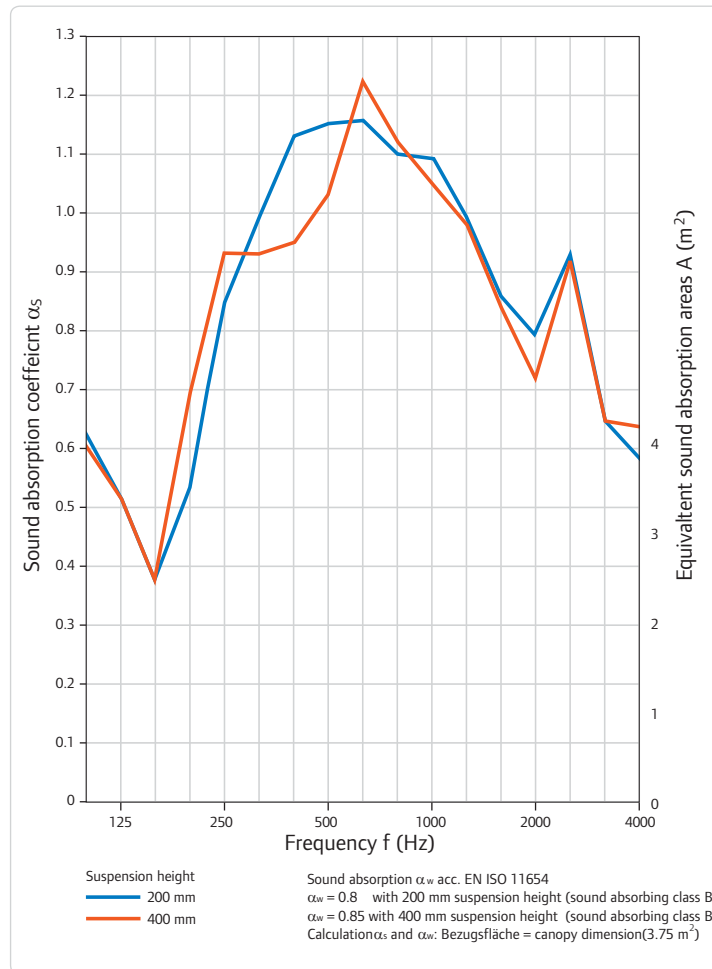

Sound absorption of the ceiling canopy system Uponor Velum with acoustic fleece and insulation material tested according to EN ISO 354

8.4 Effect of acoustic measurements in heating/cooling capacity of TABS

The effects on the cooling capacity of TABS when combined with acoustic ceiling elements was measured by Peter Weitzmann BuildDesk A/S, Emanuele Pittarello DTU and Bjarne W. Olesen DTU in a test facility.

Generally, it has been assumed that in order to maintain sufficient cooling capacity from the mainly radiant heat transfer, the concrete ceiling must be exposed directly to the room. This in practice would therefore impede the use of TABS in open plan offices where acoustic ceilings are needed to ensure acceptable acoustic conditions. Measurements were made in a room equipped with TABS combined with an acoustic ceiling that covered parts of the ceiling, so that both acoustic and thermal

requirements could be met. In the measurements, 35 %, 47 %, 67 % (two different patterns), 70 %, 83 % and 100 % were covered, as well as four different configurations using baffles. Both thermal and acoustic properties were tested. The results showed that even with a covering of 83 % of the ceiling surface area, the cooling capacity was still around 70 % of the uncovered ceiling for the same temperature difference between mean fluid temperature and room operative temperature. At the same time, the reverberation time in the room was clearly acceptable. This shows that acoustic ceilings and TABS can be combined.

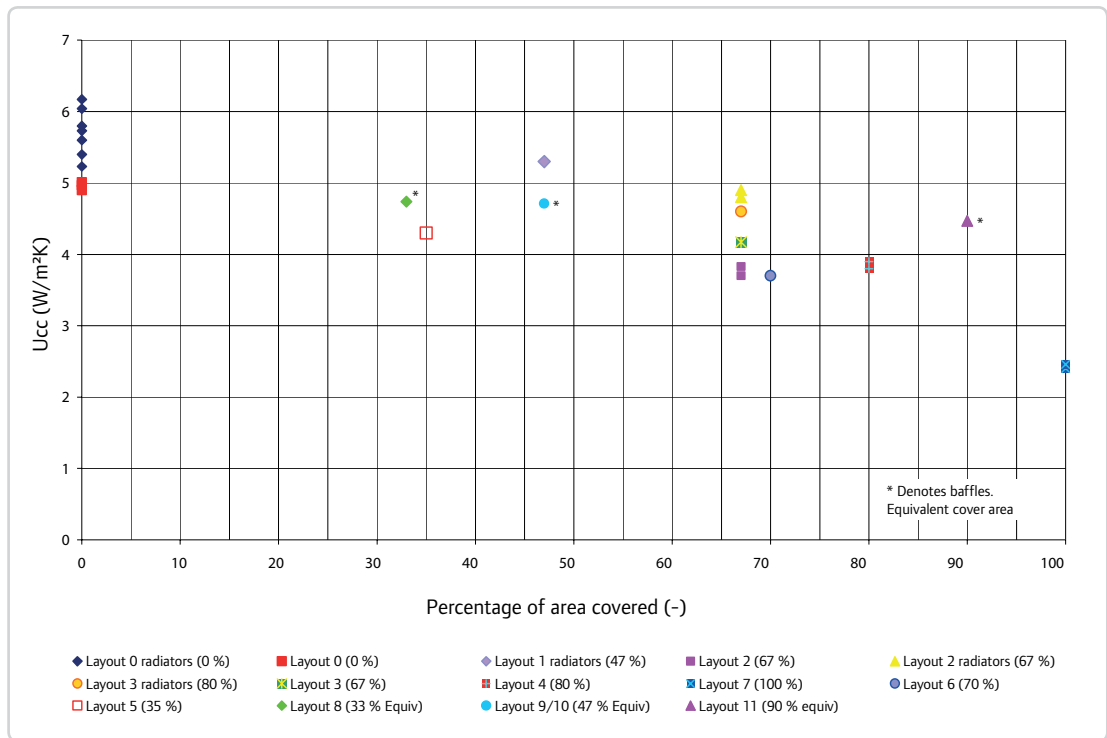

The cooling capacity coefficient as function of the covered percentage of the ceiling surface

$$U_{cc} = \frac{\dot{m}_{fluid} \cdot c_{p, fluid} \cdot (T_{return} - T_{supply})}{A_{deck} \cdot (T_{room} - T_{fluid})} \quad (W/m^2K)$$

Layout	Number	125	250	500	1000	2000	4000	SAA
Without panels	0	0.77	1.33	1.5	1.41	1.34	1.05	0.015
100 % covered	7	0.54	0.66	0.56	0.6	0.64	0.57	0.52
70 % covered	6	0.66	0.69	0.61	0.62	0.66	0.58	0.46
35 % covered	5	0.63	0.84	0.73	0.67	0.66	0.58	0.38
10 baffles	8	0.5	0.77	0.7	0.65	0.66	0.6	0.43
14 baffles	10	0.48	0.69	0.63	0.58	0.59	0.52	0.53
27 baffles	11	0.47	0.64	0.58	0.54	0.57	0.52	0.57

References

Theatre and cultural centre, Daoiz y Velarde complex Madrid, Spain

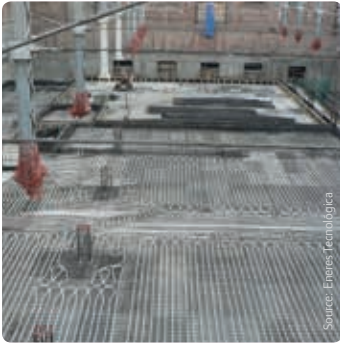

Energy efficiency and low impact add high value to the building



9,000 m² of TABS provide for a comfortable indoor environment

The architectural ensemble of Daoiz and Velarde, in the District of Retiro, hosts a children's theatre and cultural centre.

Performance is part of investment in cultural infrastructure of the city of Madrid, and the overall project has been developed by the Department of Historical Heritage in the arts sector. The objective of this initiative is to preserve the architecture of the whole of Daoiz and Velarde, a representative sample of Madrid's industrial and military heritage.

At the same time, the municipal government will equip the new space with modern infrastructures and locals can enjoy a large cultural complex. Children's theatre represents the first stage of the total investment dedicated exclusively to children. The new cultural center will have a large exhibition hall, assembly hall and multi-purpose classrooms, among other provisions. In total, almost 7,000 m² are dedicated to the diffusion of culture.

The developer's main objective was to build the new facilities with energy efficiency in mind, and to incorporate the most advanced solutions in terms of indoor environment and energy production. The objective was to provide high added value to the building. Another important point was finding a technical-financial balance with regard to the initial and operational costs over the next years.

Project data

- 12,000 m² Children's theatre and cultural centre
- 9,000 m² of Uponor TABS cooling
- Developer: Madrid Gobernament
- Architect: Rafael de la Hoz
- Completion: 2013



The refurbishment of this former industrial building, and abandoned barracks, has been carried out to maximise sustainability as regards energy efficiency and the integration of renewable energy capture systems.

Manchester Metropolitan University, Business School Manchester, United Kingdom



A low energy University building incorporating thermal mass, natural daylight, controlled ventilation, a number of integrated energy generation features and ground source heat pumps



13,500 m² of Uponor TABS cooling in semi-precast concrete planks

Design of the £65m new Business School at Manchester Metropolitan University was driven by the University's ambition to create a low energy building utilising thermal mass, natural daylight and controlled ventilation.

Uponor Thermally Active Building Systems (TABS) was chosen for the scheme. A precast concrete floor slab with a fair faced permanent formwork concrete was utilised, which incorporated Uponor PE-Xa pipes embedded beneath the soffit surface. Visual appearance, colour and finish of the concrete was of particular importance to the design. Regulating the temperature of the exposed concrete to 20°C meant that the room's air temperature would always be maintained between 21°C and 26°C. With groundwater utilised as a cooling source, a chilled water circuit is passed through the concrete, creating a radiant space cooling system.

Mechanical ventilation is provided to most areas using the raised access floor as a supply plenum. Return air passes into the atrium via cross talk attenuators, where it rises to the air handling plant rooms at roof level for heat recovery. Therefore, cooling is provided by a combination of cooled supply air and the Uponor TABS system in the precast floor planks.

The inherent thermal mass, fire resistance and sound insulation of the concrete structure have also contributed to a BREEAM rating of 'Excellent'.

Project data

- 20,000 m² University building with 8 storeys
- 13,500 m² of Uponor TABS cooling in semi-precast concrete planks
- 2,000 m² of Uponor underfloor heating to the atrium area
- Client: Manchester Metropolitan University
- Architect: Fielden Clegg Bradley Studios
- Main Contractor: Sir Robert McAlpine
- M&E Engineer: AECOM
- Completion: 2011

breeam EXCELLENT



With a history dating back 150 years, the Manchester Metropolitan University combines tradition and contemporary. Its modern low energy building results from the university's million investment programme set up to ensure a strong future.



With the overall energy concept, the annual primary energy demand of the Ericusspitze building is below 100 Kilowatt hours per m².

Ericusspitze, Spiegelhaus Hamburg, Germany



The Uponor Contec modules are supplied with geothermal energy

The new headquarters for the Spiegel Group is located at the Ericusspitze in Hamburg, Germany. Uponor's concrete core activation ensures pleasant temperature levels throughout the building at all times.

The basic heating and cooling of the Spiegel Group building is provided by Uponor Contec concrete core activation. Approximately 8,150 m² of the ceiling surface was equipped with prefabricated Uponor Contec modules.

In so doing, the thermal ceiling activation achieves coverage of up to 30 % of the base loads. The remaining heating and cooling loads are covered using suspended ceiling panels that are also thermally active. The loads remaining for climate control are covered using a heating-cooling panel, and in areas with increased cooling needs, using a conventional air conditioning system.

For heating, the energy retrieved from the geothermal system is sufficient to cover the base loads using concrete core activation as well as the ceiling panels with an intake temperature of 35°C and a return temperature of 30°C. To address demand peaks in secondary areas of the building and for additional heating, district heating is used according to prevailing demand.

When it comes to cooling, higher thermal power is required to supply the cooling panels. To achieve this, the cooling circuits of the concrete core activation used here are set up as separate cooling circuits.

Project data

- 50,000 m² Office area
- 8,150 m² of Uponor Contec cooling and heating
- Architect: Henning Larsen Architects
- Completion: 2011



The entire business park reflects the overall concept: buildings combining high technology with environmental friendliness.

Multifunctional complex Premium West Moscow, Russia



Pe-PEX pipes are integrated into the building structure



Final checks on site before the concrete pour

The multifunctional complex Premium West occupies 10 ha next to the Moscow motorway ring MKAD. Construction began in 2004-2005. Today, car dealers such as AUDI, Skoda, Volkswagen, KIA operate successfully here, as well as SafeSpace - the European operator of individual storage. In 2012 a parking space for 2000 cars was commissioned. A fitness club is due to open at the end of 2013.

Within the framework of the project, there is: a showroom which is currently under construction, a Class A commercial and storage building, which is currently in the process of being reconstructed, and the Class A energy-efficient Premium West business centre consisting of eight storeys, which is the core of the complex and will soon be complete. The second phase of the business park construction, is due to be launched in the near future and will accommodate offices, retail spaces and in-house parking.

Impressive features of Premium West office center:

- Smart home system
- Geothermal heating and cooling systems
- Unique facades, combining advantages of monolith and glass
- Radiant temperature control system
- Landscape design

Project data

- 112,000 m² Multifunctional area
- 25,000 m² of Uponor TABS cooling and heating
- Developer: GEMA Invest
- Completion: under formation

Elena Semenikhina, Director of Development GEMA Invest

“Premium West is unique in terms of energy-efficiency and the composition of engineering systems.”

Bayer MaterialScience Qingdao, China



The zero emission building houses the administration of the Bayer MaterialScience plant



Uponor Opti Y ceiling panels in the reception area



Installation of the TABS modules

The Bayer MaterialScience plant in Qingdao, is the first of its kind in China, developed by Bayer MaterialScience under the innovative EcoCommercial Building (ECB) Program. The ECB Program is a global initiative providing an all-in-one solution, through collective work from Bayer and its network of building partners, to meet demand in China and across the globe, creating highly efficient and cost effective commercial and public buildings.

The 1,000 m² zero emissions building holds 60 office workplaces and represents a building system where energy needs are covered through long-term efficiency gains and renewable energy generation. The building uses 1,000 m² of photovoltaic panels to provide solar power, generating 80.35 MWh of electricity every year. Uponor's Thermally Activated Building Systems (TABS) combined with a Geothermal Source Heat Pump and an energy saving building envelope provide a pleasant room climate during all seasons.

Uponor TABS is responsible for covering the sensible cooling/heating load of the office area. By using favourable night electricity, thermal energy can be stored in the concrete structure overnight. This can be used to compensate the cooling/heating load for the following day. Due to supply temperatures close to room temperatures, the system is ideally suited for the use of ground energy or the use of a free cooling system at night time, which is especially beneficial and will consequently decrease the operation costs. The Uponor OPTI Y ceiling panels are fast reacting and adapt to the load fluctuations in the office area, which provides unique individual user comfort. The active ceiling panels are distributed by a four pipe system, which allows cooling and heating in different areas at the same time, according to the users' need.

Project data

- 1,000 m² of Uponor TABS and Uponor OPTI Y ceiling panels in combination with a heat recovery system
- Client: Bayer Material Science (China) Co, Ltd
- Architect: Bayer Technology and Engineering (Shanghai) Co, Ltd
- Completion: 2011



GOLD



A heat recovery system reduces the loss of energy from the air handling unit for ventilation. This achieves 80% of heat recovery rate with technology provided by local suppliers, while electrical energy consumption is reduced greatly due to LED energy-efficient lighting technology.

Sheikh Zayed Desert Learning Centre, Al Ain, United Arab Emirates



The Uponor TABS cooling system is incorporated into a BubbleDeck® construction



High cooling loads of 1.5 MW are mainly delivered from the Uponor TABS of 7,500 m²

Located in one of the hottest and most humid climates on earth, this multifunctional education building was designed with the target of reducing the life cycle costs and environmental impact, to provide a leading reference for sustainable architecture in the Emirates. This is the first building to be developed as a part of the master plan for the Al Ain Zoo, which also includes a safari area, hotels, a shopping centre and residential areas. The Centre will function as an educational museum and research centre for desert and environment related issues.

The building has obtained LEED Platinum and Estidama five pearls design rating. This achievement is a result of a combination of passive and active measures in saving energy and water consumption, as well as using partially local and recycled materials. This makes it the first sustainable development by the government to attain the highest sustainability rating.

The challenging high cooling loads of 1.5 MW are mainly delivered by the Uponor Thermally Active Building Systems (TABS) of 7500 m², with an average water temperature of 16 °C. The building is equipped with six adiabatic cooling towers, minimising the need for cooling water. Apart from the compression chillers, the building is equipped with solar absorption chillers, enabling solar cooling. The solar collectors, with an area of 1.134 m², provide 825 kWh/m²/a.

Project data

- 7,500 m² of Uponor TABS cooling system
- Incorporated into structural "Bubbledeck" construction
- Concept and design development by Uponor
- Architect: Chalabi Architekten & Partner – ZT GmbH
- Contractor: S.O.L.I.D. GmbH; Züblin Abu Dhabi (subsidiary of Strabag Intern. GmbH)
- Consultant : S.O.L.I.D. GmbH, iC Consultants
- Client: Al Ain Wildlife Park Resort
- Completion: 2013



**FIVE PEARLS
DESIGN
RATING**



PLATINUM

HE Falah Al Ahabbi, general manager UPC

“By achieving the highest Pearl Rating, the Sheikh Zayed Desert Learning Centre will be the catalyst for all upcoming sustainability-driven projects.”



The LEED Platinum standard certified building with its 13.000 m², offers areas for auditorium, theatre, cafés, galleries and one library. At full operation 1,600 visitors per hour are expected. Moreover, the building is to be certified with 5 Pearls according to the local reference System Estidama.

Ignatius Loyola Ecotech Campus Cikarang Baru, Indonesia



Installation of Uponor TABS radiant cooling



Studying in a sustainable building with optimum comfort

Built to carry the principles of sustainable construction, the Ignatius Loyola Ecotech Campus in Cikarang, West Java, is the new icon of environmentally-friendly buildings in Indonesia. The four-storey building, with a total floor area of 3,672 m² was designed to consume less than half the energy required by a standard building of comparable size.

Uponor, with partners Holcim and Sanwell, made a significant contribution with the design and supply of the radiant cooling solutions. The high temperatures in tropical countries such as Indonesia are often addressed by using conventional air conditioners. The convenience gained must be compensated through excessive energy use and strong air draught. An alternative solution to this challenge is the application of a radiant cooling system. At Ignatius Loyola Ecotech Campus two different systems have been applied: Uponor Thermally Activated Building System (TABS) and Uponor underfloor cooling – working together to achieve optimum comfort for students and lecturers.

Other elements contributing to less energy consumption are the building shading that is designed to provide passive cooling, and the butterfly roof that collects rainwater and which is equipped to support the installation of photovoltaic panels to cover the building's electricity demand.

Project data

- 3,672 m² university building
- 2.000 m² Uponor TABS
- 500 m² Uponor underfloor cooling
- Client: Akademi Teknik Mesin Industri (ATMI)
- Architect: PT Urbane Indonesia
- Main Contractor: PT Multi Sarana Propertindo (Multi pro)
- M&E Engineer: PT Metakam Pranata
- Completion: 2012



While Uponor TABS utilises the structural concrete slab that radiates cool air upwards and downwards, the underfloor cooling system uses the floor concrete screed of the ground floor to radiate cool air upwards, thus achieving a pleasant overall atmosphere that benefits students and lecturers.

© Hentri PA

Tender texts

10.1 BIC system

Preface and system description

Preface

Uponor Contec BIC is a system for thermal activation of concrete slabs by means of water flowing through pipe registers. The thermal mass of the concrete slab is utilised by positioning the pipes directly in this structural component. The system may also be used for covering a heating base load.

System description

Pipe registers in the form of prefabricated Contec modules with integrated connection pipes of individual length for installation between site-installed lower and upper reinforcement, consisting of:

- Pipe 20 mm PE-Xa made from high-pressure cross-linked polyethylene according to EN 15875, with 5-layer, diffusion barrier and additional PEX outer layer for protection against mechanical stress, oxygen proof according to DIN 4726
- Special pipe carrier mat, Uponor Contec BIC, with integrated pipe support elements (EP 09757317/DGBM 298 08 792.8)
- Ceiling pipe lead-through element (EP 0962710/DGBM 298 08 793.6)

With Uponor liability declaration:

10-year product liability (non-lapsable) for personal and subsequent damage, irrespective of run-time of the insurance contract, provided all specified Uponor system components are used.

Construction sequence

1. Shuttering construction (building shell).
2. Position and fix ceiling pipe lead-through elements with pipe inlet and outlet opening on the shuttering to carry out pressure tests without damage to the shuttering (concrete core activation).
3. Laying of the lower reinforcement and the associated spacers (building shell).
4. Laying and alignment of the modules on the lower reinforcement according to installation plan (concrete core activation).
5. Connect Uponor Contec modules and perhaps longer connection pipes with the cooling/heating loops via couplings.
6. Lay and fix connection pipes and feed through ceiling pipe lead-through elements (concrete core activation).
7. Laying of the upper reinforcement with associated spacers (four or six legs) sitting on the shuttering (building shell).
8. Lifting of the modules into the neutral zone via the Uponor Contec Hook element method (concrete core activation).
9. Pressure test of all installed pipe registers (concrete core activation).

Installation training is provided by a member of staff from Uponor.

Transport (crane required) and intermediate storage of the Contec modules

The Uponor Contec modules are delivered upright on module transport frames for the different construction phases. A crane is required for unloading the modules from the lorry and for transporting them from intermediate storage (if applicable) to the installation level (component/floor level). Space for intermediate storage of the Contec modules delivered to the site should be made available if necessary.

Article description	Quantity	Unit	Price/unit, €	Total price, €
---------------------	----------	------	---------------	----------------

Load system Contec BIC, Uponor Contec Hook method

For thermal activation of concrete slabs, for application in residential or non-residential buildings via Uponor Contec Hook method consisting of:

- Prefabricated, project-specific module
- Pipe 20 mm PE-Xa made from high-pressure cross-linked polyethylene according to EN 15875, with 5-layer, diffusion barrier and additional PEX outer layer for protection against mechanical stress, oxygen proof according to DIN 4726
- Special pipe carrier mat made of smooth wire with integrated pipe support elements and safety edge (EP 0957 317/DGBM 298 08 792.8), without burrs or sharp edges
- Ceiling pipe lead-through element incl. 1 m protective tube with pipe entry and exit opening for:
 - 1) carrying out module pressure tests without damaging the shuttering (EP 0962710 B1/DGBM 298 08 793.6),
 - 2) precisely defined pipe runs out of the slab construction layer,
 - 3) connecting the modules to the distribution pipe. Several units can be connected in series
- Individual connection pipes positioned on the module with Uponor Multi cable ties
- Contec Hooks for lifting, precise height adjustment and stabilising the pipe level relative to the upper reinforcement (4/m²) (DGBM 298 08 790 U1) for bar thicknesses up to 15 mm

Note: Calculation per m² based on outside rectangular area of the special Uponor Contec carrier mat

Number of Contec modules:	approx	units
Max. module size:	13.5 x 2.40	m
Pipe distance:	150	mm
Weight of Contec module per m ² :	2.5	kg/m ²
Connection pipes (flow + return) per module:	m
Make:	Uponor	
Type:	Contec	

		m ²		
--	--	----------------	--	--

Article description	Quantity	Unit	Price/unit, €	Total price, €
<p>Connection pipe</p> <p>For individual connection of the Contec modules to the heating circuit manifold or a distribution pipe (if not already integrated in the module), consisting of:</p> <ul style="list-style-type: none"> ■ Pipe 20 mm PE-Xa made from high-pressure cross-linked polyethylene according to EN 15875, oxygen proof according to DIN 4726 ■ Proportional, Uponor Multi cable ties for fixing the pipes to the customer reinforcement mats Dimensions: 20 mm Make: Uponor 		m		
<p>Connection pipe "A" alternative position</p> <p>For individual connection of the Contec modules to the heating circuit manifold (if not already integrated in the module), consisting of:</p> <ul style="list-style-type: none"> ■ Pipe 20 mm PE-Xa made from high-pressure cross-linked polyethylene according to EN 15875, with 5-layer, diffusion barrier and additional PEX outer layer for protection against mechanical stress, oxygen proof according to DIN 4726 ■ Proportional, Uponor Multi cable ties for fixing the pipes to the customer reinforcement mats ■ Special pipe carrier mat made of smooth wire with integrated pipe support elements and safety edge (EP 0957 317/DGBM 298 08 792.8), without burrs or sharp edges ■ Contec Hooks for lifting, precise height adjustment and stabilising the pipe level relative to the upper reinforcement (4/m²) (DGBM 298 08 790 U1) for bar thicknesses up to 15 mm Dimensions: 20 mm Make: Uponor 		m		

Article description	Quantity	Unit	Price/unit, €	Total price, €
<p>Leak test</p> <p>Before the concrete for the slab is poured, the pipe registers should be subjected to a water pressure leak test according to ISO 11855. The test pressure must be twice the operating pressure or at least 6 bar.</p> <p>The tightness and the test pressure of all pipe registers must be checked before and during concrete pouring, and documented. Spot checks are not sufficient.</p> <p>A specialised heating system fitter must be present during concrete pouring so that any damage can be rectified immediately.</p> <p>If there is a risk of freezing, either an antifreeze agent should be used or the leak test should be carried out with air or inert gas.</p> <p>Prior to commissioning, the system must be subjected to a final leakage test according to the official contract procedure for building works (DIN 18380) with operating medium and a minimum test pressure of 1.3 times the operating pressure at any point of the system, or at least 1 bar.</p>		unit		
<p>Final inspection and interim monitoring</p> <p>Final inspection of the Uponor Contec BIC system takes place to check the position of the pipes and connections before the concrete is poured.</p> <p>Interim monitoring takes place during concreting to prevent damage through external influence.</p>		unit		

10.2 Q System

Preface/System description

Preface

Uponor Contec Q is a system for thermal activation of concrete slabs by means of water flowing through pipe registers. The thermal mass of the concrete slab is utilised by positioning the pipes directly in this structural component. The system may also be used for covering a heating base load.

System description

Pipe registers in the form of prefabricated Contec modules with integrated connection pipes of individual length for installation between site-installed lower reinforcement and upper reinforcement, consisting of:

- Pipe 20 mm PE-Xa made from high-pressure cross-linked polyethylene according to EN 15875, with 5-layer, diffusion barrier and additional PEX outer layer for protection against mechanical stress, oxygen proof according to DIN 4726
- Steel mesh. Mesh grid size 150x150 mm
- Ceiling pipe lead-through element (EP 0962710/DGBM 298 08 793.6)

With Uponor liability declaration:

10-year product liability (non-lapsable) for personal and subsequent damage, irrespective of run-time of the insurance contract, provided all specified Uponor system components are used.

Construction sequence

1. Shuttering construction (building shell)
2. Position and fix ceiling pipe lead-through elements with pipe inlet and outlet opening on the shuttering to carry out pressure tests without damage to the shuttering (concrete core activation).
3. Laying of the lower reinforcement and the associated spacers (building shell).
4. Laying and alignment of the modules on the lower reinforcement according to installation plan (concrete core activation).
5. Connect Uponor Contec modules and perhaps longer connection pipes with the cooling/heating loops via couplings.
6. Lay and fix connection pipes and feed through ceiling pipe lead-through elements (concrete core activation).
7. Laying of the upper reinforcement with associated spacers (four or six legs) sitting on the shuttering (building shell)
8. Lifting of the modules into the neutral zone via the Uponor Contec Hook element method (concrete core activation).
9. Pressure test of all installed pipe registers (concrete core activation).

Installation training is provided by a member of staff from Uponor.

Transport (crane required) and intermediate storage of the Contec modules

The Uponor Contec modules are delivered upright on module transport frames for the different construction phases. A crane is required for unloading the modules from the lorry and for transporting them from intermediate storage (if applicable) to the installation level (component/floor level). Space for intermediate storage of the Contec modules delivered to the site should be made available if necessary.

Article description	Quantity	Unit	Price/unit, €	Total price, €
<p>Load system Contec Q, Uponor Contec Hook method</p> <p>For thermal activation of concrete slabs, for application in residential or non-residential buildings via steel mesh consisting of:</p> <ul style="list-style-type: none"> ■ Prefabricated, project-specific module ■ Pipe 20 mm PE-Xa made from high-pressure cross-linked polyethylene according to EN 15875, with 5-layer, diffusion barrier and additional PEX outer layer for protection against mechanical stress, oxygen proof according to DIN 4726 ■ Steel mesh, grid size 150 x 150 mm ■ Ceiling pipe lead-through element incl. 1 m protective tube with pipe entry and exit opening for: <ul style="list-style-type: none"> 1) carrying out module pressure tests without damaging the shuttering (EP 0962710 B1/DGBM 298 08 793.6), 2) precisely defined pipe runs out of the slab construction layer, 3) connecting the modules to the distribution pipe. Several units can be connected in series ■ Individual connection pipes positioned on the module with Uponor Multi cable ties ■ Contec Hooks for lifting, precise height adjustment and stabilising the pipe level relative to the upper reinforcement (4/m²) (DGBM 298 08 790 U1) for bar thicknesses up to 15 mm <p>Note: Calculation per m² based on outside rectangular area of the special Uponor Contec support mat</p> <p>Max. module size: 5.0 x 2.15 m Pipe distance: 150 mm Weight of Contec module per m²: 2.5 kg/m² Connection pipes (flow + return) per module: m Make: Uponor Type: Contec Q</p>		m ²		

Article description	Quantity	Unit	Price/unit, €	Total price, €
<p>Connection pipe</p> <p>For individual connection of the Contec modules to the heating circuit manifold or a distribution pipe (if not already integrated in the module), consisting of:</p> <ul style="list-style-type: none"> ■ Pipe 20 mm PE-Xa made from high-pressure cross-linked polyethylene according to EN 15875, with 5-layer, diffusion barrier and additional PEX outer layer for protection against mechanical stress, oxygen proof according to DIN 4726 ■ Proportional, Uponor Multi cable ties for fixing the pipes to the customer reinforcement mats Dimensions: 20 mm Make: Uponor 		m		
<p>Connection pipe "A" alternative position</p> <p>For individual connection of the Contec modules to the heating circuit manifold (if not already integrated in the module), consisting of:</p> <ul style="list-style-type: none"> ■ Pipe 20 mm PE-Xa with an oxygen diffusion layer of EVOH (ethylene vinyl alcohol). Compliant with EN ISO 15875 "Plastic piping systems for hot and cold water installation cross-linked polyethylene" and fulfils the requirement for oxygen diffusion resistance as per DIN 4726 ■ Proportional, Uponor Multi cable ties for fixing the pipes to the customer reinforcement mats ■ Steel mesh, grid size 150 x 150 mm ■ Contec Hooks for lifting, precise height adjustment and stabilising the pipe level relative to the upper reinforcement (4/m²) (DGBM 298 08 790 U1) for bar thicknesses up to 15 mm Dimensions: 20 mm Make: Uponor 		m		

Article description	Quantity	Unit	Price/unit, €	Total price, €
<p>Leak test</p> <p>Before the concrete for the slab is poured, the pipe registers should be subjected to a water pressure leak test according to EN 1264-4. The test pressure must be twice the operating pressure or at least 6 bar.</p> <p>The tightness and the test pressure of all pipe registers must be checked before and during concrete pouring, and documented. Spot checks are not sufficient.</p> <p>A specialised heating system fitter must be present during concrete pouring so that any damage can be rectified immediately.</p> <p>If there is a risk of freezing, either an antifreeze agent should be used or the leak test should be carried out with air or inert gas.</p> <p>Prior to commissioning, the system must be subjected to a final leakage test according to the official contract procedure for building works (DIN 18380) with operating medium and a minimum test pressure of 1.3 times the operating pressure at any point of the system, or at least 1 bar.</p>		unit		
<p>Final inspection and interim monitoring</p> <p>Final inspection of the Uponor Contec Q system takes place to check the position of the pipes and connections before the concrete is poured.</p> <p>Interim monitoring takes place during concreting to prevent damage through external influence.</p>		unit		

Uponor is an international market leader, striving to provide better plumbing, indoor climate and infrastructure solutions across Europe, North America and in selected international markets.

In close partnership with building industry professionals we are continuously seeking out innovative ways to ensure our systems offer the most efficient, reliable and high-performing solutions available to residential and commercial structures around the globe.

All our solutions are designed to enrich people's way of life: fast and easy to install, conserving water and energy, providing comfort and health, and giving peace of mind.



Comfort

Cosiness, ease and comfort – words easily said. We deliver proof. With solutions that not only make your work easier, but also bring more quality of life to your customers. Every day. At home or at work. And often, you can't even see them.



Sustainability

For us, sustainability means doing things for which we can still answer for tomorrow. We focus on environmentally friendly materials and innovative technologies, to save energy and reduce CO₂ emissions.



Health

How does drinking water stay 100 percent clean and fresh? Which heating system cares for people with allergies and avoids draughts and moist walls? Questions like these – and the right answers – are what count for us. Because only the best technology keeps us healthy.



Safety

Safety is a basic human need. If nothing happens, everything's perfect. Thanks to our many years of experience, you can trust in the quality and reliability of the systems we install. So that you can take care of what matters to you – safely.



Efficiency

When everything runs smoothly, fast and reliably for you, we call it efficiency. And that is precisely our aim – from planning and installation to long-term use – to always meet your precise requirements. With time and cost benefits that will delight you!