

Chapter 6:

Installation methods

This chapter profiles a number of radiant floor and ceiling installation techniques and some helpful hints. Each page includes a detailed illustration, as well as how, where and what to look for when installing radiant heating. Listed below are several general categories of installation methods with several approaches detailed within these categories.

- Slab on or below grade
- Poured-floor underlayment
 - Fast Trak™
 - Staple down
- Dry above
 - Quik Trak® for floors
- Staple up
 - Joist Trak™ panels
 - Joist heating
- Radiant wall
 - Quik Trak for walls
- Radiant ceiling
 - Joist Trak panels

Site preparations

The key to any successful installation is coordination and preparation of the project site. A professional, cooperative approach will make the installation a positive experience for all involved. Respect the work of others. There are phases to the construction schedule. A little planning and coordination will streamline project installation.

Phase 1: Preparatory — Ensure the latest changes to the design are incorporated to avoid work stoppage or distractions during the installation phases. Coordination between other trade personnel on the site is crucial for an effective and efficient installation. Normally, the general contractor is responsible for this coordination. If needed, coordinate between the other heating, cooling and electrical trades yourself to eliminate any possible conflicts.

Phase 2: Initial — Take the time to assign the loop lengths used from each piping coil. This effort will minimize waste piping. Use a piping uncoiler. A good uncoiler eliminates needing another person for the job.

If the preparatory phase is executed correctly, the installer can quickly run the supply and return piping and low-voltage wiring for the manifold locations with minimal conflict. Coordinate with the carpenters for each manifold location rough-in. Remember to let the electrician know your requirements throughout the structure as well as in the mechanical room.

Be sure to keep the jobsite clear of debris and tools. The general contractor should coordinate a debris collection on the jobsite to facilitate cleanup. Plan for each day's scheduled work to ensure the availability of materials and labor.

Phase 3: In progress — Coordinate the piping installation to minimize other trade traffic over the exposed piping. Pressure test from each manifold location. Install isolation ball valves on the supply and return piping to the manifold at the manifold location. This isolates the manifold and distribution piping from the supply and return piping for air testing. The sequence for air testing begins at the manifolds, then the supply and return piping and finally within the mechanical room.

When running low-voltage wiring, always run more wire in the bundle than needed. For example, if the thermostat requires two wires for proper operation, run at least three-wire thermostat wire. The additional wire comes in handy should one of the wires break within the bundle. If only two wires are installed, a lot of time and money is spent trying to find the location of the break. The cost difference is insignificant between two-wire and three-wire thermostat wire, but it can save profit on a job.

It is a good practice to draw the mechanical layout before construction

begins. The drawing helps identify any potential problems, which can be corrected prior to installation. The drawing also helps identify products for the final mechanical material list.

Phase 4: Completion — Once the piping installation is complete with connections to the manifold, pressure test it to a minimum of 60 psi for at least 24 hours (or to local code requirement) to ensure system integrity. Also, keep the system under pressure during the concrete pour or when other trades are working in the area of the piping. Pressurize the system with air. If water is used, you must drain and blow out the system after the pour to prevent freezing. Water is not recommended when weather is close to freezing since it is nearly impossible to completely drain the system.

Assemble a binder for the end user that contains all the heat loss, design and performance information for the radiant floor system. Add other component information, including warranty documentation. If involved with service support, offer a service contract for the system.

Phase 5: Testing and start up — Review the mechanical drawings in **Chapter 13** for placement of the initial fill stations. Proper placement will save time when filling and bleeding the system. Using an air eliminator in the boiler room helps eliminate micro air bubbles from the system. The air eliminator is usually installed with the expansion tank piped in from below. If an automatic fill station is used, it is normally installed between the expansion tank and the air eliminator.

Follow the manufacturer's instructions when testing all electrical components. Ensure all thermostats function properly, and activate the corresponding thermal actuator, zone valve or circulator. After the system is filled and bled of air, fire the boiler and pumps to ensure proper operation.

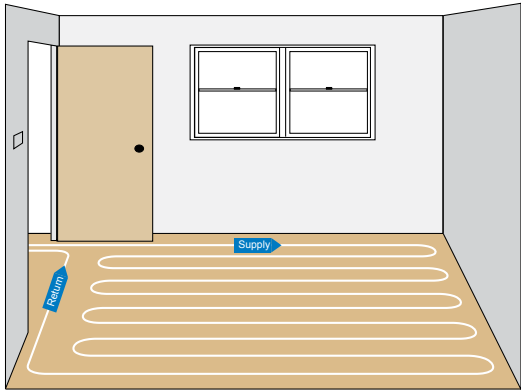

Figure 6-1: Single-wall serpentine piping layout

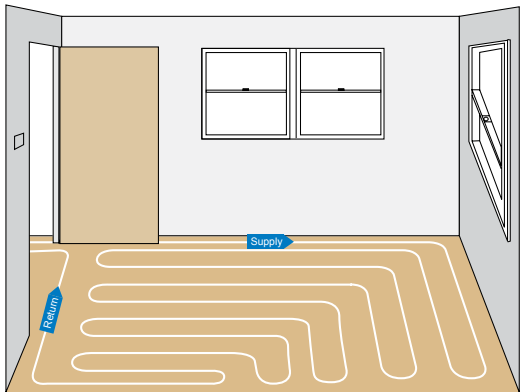

Figure 6-2: Double-wall serpentine piping layout

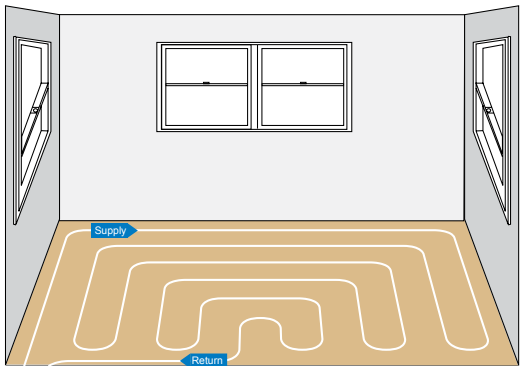

Figure 6-3: Triple-wall serpentine piping layout

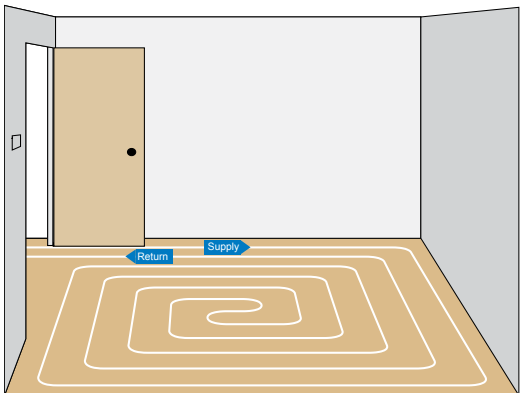

Figure 6-4: Counter flow piping layout

Installation

The following section addresses some common installation procedures and material use.

Review and understand material capabilities and limitations, and ensure compliance with local and state code requirements. Establish good communication with the code inspectors in your area to avoid any surprises. Challenges may arise when different installation practices or components are not clearly addressed in the codes. If you have questions concerning the codes, contact your local inspector. Most inspectors appreciate working with proactive contractors.

Piping layout patterns

The four most common piping layout patterns are single-wall serpentine, double-wall serpentine, triple-wall serpentine and counter flow. The object of each method is to replace the heat loss of the zone where it occurs as precisely as possible. This is accomplished by supplying the warmest water to the areas of the zone with the highest heat loss. As the heat loss diminishes, so does the heat requirement. More than one pattern may be used within a single loop or when an area requires multiple loops.

Single-wall serpentine —

Use this pattern when a single wall represents the major heat loss of the zone. Feed the supply directly to the high heat-loss wall and then serpentine toward the lower heat-loss area. Piping runs start 6 inches from walls or nailing surfaces. Six-inch on-center piping runs are often installed 12 to 18 inches from the exterior wall to improve response time (see **Figure 6-1**).

Double-wall serpentine —

Use this pattern when two adjacent walls represent the major heat loss of the room. Feed the supply directly to either of the

heat-loss walls and then serpentine toward the lower heat-loss area in an alternating pattern against the two heat-loss walls. Piping runs start 6 inches from walls or nailing surfaces. Six-inch on-center piping runs are often installed 12 to 18 inches from the exterior wall to improve response time (see **Figure 6-2**).

Triple-wall serpentine —

Use this pattern when three walls represent the major heat loss of the room. Feed the supply along the heat-loss walls in an alternating pattern and serpentine toward the lower heat-loss area of the room. Piping runs start 6 inches from walls or nailing surfaces. Six-inch on-center piping runs are often installed 12 to 18 inches from the exterior wall to improve response time (see **Figure 6-3**).

Counter flow —

Use this pattern when the heat loss for the room is evenly distributed throughout the entire room or when the major heat loss is the floor. Feed the supply along the exterior of the room, spiraling inward. Once the piping reaches the center of the room, the return spirals outward, parallel to the supply. Piping runs start 6 inches from walls or nailing surfaces. Six-inch on-center piping runs are often installed 12 to 18 inches from the exterior wall to improve response time (see **Figure 6-4**).



Insulation

Insulation is crucial for proper and efficient operation of radiant heating systems. Heat energy flows in the line of least resistance. Proper use of insulation directs the flow of heat toward the intended space. Good insulation practices also improve response time of the system.

Under-slab insulation

Under-slab insulation must be rated for use in that application. Insulation below heated concrete slabs must withstand the weight of the slab along with any additional dead or live loads. When concrete is applied over the insulation, the weight of the concrete causes the insulation to compress slightly. The amount of compression depends on the weight of the concrete, the thickness of the insulation and the compressibility of the insulation. Although compression reduces the insulating effect of the foam, it presents little structural effect because it remains relatively constant over the life of the structure.

A more important structural factor is the long-term compressive creep that occurs within the insulation. Creep should be accommodated in the ability of the slab to move relative to the plane of its surface. Foam insulation manufacturers provide specific recommendations regarding the limits of live and dead loads, compressive creep and the proper application of their products. Check with the foam insulation manufacturer for more information.

Use under-slab insulation when high water tables and/or moist soil conditions are present. If a known

moist soil condition exists, ensure an effective drainage system is installed beneath the intended radiant floor slab. After proper compaction, install a vapor barrier over the soil, and then install the high-density insulation. The drainage system is crucial to the success of the radiant floor system. Without correcting the moist soil condition beneath the slab, downward losses can exceed heat loss of the room above.

When in doubt, insulate. The situation cannot be corrected after the structure is complete. Additionally, proper insulation means better and more efficient operation for the life of the system.

Between-floor insulation

Insulation is normally considered for areas in contact with the exterior of the structure. With radiant floors, often the need arises for insulation between the heated floors to direct the flow of heat upward. The accepted rate of insulation between floors is a ratio of 5 to 1. For every value of resistance upward, install five times that resistance beneath the heating system. For example, if the total resistance value above the heating system (floor coverings, etc.) is R-2, then install at least R-10 beneath the heating system. In this situation, 3½ inch batt insulation (R-11) would be sufficient.

Vertical or edge

This area denotes the vertical edge of the slab or profile. Edge insulation keeps the heat contained within the area for which it is designed and minimizes lateral heat loss.

Construction, expansion and control joints

Construction, expansion and control joints are required for every slab application of any size. Coordination between the engineer, concrete installer and the radiant floor contractor is essential to avoid confusion and delays on the project.

Construction joints

Construction joints separate individual pours of a slab completed at different times. Because it is difficult to construct a large slab in one pour, a bulkhead is installed to contain sections of the slab until the next phase is poured. A phased approach makes it easier to move concrete equipment and reduces the chances that the piping will be damaged during installation.

To avoid the construction joint during installation, dip the piping below the slab into the subsoil or sleeve the piping with pipe insulation or plastic piping 6 inches on each side of the joint (see **Figures 6-5 and 6-6**).

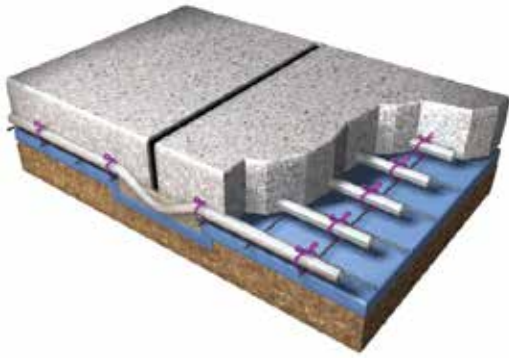

Figure 6-5: Piping dipped below construction joint

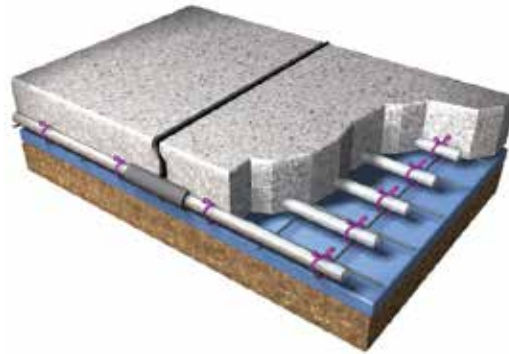

Figure 6-6: Piping wrapped with pipe insulation near construction joint

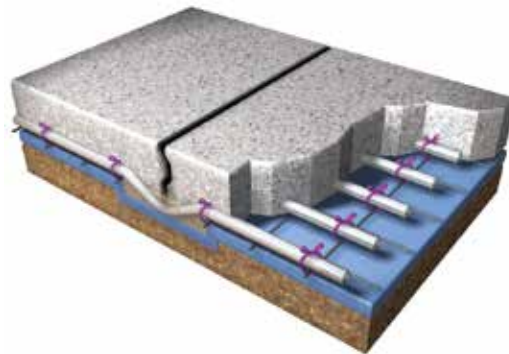

Figure 6-7: Piping dipped below expansion joint

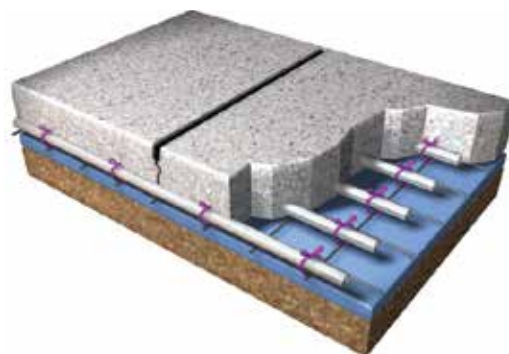

Figure 6-8: Piping secured on each side of control joint

Expansion joints

Expansion joints (also called isolation joints), absorb horizontal movement caused by the thermal expansion and contraction of the slab. Radiant floor heating systems can reduce the range of expansion the slab experiences by maintaining a fairly consistent temperature across the slab area.

If the piping must penetrate the fibrous expansion joint, wrap it with pipe insulation for 6 inches on both sides of the expansion joint (see **Figure 6-6**).

Another option is to dip the piping below the slab into the subsoil (see **Figure 6-7**). When foam insulation is used to sleeve the PEX piping running through an expansion joint and/or to accommodate minor shear action, minimum cover should be determined by the wall thickness of the insulation. For example, if the insulation used is to accommodate $\frac{3}{8}$ inch of vertical shear, select pipe insulation with a minimum wall thickness of $\frac{3}{8}$ inch.

Control joints

Control joints allow the concrete to fracture along a controlled line. There is no concern for the piping penetrating beneath a cut joint during the cracking phase of the concrete. The concern for the piping is during the phase in which the concrete is initially cut. Depending on the depth of the concrete, the control joint may penetrate from $\frac{1}{2}$ inch to depths greater than 1 inch.

Ensure that the piping is secured from the reach of the saw blade and cannot be harmed. It is recommended to secure the piping 6 inches on each side of the control joint. It is important to mark where the joint can be made after the pour (see **Figure 6-8**).

Note: When designing a radiant floor system, avoid passing the piping through or below construction, expansion and control joints whenever possible. Coordinate the placement of these joints prior to designing the piping layout.

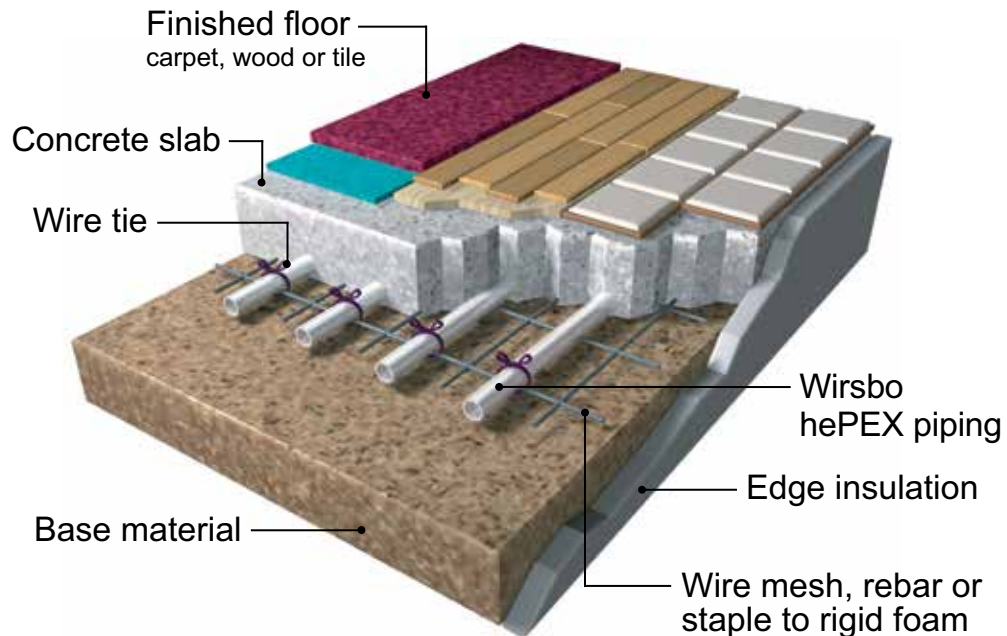

Slab on or below grade with edge insulation only

How — Place wire mesh or rebar over the compacted base material. Using Uponor Fixing Wire, secure the piping to the wire mesh or rebar. Space the wire ties a minimum of every 3 feet along straight runs. At the 180-degree turns, tie the piping at the top of the arc and once on each side, 12 inches from the top of the arc. This prevents the piping from dislodging and/or floating up into the pour.

Connect the piping to the manifold, and pressure test to a minimum of 60 psi at least overnight to ensure system integrity. Keep the piping under pressure until after the concrete is poured.

Where — This application is used primarily in commercial and light commercial construction, where room setpoint temperatures and space activities remain fairly constant. This method has several advantages including lower material costs and greater thermal storage ability. Some of the drawbacks include greater initial heat demand, longer ramp-up periods and slower response times to room setpoint changes.

What to look for — under-slab heat loss may be critical to the performance of this radiant slab design. Complete under-slab insulation is required when:

- High water table or moist soil conditions are present
- Bedrock or ledge is present
- The upper envelope heat load is greater than 25 BTU/h
- Floor covering R-value is greater than 2.0
- The linear feet of perimeter is high in comparison to the gross floor area, as in most residential applications

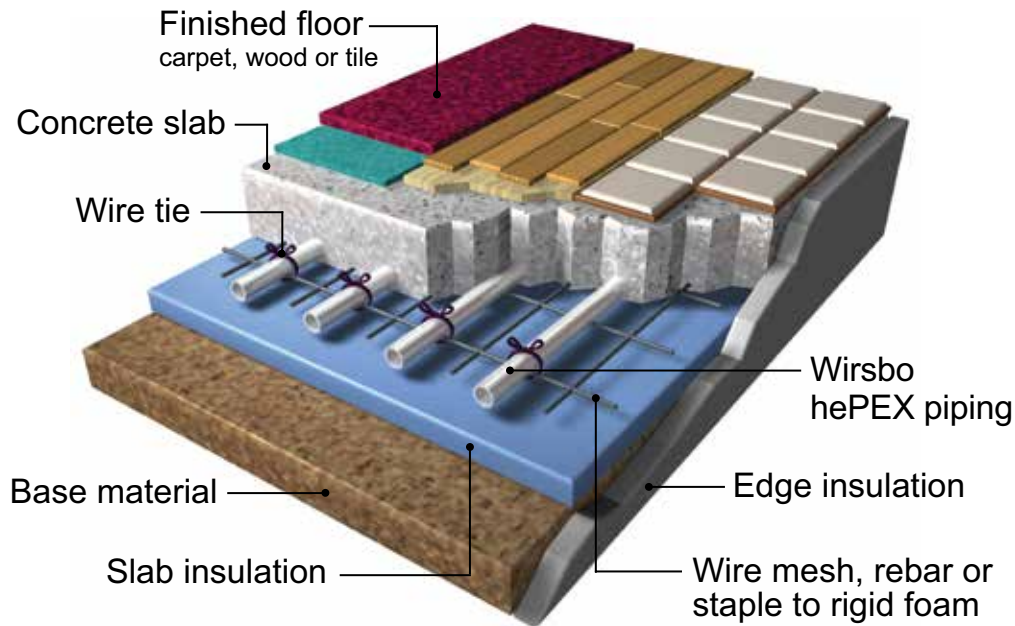

Slab on or below grade with under-slab and edge insulation

How — Place suitable, high-density rigid foam insulation over the compacted base material. Using Uponor Foam Staples with the Uponor Manual Stapler, secure the piping to the high-density insulation. Place the staples a minimum of every 3 feet along the straight runs. At the 180-degree turns, staple the piping at the top of the arc and once on each side, 12 inches from the top of the arc. This prevents the piping from dislodging and/or floating up into the pour.

Connect the piping to the manifold, and pressure test to a minimum of 60 psi at least overnight to ensure system integrity. Keep the piping under pressure until after the concrete is poured.

Where — This method is primarily used in residential slab on or below grade installations or where downward losses are great. Some of the advantages of this method include quicker response time, lower initial heat load and lower operational costs through the life of the system. The primary drawback is higher costs up front for the initial materials due to the high-density insulation.

What to look for — Under-slab heat loss may be critical to the performance of this radiant slab design. A minimum of 1 inch of insulation is used. When one or more of the items listed below are involved with the application, a minimum of 2 inches of insulation is required.

- High water table or moist soil conditions are present
- Bedrock or ledge is present
- The upper envelope heat load is high
- High R-value floor coverings are used
- The linear feet of perimeter is high in relationship to the gross floor area, as in most residential applications

Note: The wire mesh or rebar is used only as a grid system to secure the piping. Mesh or rebar has no reinforcing value when installed at the bottom of the concrete slab.

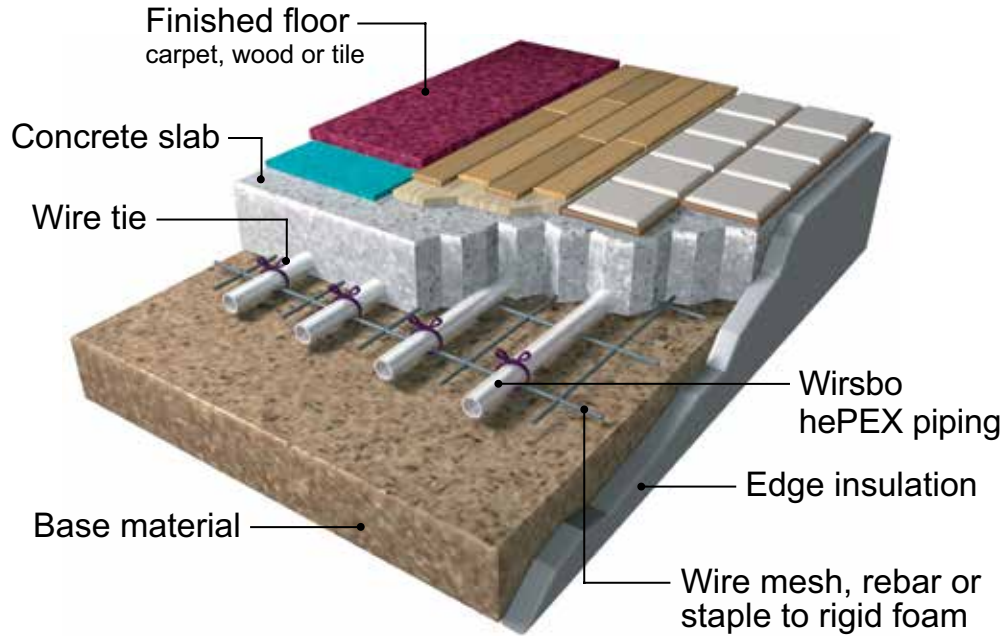

Slab on or below grade over a compacted soil/sand bed

How — Place the wire mesh or rebar over the compacted base material. Using Uponor Fixing Wire, secure the piping to the wire mesh or rebar. Place the wire ties a minimum of every 3 feet along straight runs. At the 180-degree turns, tie the piping at the top of the arc and once on each side, 12 inches from the top of the arc. This prevents the piping from dislodging and/or floating up into the pour.

Connect the piping to the manifold, and pressure test to a minimum of 60 psi at least overnight to ensure system integrity. Keep the piping under pressure until after the concrete is poured.

Lay and level a 2-inch layer of medium-grade, compacted soil/sand fill over the piping. Ensure the fill over the piping does not contain sharp aggregate. Pour concrete over the soil/sand bed.

Where — This method is used primarily in commercial and industrial applications. The purpose of the soil/sand bed is to protect the piping in case the structural slab is drilled. The advantage of this method is that the piping is unlikely to be damaged due to drilling for anchoring equipment or machinery. The disadvantages include greater material and labor costs. The slower response time due to the greater mass will have little effect within the commercial or industrial workspace.

What to look for — Under-slab heat loss may be critical to the performance of this radiant slab design. Complete under-slab insulation is recommended and essential when:

- High water table or moist soil conditions are present
- Bedrock or ledge is present
- The upper envelope heat load is high
- High R-value floor coverings are used
- The linear feet of perimeter is high in relationship to the gross floor area, as in most residential applications

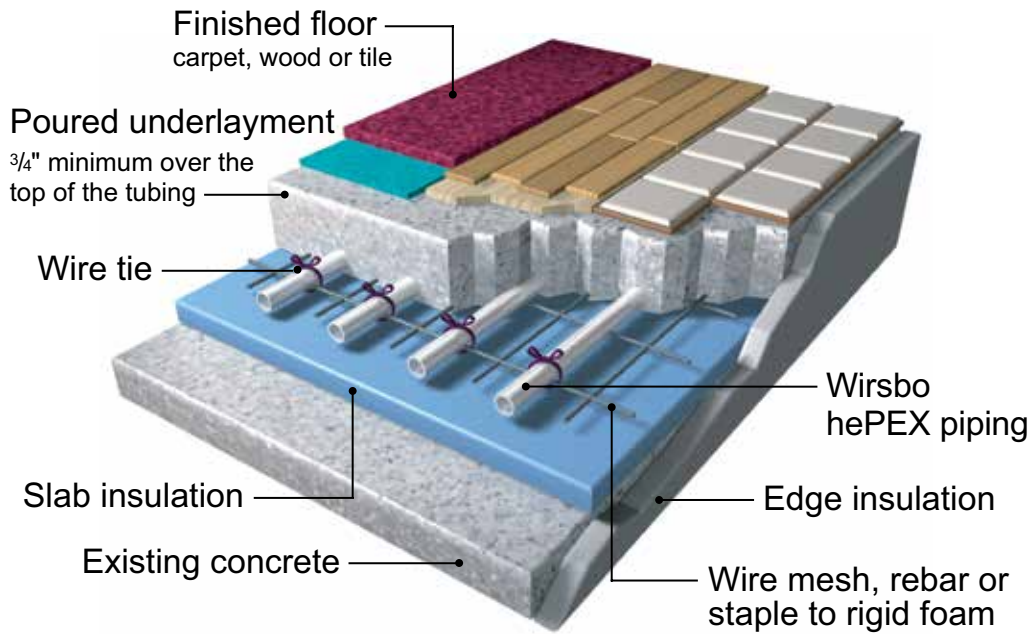

Cap pour over existing slab with under-slab insulation

How — Secure high-density insulation (minimum thickness of 1 inch) to the lower concrete slab by suitable construction adhesive and concrete screws fitted with fender washers. Secure non-structural flat wire mesh to the insulation. Using Uponor Fixing Wire, secure the piping to the wire mesh. Place the wire ties a minimum of every 3 feet along straight runs. At the 180-degree turns, tie the piping at the top of the arc and once on each side, 6 inches from the top of the arc. This prevents the piping from dislodging and/or floating up into the pour.

Connect the piping to the manifold, and pressure test to a minimum of 60 psi at least overnight to ensure system integrity. Keep the piping under pressure until after the concrete is poured.

An alternate installation method uses the Uponor Manual Stapler designed for foam insulation applications and omits the non-structural wire mesh. Using 1½" Plastic Foam Staples, secure the piping to the insulation. Staple the piping every 2 feet. At the 180-degree turns, secure two staples 6 inches below the top of the arc and two more staples on each side of the arc.

Where — This installation method is used in both commercial and residential applications. Commercially, this method is used in retrofit situations over existing concrete slabs or in new construction when piping is laid over pre-stressed concrete panels. Residentially, this method is used in retrofit situations over an existing slab, such as finishing an existing basement.

What to look for — In this type of application, the minimum pour thickness must be at least 1½ inches. The depth of the pour over the top of the piping must be at least ¾ inch. This will prevent cracking and promote good lateral and vertical heat transfer. Consult applicator for further details.

Note: The project engineer must determine the vertical compressive strength of the high-density insulation. Consult the insulation manufacturer for further information.

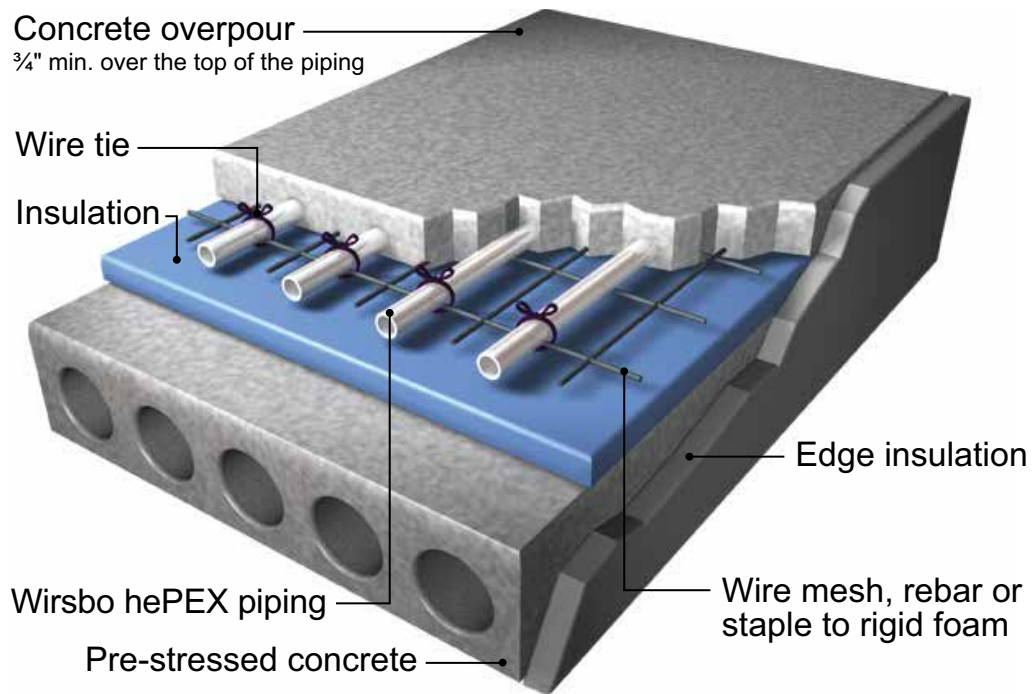

Cap pour over precast plank

How — Secure high-density insulation (minimum thickness of 1 inch) to the precast concrete plank with suitable construction adhesive and concrete screws fitted with fender washers. Secure nonstructural flat wire mesh to the insulation. Using Uponor Fixing Wire, secure the piping to the wire mesh. Place the wire ties a minimum of every 3 feet along straight runs. At the 180-degree turns, tie the piping at the top of the arc and once on each side, 6 inches from the top of the arc. This prevents the piping from dislodging and/or floating up into the pour.

Connect the piping to the manifold, and pressure test to a minimum of 60 psi at least overnight to ensure system integrity. Keep the piping under pressure until after the concrete is poured.

Where — Use this installation method primarily in commercial applications. This method may be used in retrofit situations or new construction.

What to look for — Ensure the minimum pour thickness is at least 1½ inches and the depth of the cap pour over the top of the piping is at least ¾ inch. The project engineer must determine the depth of the cap pour.

Note: The project engineer must determine the vertical compressive strength of the high-density insulation. Consult the insulation manufacturer for further information. The resistance value of the high-density insulation is determined by the radiant floor design.

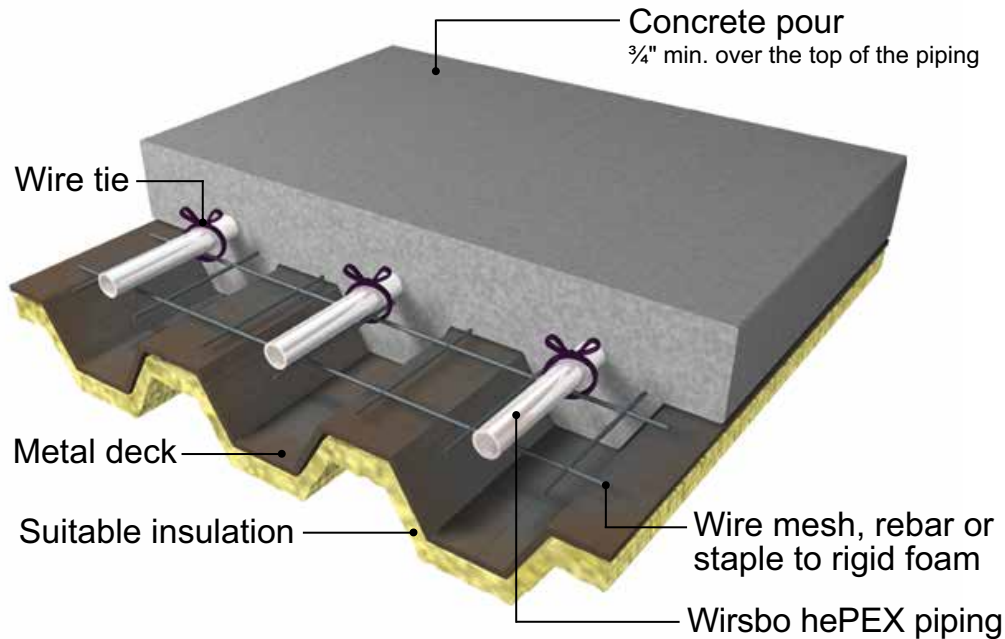

Poured-in-place slab over steel decking

How — Place wire mesh or rebar over the steel deck. In some situations, secure the piping to rebar that is chaired above the deck. Using Uponor Fixing Wire, secure the piping to the wire mesh or rebar. Place wire ties a minimum of every 3 feet along straight runs. At the 180-degree turns, tie the piping at the top of the arc and once on each side, 12 inches from the top of the arc. This prevents the piping from dislodging and/or floating up into the pour.

Connect the piping to the manifold, and pressure test to a minimum of 60 psi at least overnight to ensure system integrity. Keep the piping under pressure until after the concrete is poured.

Pour concrete over the piping and decking. The illustration above shows spray-on insulation installed beneath the decking. The radiant floor heating design determines the amount of insulation that is required for proper operation.

Where — Use this method primarily in commercial and industrial applications. With this method, the piping is installed within the concrete pour, eliminating the need for a second or cap pour.

What to look for — Under-slab heat loss may be crucial to the performance of this radiant slab design. Complete under-slab insulation is recommended and essential when:

- The upper envelope heat load is high
- High R-value floor coverings are used
- The linear feet of perimeter is high in relationship to the gross floor area
- Ambient temperature below the decking is unconditioned

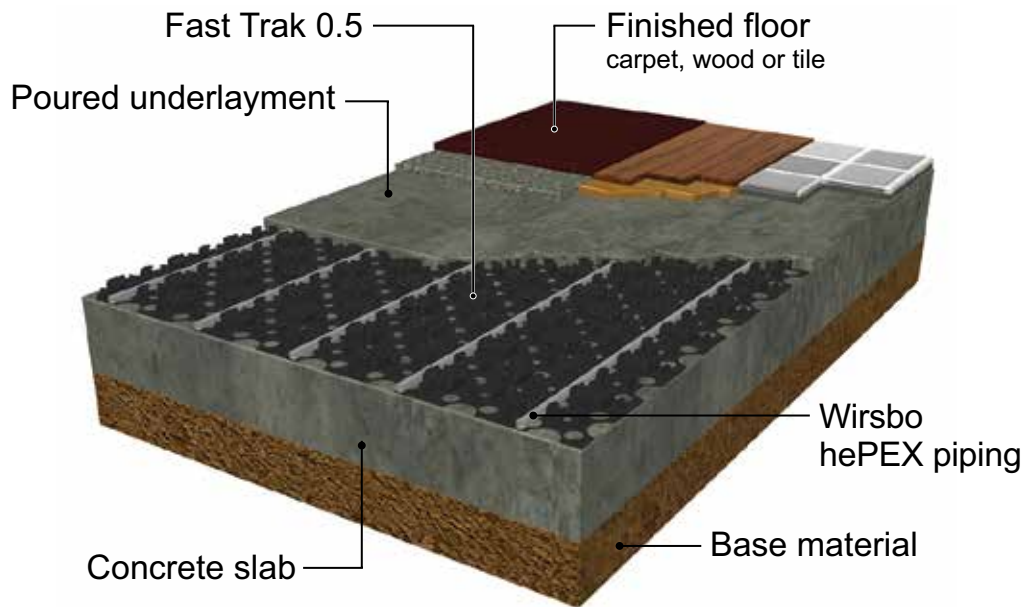

Fast Trak 0.5

How — Make sure that the subsurface is free from dust and debris before laying out the panels. Attach Fast Trak Edge Strips to the wall; be sure to cover all walls that will be exposed to the overpour. Remove the plastic foil to expose the adhesive backing before placing the panels on the floor.

Keep a 2-inch spacing to the wall when laying down the panels. Install the piping by walking or stepping the piping into the knobs on the panel. Piping spacing can be as little as 2 inches, but the turns must have a minimum radius of 3 inches.

Connect the piping to the manifold and pressure test to a minimum of 60 psi at least overnight to ensure system integrity. Keep the piping under pressure until after the overpour is poured. The overpour may be as thin as ¼ inch above the piping and still promote lateral heat transfer; however, local code may require thicker pours due to structural requirements and to avoid cracking.

Where — Uponor Fast Trak is the ideal overpour installation method for remodel and retrofit applications. The preformed, knobbed panels make it easy to install ½" Wirsbo hePEX piping for radiant floor heating systems. The Fast Trak 0.5 system requires a structural subsurface of some kind.

What to look for — A structural subsurface is required for this system, and the added weight of the overpour must be considered when determining if the finished installation can be supported by the structure.

Always check the local code for overpours to verify the pour thickness required.

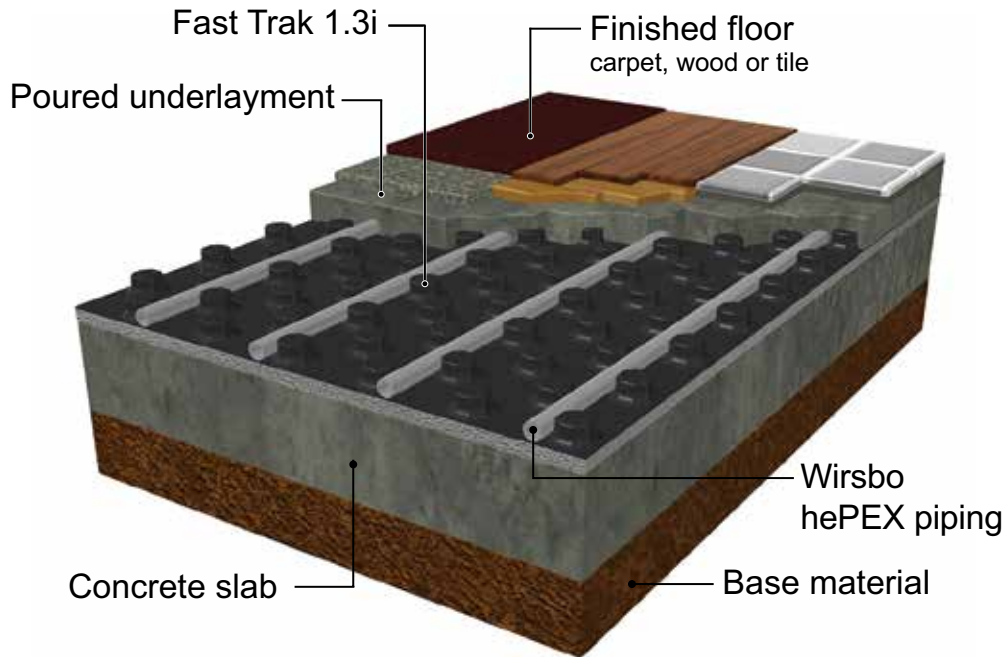

Fast Trak 1.3i

How — Make sure that the subsurface is level (see installation manual for details). If necessary, the subsurface can be leveled by using a self-leveling primer.

Ensure that the subsurface is free from dust and debris. Attach Fast Trak Edge Strips to the wall; be sure to cover all walls that will be exposed to the overpour.

Place the panels on the floor. The panels have an interlocking feature that ensures the overpour will not seep under the panels. After panels are laid out, apply the polyethylene self-adhesive strip of the Edge Strip to the Fast Trak panels to ensure the overpour cannot seep under the edges of the panel surface.

Install the piping by walking or stepping the piping into the knobs on the panel. Piping spacing can be as little as 2 inches. Turns must have a minimum radius of 3 inches for $\frac{3}{8}$ " piping and $3\frac{1}{2}$ inches for $\frac{1}{2}$ " piping.

Connect the piping to the manifold and pressure test to a minimum of 60 psi at least overnight to ensure system integrity. Keep the piping under pressure until after the overpour is poured.

Where — Uponor Fast Trak is the ideal overpour installation method for remodel and retrofit applications. The preformed, knobbed panels make it easy to install $\frac{3}{8}$ " or $\frac{1}{2}$ " Wirsbo hePEX piping for radiant floor heating systems.

What to look for — In this type of application, the pour must be at least $1\frac{1}{2}$ inches. The depth of the pour over the top of the piping must be at least $\frac{3}{4}$ inch. This will prevent cracking and promote good lateral and vertical heat transfer. Consult applicator for further details.

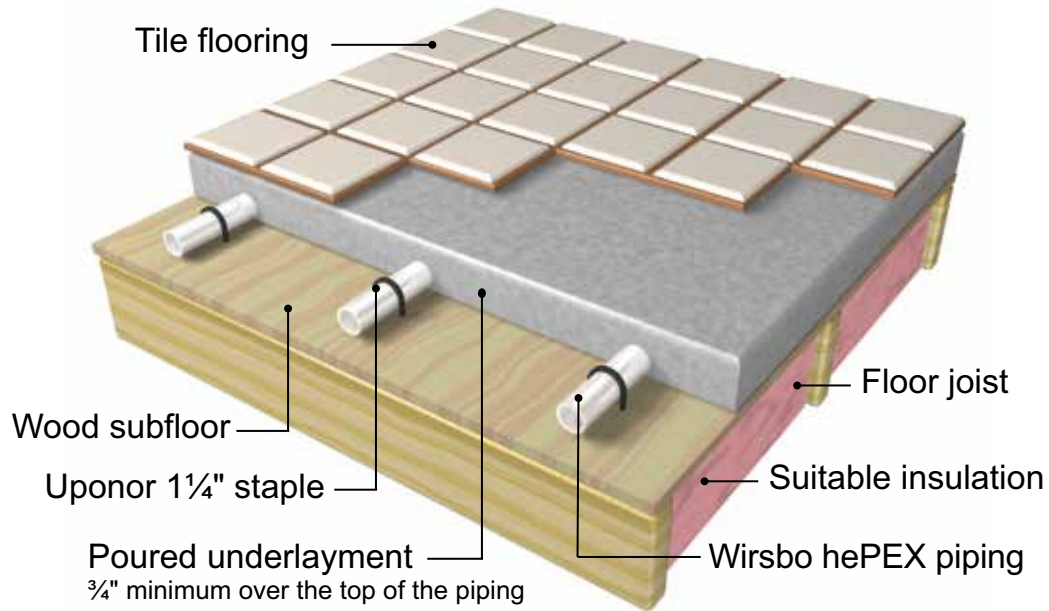

Poured underlayment on a suspended wood subfloor

How — Staple Uponor PEX directly to the subfloor using the Uponor Pneumatic Stapler. Staple the piping every 2 to 3 feet on the straight runs to prevent it from floating during the pour. At the 180-degree turns, secure one staple at the top of the arc and one staple on each side, 12 inches below the top of the arc.

Connect the piping to the manifold, and pressure test to a minimum of 60 psi at least overnight to ensure system integrity. Keep the piping under pressure until after the underlayment is poured.

Install suitable batt insulation tightly against the subfloor between the floor joists.

Where — This common residential and light commercial installation method is used when the piping is installed in a poured-floor underlayment. Pours are typically 1½ inches thick and are used as an underlayment for a hardwood, tile or carpeted finished floor.

What to look for — Take special care when installing hardwood flooring over radiant slabs. Please consult **Chapter 16** for detailed wood floor information.

The minimum depth for a concrete pour in this application should be at least ¾ inch over the top of the piping. Consult the underlayment applicator for recommended pour depths.

If a lightweight, non-gypsum based concrete is used instead of the underlayment, take care to install proper expansion joints around the perimeter of the room and on all framed walls. Additionally, use suitable wire or plastic mesh in the lightweight concrete to add structural strength to the pour. Consult the lightweight concrete installer for installation recommendations.

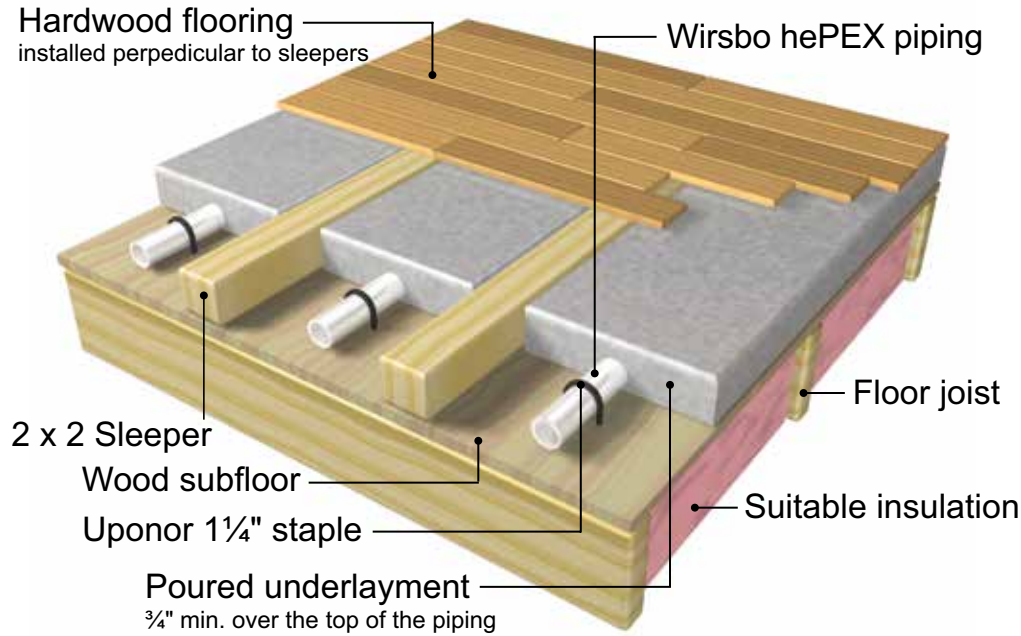

Poured underlayment with sleepers over a suspended wood subfloor

How — Staple Uponor PEX piping directly to the subfloor using the Uponor Pneumatic Stapler. Staple the piping every 2 to 3 feet on the straight runs to prevent it from floating during the pour. At the 180-degree turns, secure one staple at the top of the arc and one staple on each side, 12 inches below the top of the arc.

Install 2x2 (actual dimensions are 1½" by 1½") wood sleepers between the runs of piping, 9 to 12 inches on center. These sleepers serve as a nailing surface for hardwood floors or carpet tack strips. Install additional sleepers around the perimeter of the room.

Connect the piping to the manifold, and pressure test to a minimum of 60 psi at least overnight to ensure system integrity. Keep the piping under pressure until after the underlayment is poured.

The poured underlayment floats to the top of the sleepers resulting in a smooth, finished pour. Install suitable batt insulation tightly against the subfloor between the floor joists.

Where — This common residential and light commercial installation method is used when the piping is installed in a poured-floor underlayment. Pours are typically 1½ inches thick and are used as an underlayment for a hardwood, tile or carpeted finished floor.

Note: Uponor recommends floor surface temperatures not exceed 80°F unless the wood flooring manufacturer provides a higher temperature rating.

What to look for — Take special care when installing hardwood flooring over radiant floors. Please consult **Chapter 16** for detailed wood floor information.

The minimum depth for a concrete pour in this application should be at least ¾ inch over the top of the piping. Consult the underlayment applicator for recommended pour depths.

If a lightweight, non-gypsum based concrete is used instead of the underlayment, take care to install proper expansion joints around the perimeter of the room and on all framed walls. Additionally, use suitable wire or plastic mesh in the lightweight concrete to add structural strength to the pour. Consult the lightweight concrete installer for installation recommendations.

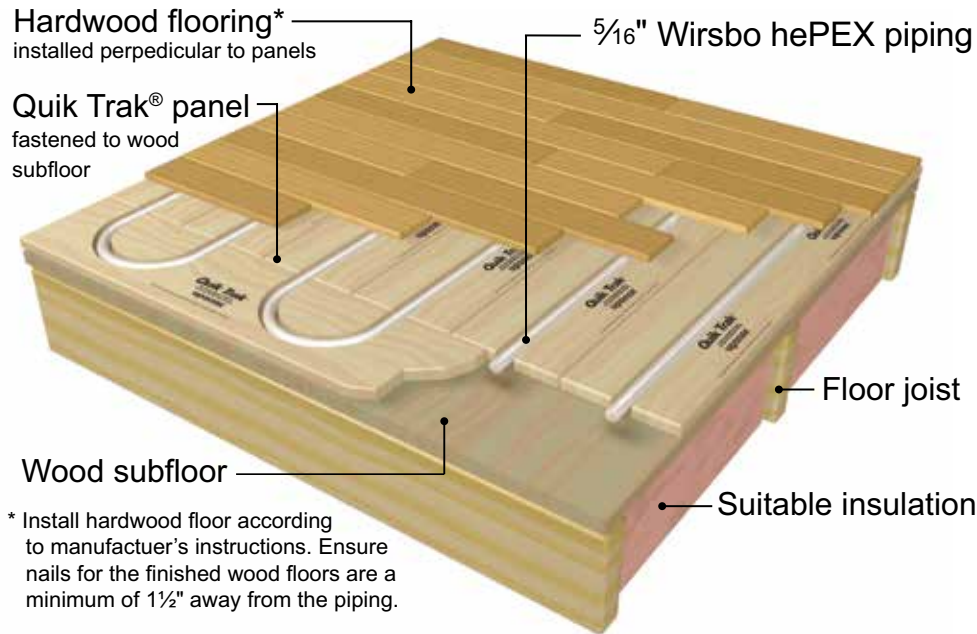

Quik Trak over a wood subfloor with hardwood floor covering

How — Lay Quik Trak panels over a plywood subfloor perpendicular to the finished wood floor. Make sure to stagger the seams of the Quik Trak.

After laying the panels, vacuum the debris from the panel grooves. Next, apply a thin (1/8-inch) bead of Uponor Quik Trak Sealant throughout the entire length of the groove. The sealant is 100% silicone. It acts as an adhesive agent and promotes good heat transfer from the piping to the panel.

Install the piping by walking or stepping the piping into the panel grooves. If you're not wearing hard-sole shoes, you may need to use a rubber hammer to snap the piping into the groove.

Secure panels to the subfloor with 1¼" Quik Trak Screws or 1" staples. To start, secure the middle of the panel with a screw or staple. Work from the middle to the ends, alternating from side to side.

Where — This application is used in residential construction as an alternative to joist heating and poured-floor underlayment installations. Quik Trak is also beneficial when the finished floor material is hardwood. Installers can actually see the piping when installing the hardwood floor. This method offers several advantages, including minimal increase in floor height, no moisture from concrete and increased BTU/h/ft² output potential over joist heating.

What to look for — Take special care when installing hardwood flooring over radiant floors. Please consult **Chapter 16** for detailed wood floor information.

Always install hardwood floors in accordance with the flooring manufacturer's instructions. Ensure nails for the finished wood floor are a minimum of 1½ inches away from the piping.

Note: Uponor recommends floor surface temperatures not exceed 80°F unless the wood flooring manufacturer provides a higher temperature rating.

Proper insulation is critical to the performance of Quik Trak. A minimum of R-19 is recommended in between the floor joists beneath the floor.

In all Quik Trak applications, the maximum loop length for 5/16" Wirsbo hePEX piping is 250 feet, including leader lengths. Flow rates for all Quik Trak installations are calculated to a 20°F temperature differential.

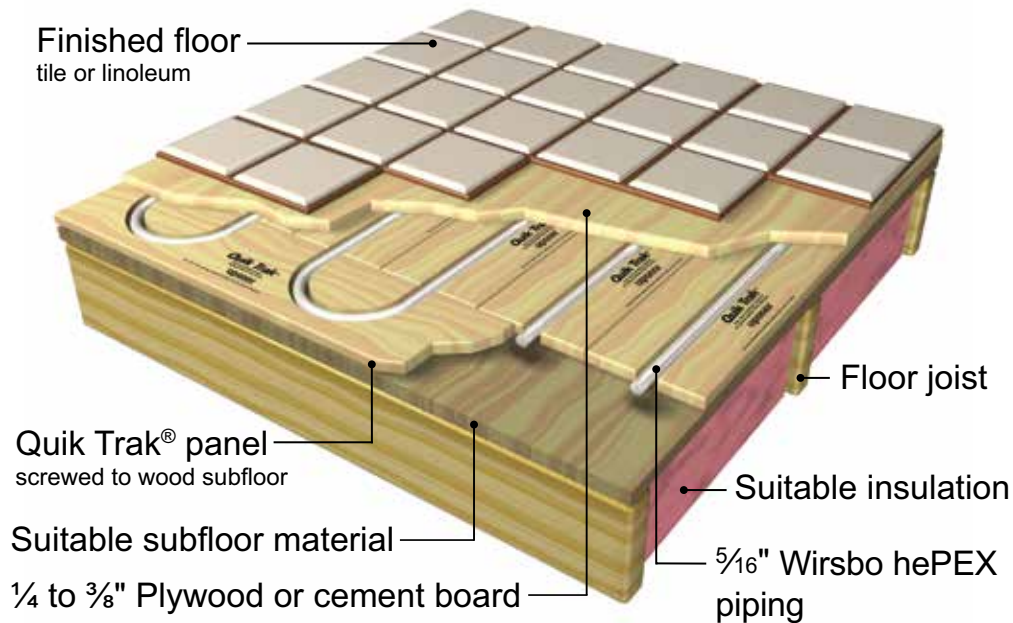

Quik Trak over a wood subfloor with tile/linoleum floor covering

How — Lay Quik Trak panels over a plywood subfloor perpendicular to the floor joists. Make sure to stagger the seams of the Quik Trak.

After laying the panels, vacuum the debris from the panel grooves. Next, apply a thin ($\frac{1}{8}$ -inch) bead of Uponor Quik Trak Sealant throughout the entire length of the groove. The sealant is 100% silicone. It acts as an adhesive agent and promotes good heat transfer from the piping to the panel.

Install the piping by walking or stepping the piping into the panel grooves. If you're not wearing hard-sole shoes, you may need to use a rubber hammer to snap the piping into the groove.

Secure panels to the subfloor with $1\frac{1}{4}$ " Quik Trak Screws or 1" staples. To start, secure the middle of the panel with a screw or staple. Work from the middle to the ends, alternating from side to side.

Where — This application is used in residential construction as an alternative to joist heating and poured-floor underlayment installations. Quik Trak is also beneficial when the finished floor material is hardwood. Installers can actually see the piping when installing the hardwood floor. This method offers several advantages, including minimal increase in floor height, no moisture from concrete and increased BTU/h/ft² output potential over joist heating.

What to look for — Proper insulation is critical to the performance of Quik Trak. A minimum of R-19 is recommended in between the floor joists beneath the floor.

Note: Do not exceed 87.5°F for tile and linoleum floor surface temperatures.

In all Quik Trak applications, the maximum loop length for $\frac{5}{16}$ " Wirsbo hePEX piping is 250 feet, including leader lengths. Flow rates for all Quik Trak installations are calculated to a 20°F temperature differential.

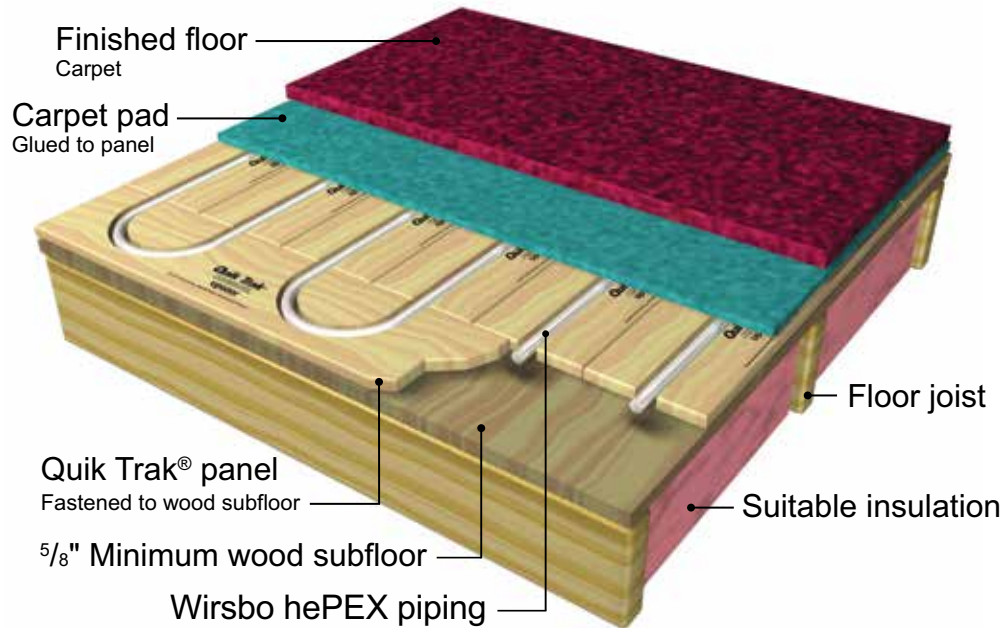

Quik Trak over a wood subfloor with carpet floor covering

How — Lay Quik Trak panels over a plywood subfloor perpendicular to the floor joists. Make sure to stagger the seams of the Quik Trak.

After laying the panels, vacuum the debris from the panel grooves. Next, apply a thin ($\frac{1}{8}$ -inch) bead of Uponor Quik Trak Sealant throughout the entire length of the groove. The sealant is 100% silicone. It acts as an adhesive agent and promotes good heat transfer from the piping to the panel.

Install the piping by walking or stepping the piping into the panel grooves. If you're not wearing hard-sole shoes, you may need to use a rubber hammer to snap the piping into the groove.

Secure panels to the subfloor with $1\frac{1}{4}$ " Quik Trak Screws or 1" staples. To start, secure the middle of the panel with a screw or staple. Work from the middle to the ends, alternating from side to side.

Where — This application is used in residential construction as an alternative to joist heating and poured-floor underlayment installations. Quik Trak is also beneficial when the finished floor material is hardwood. Installers can actually see the piping when installing the hardwood floor. This method offers several advantages, including minimal increase in floor height, no moisture from concrete and increased BTU/h/ft² output potential over joist heating.

What to look for — Proper insulation is critical to the performance of Quik Trak. A minimum of R-19 is recommended in between the floor joists beneath the floor.

Note: Do not exceed 87.5°F for carpeted floor surface temperatures.

In all Quik Trak applications, the maximum loop length for $\frac{3}{8}$ " Wirsbo hePEX piping is 250 feet, including leader lengths. Flow rates for all Quik Trak installations are calculated to a 20°F temperature differential.

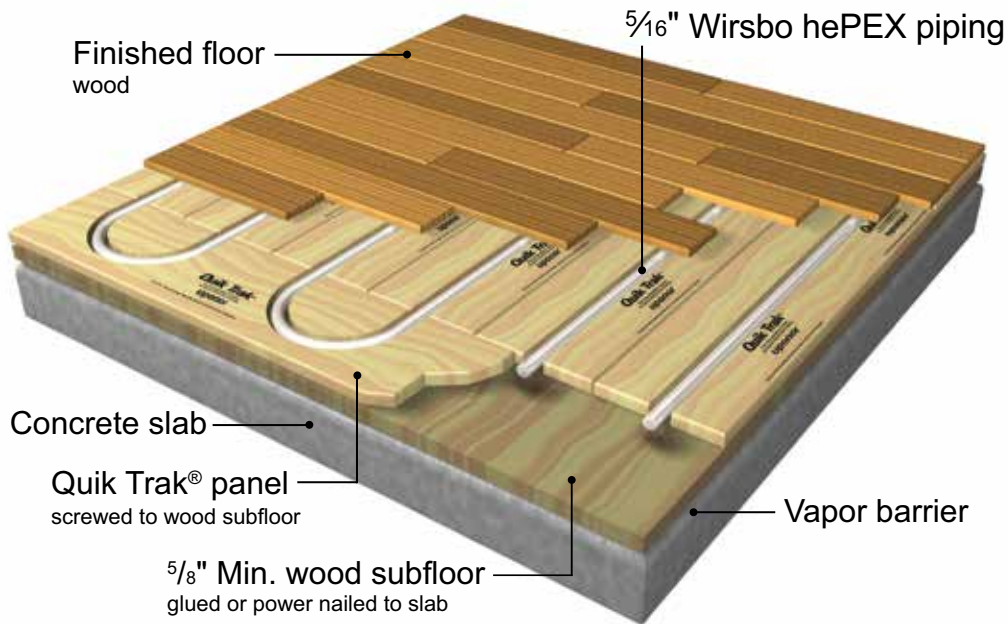

Quik Trak over an existing concrete slab

How — First, install a layer of $\frac{5}{8}$ -inch or $\frac{3}{4}$ -inch plywood subfloor over the concrete slab. Glue or power-nail the plywood directly to the concrete if a vapor barrier is not required. If a vapor barrier is required, then you must power-nail the plywood to the concrete slab.

Lay Quik Trak panels over a plywood subfloor perpendicular to the floor joists. Make sure to stagger the seams of the Quik Trak.

After laying the panels, vacuum the debris from the panel grooves. Next, apply a thin ($\frac{1}{8}$ -inch) bead of Uponor Quik Trak Sealant throughout the entire length of the groove. The sealant is 100% silicone. It acts as an adhesive agent and promotes good heat transfer from the piping to the panel.

Install the piping by walking or stepping the piping into the panel grooves. If you're not wearing hard-sole shoes, you may need to use a rubber hammer to snap the piping into the groove.

Secure the panels to the subfloor with 1" screws or 1" staples. To start, secure the middle of the panel with a screw or staple. Work from the middle to the ends, alternating from side to side.

Where — This application is used in residential construction over existing concrete slabs. The plywood base together with the Quik Trak panel only adds $1\frac{1}{8}$ to $1\frac{1}{4}$ inches in floor height. It is the ideal solution when retrofitting or remodeling a basement.

What to look for — A high water table will adversely affect the performance of this application. If there is moisture present that cannot be eliminated from the area, do not use this application.

Note: In a basement or walkout application, it is very important to install perimeter and edge insulation for proper design performance.

In all Quik Trak applications, the maximum loop length for $\frac{5}{16}$ " Wirsbo hePEX piping is 250 feet, including leader lengths. Flow rates for all Quik Trak installations are calculated to a 20°F temperature differential.

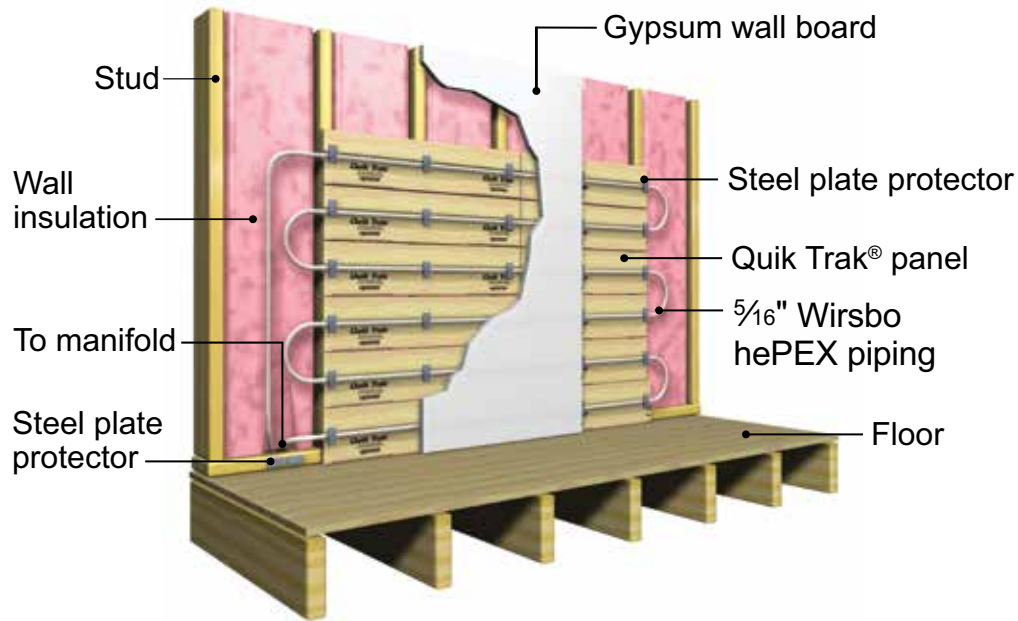

Quik Trak radiant wall installation

How — Starting at the floor level on the outside wall, install Quik Trak panels parallel to the floor at a maximum of six rows high (42 inches) to avoid interference with window and picture placement. Screw panels to the studs on both sides of the groove with 1-inch drywall screws. After the panels are installed, attach ½-inch furring strips to the remainder of the stud wall, to provide an even base for the sheetrock.

To install the piping, drill two 5/8-inch holes in the footer plate opposite the Quik Trak Return Panel. Feed the supply through the 5/8-inch hole and attach to the supply manifold. Vacuum the grooves. Apply a thin (1/8-inch) bead of Quik Trak Sealant in to the grooves. Firmly press piping into the groove. Feed return to the second 5/8-inch hole and attach to the return manifold. Lastly, attach protector plates (strike plates) where the piping crosses the studs to protect the piping from puncture.

Where — Radiant wall installations are a low-cost alternative to radiant floor heating and are often installed when radiant floor is not viable. This method is routinely used in retrofit applications. In addition, radiant wall installations are most often used in supplemental heat situations when the radiant floor cannot satisfy the heat loss of a room under design conditions.

What to look for — Do not install piping in an area where pictures may be hung.

Ensure the supply loop feeds from the top of the panel and works its way to the bottom. This will help eliminate the possibility of air lock in the loop.

Install a minimum of R-19 insulation in the exterior wall behind the Quik Trak panels.

In all Quik Trak applications, the maximum loop length for 5/8" Wirsbo hePEX piping is 250 feet, including leader lengths. Flow rates for all Quik Trak installations are calculated to a 20°F temperature differential.

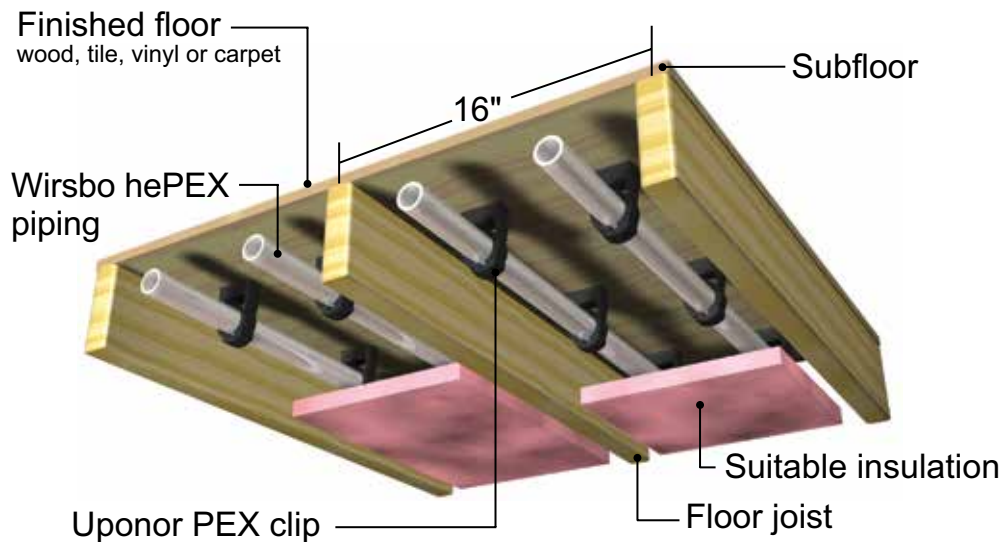

Joist heating using PEX clips

How — Drill two holes (1¼-inches minimum) side by side at the end of each joist cavity. Thread Uponor PEX piping in between the floor joists from below, looping from one joist cavity to the next as necessary. After installing piping in the last joist bay, run the PEX straight back through the joist holes behind the first set of holes. Return this end of the PEX to the manifold and connect.

Next, fasten Uponor PEX Clips to the bottom of the subfloor in each joist bay. The clips are 8 inches on center in 16-inch joist bays, 6 inches on center in 12-inch joist bays and 3 feet apart. Attach the PEX Clips with screws no larger than ¾ inch.

Install the loop farthest from the manifold by pulling the loop the length of that bay. Borrow slack from the loop hanging from the next joist bay. Snap the piping into the PEX Clips, which suspends the piping about an inch below the subfloor. Continue the process until all loops are neatly installed in the joist bays.

Install suitable insulation in the bay, an inch below the piping, leaving about a 2-inch to 3-inch air gap under the subfloor. Connect the piping to the manifold, and pressure test to a minimum of 60 psi at least overnight to ensure system integrity.

Where — This method is commonly used in both new and retrofit work where poured underlayment applications are impractical. This installation is also used for floor conditioning — the warming of floors without providing heat into the space.

Note: This installation method is not recommended for open-web truss construction. Joist heating applications using only the PEX piping suspended in the plenum must have sufficient insulation R-value, and the insulation must be installed to limit air movement from the plenum. Joist heating applications with open-web truss construction should use the Joist Trak Panels as shown on **page 53** of this manual.

What to look for — A minimum R-11 fiberglass insulation is required even if the piping is installed over a heated space. A minimum R-19 is recommended when the piping is installed in a crawlspace. Standard unfaced insulation is adequate; foil-faced insulation is not necessary.

Install piping to align with the zone areas. Install insulation vertically to block the joist cavity beneath the zone wall.

Note: Check with local building codes before drilling through floor joists.

Use either ¾" or ½" PEX piping in joist heating applications. It is not recommended to exceed maximum individual loop lengths.

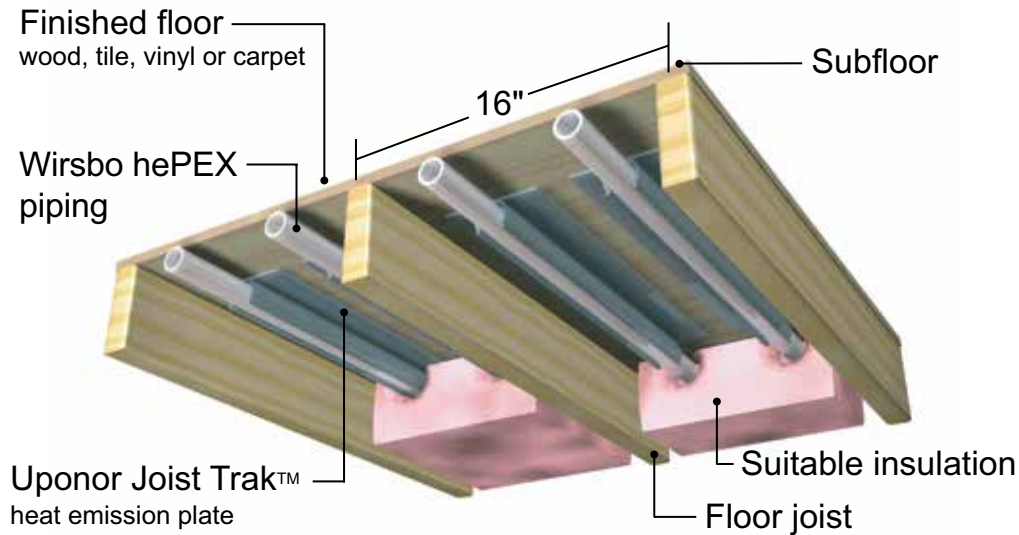

Joist heating using Joist Trak panel

How — Install the Joist Trak panels beneath the wood subfloor with ¾-inch drywall screws. In a 16-inch, on-center joist bay, install the panels equal distance between the joists. Leave about a foot at the end of the joist bay without panels to allow piping turns. Leave about an inch between panel ends.

Drill two holes (1¼-inches minimum) side by side at the end of each joist cavity. Thread PEX piping in between the floor joists from below, looping from one joist cavity to the next as necessary. After piping is installed in the last joist bay, run the PEX straight back through the joist holes behind the first set of holes. Return this end of the PEX to the manifold and connect.

Install the loop farthest from the manifold by pulling the loop the length of that bay. Borrow slack from the loop hanging from the next joist bay. Next, snap the Uponor PEX piping into the grooves of the Joist Trak panels. Continue this process until all loops are neatly installed in the joist bays.

Install suitable installation in the joist bay, snug against the panels. Connect the piping to the manifold, and pressure test to a minimum of 60 psi at least overnight to ensure system integrity.

Where — This method is commonly used in both new and retrofit work where poured underlayment applications are impractical. Installing Joist Trak panels provides the same amount of heat load support using lower supply water temperatures than joist heating without panels.

Note: Check with local building codes before drilling through floor joists.

What to look for — Allow the bends of the piping at either end of the joist bay to straighten prior to installing in the panel. This ensures the piping enters the panels in a straight line so that it does not cause noise by rubbing against the sides of the groove during operation.

A minimum R-11 fiberglass insulation is required even if the piping is installed over a heated space. A minimum R-19 is recommended when the piping is installed in a crawlspace. Standard unfaced insulation is adequate; foil-faced insulation is not necessary.

Install piping to align with the zone areas. Install insulation vertically to block the joist cavity beneath the zone wall.

Use either ¾" or ½" PEX piping in joist heating applications. It is not recommended to exceed maximum individual loop lengths.

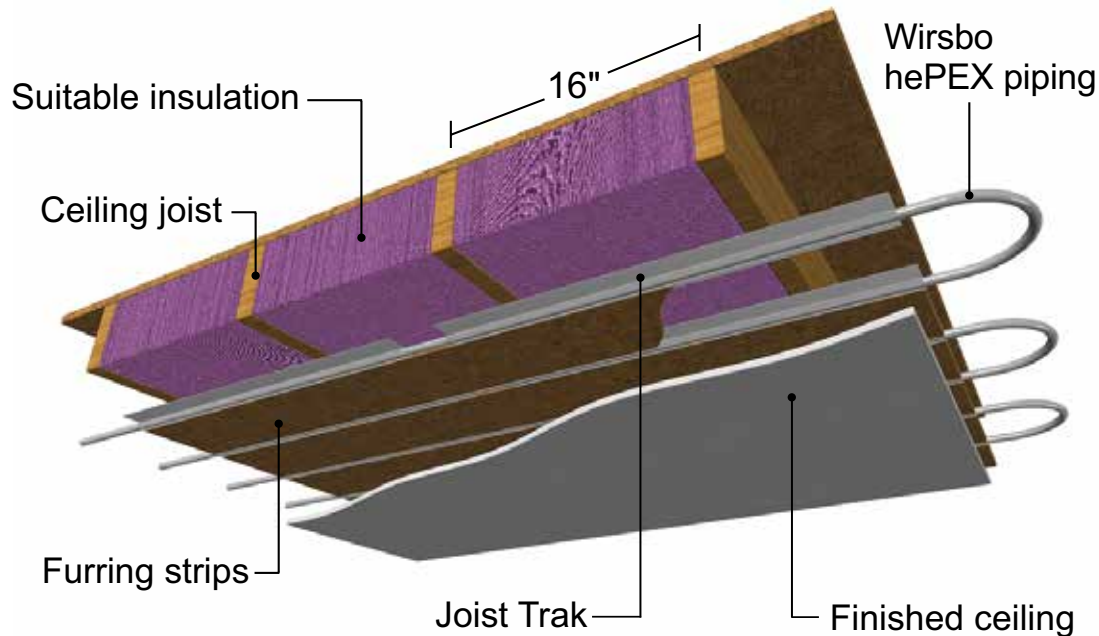

Radiant ceiling using Joist Trak panel

How — Starting at the outside wall (area of highest heat loss), secure a row of 1x6 furring strips to the bottom of the ceiling joists, perpendicular to the joists. Next, using an aluminum plate as a guide, install more rows of furring strips parallel to the first row. Staple the plates to the furring strips on one side only, allowing the plates to expand during operation. Leave about an inch gap between each plate in a row. Be sure to leave space where the wall and ceiling meet to allow for 180-degree turns in the piping. Next, following the layout pattern, snap the piping into the Joist Trak groove to complete the room.

Connect the piping to a manifold, and pressure test to a minimum of 60 psi at least overnight.

Where — Radiant ceiling is a low-cost alternative to radiant floor, and it is often installed when radiant floor is not practical or viable (e.g., common retrofit applications). Radiant ceiling is often used in bedrooms where its relative low cost and quick response time are valued. In addition, radiant ceiling is a common method of providing auxiliary or extra heat in rare situations when a radiant floor cannot satisfy the heat loss of a room under design conditions.

What to look for — While radiant ceiling can be a powerful and versatile option, it is not as comfortable as a radiant floor.

Do not exceed 120°F water temperatures with radiant ceiling. Otherwise, flash from the ceiling, streaking and hot-head/cold-feet syndrome may develop. Because of its powerful output, it is not always necessary to install radiant ceiling over the entire ceiling area.

The amount of radiant panel area installed should equal the heat load of the room. Concentrate this panel area on the outside wall where the heat loss is the greatest.

Be sure there is adequate insulation installed above the piping and plates. Insulation required by code is generally adequate, but additional insulation is required in ceilings that aren't usually insulated.

Avoid puncturing the piping while installing the sheetrock. Mark safe areas for nailing or screwing on the walls and adjacent sheetrock panels prior to installing the sheetrock.

Do not use the system to accelerate the drying time of joint compound or sprayed ceilings.

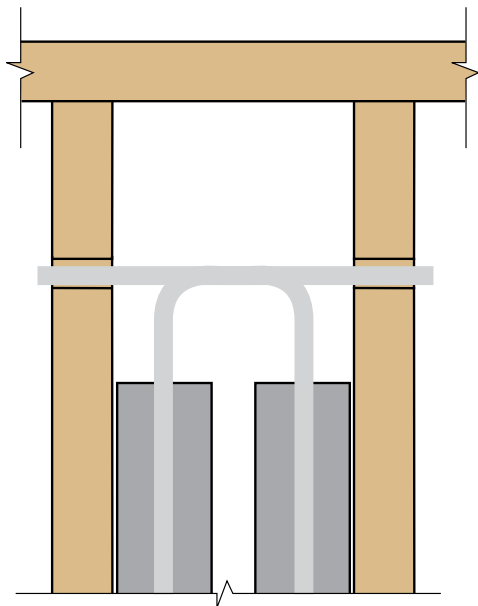

Figure 6-9: Double-run expansion loop

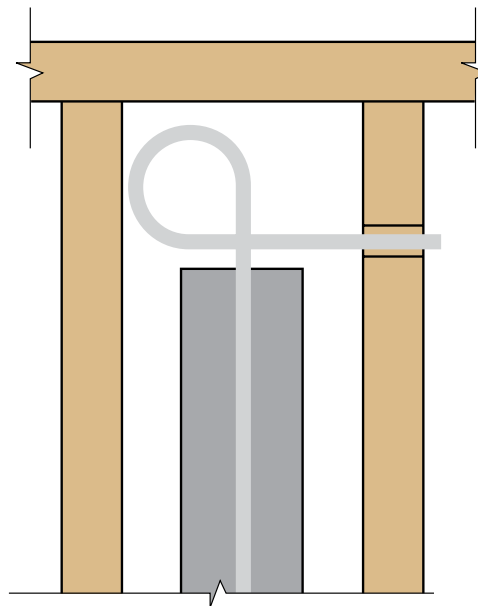

Figure 6-10: Single-plate expansion loop

Avoid expansion/contraction noise in Joist Trak installations

When using aluminum plates in radiant floor heating systems, a ticking sound can occur during operation. The sound is a result of the thermal expansion of PEX piping and the stresses placed on the aluminum plates from thermal expansion.

Uponor PEX piping products expand at a rate of 1.1 inch per 100 feet of piping per 10°F temperature rise. Aluminum plate radiant floor systems often operate around 160°F; the total temperature rise from the time of installation is around 100°F. Expansion will occur because of the significant temperature rise. If the expansion is not accommodated, some noise in the system is possible.

PEX contains a very low friction coefficient, so the piping does not make noise when it moves in the aluminum plates. The noise is caused when the piping expands and the 90-degree turns at the end of the runs move until they meet the far side of the hole drilled in the joist. If the piping continues to expand after it has hit the far end of the hole, the stress of the expansion

will transmit to the joist and back to the plate, resulting in noise.

There are several easy ways to reduce or eliminate noise.

1. Drill the holes through the joists large enough so the piping does not hit the back side of the hole when it expands. Check local building codes for information about drilling through floor joists.
2. Use open-truss span joists to avoid drilling holes in the joists.
3. Install shorter runs so more loops are available to accommodate expansion.
4. The higher the water temperature, the more the piping expands. A weather-responsive reset control will ensure the lowest required water temperature is used to provide adequate heat.
5. Install expansion loops for longer runs.

