

Uponor

UPUTE ZA MONTAŽU
MOUNTING-INSTRUCTIONS

Uponor Riser sistem MLC 63 - 110 mm

GB Uponor Riser System MLC 63 – 110 mm

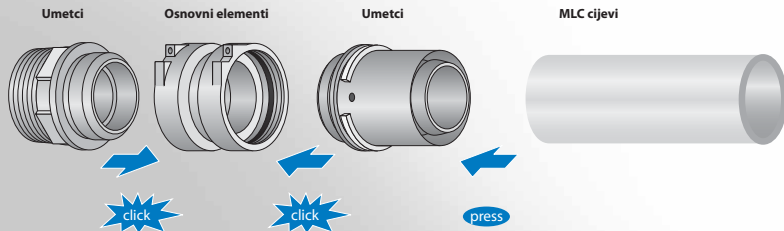

Uponor Riser sistem

Osnovni elementi RS 2

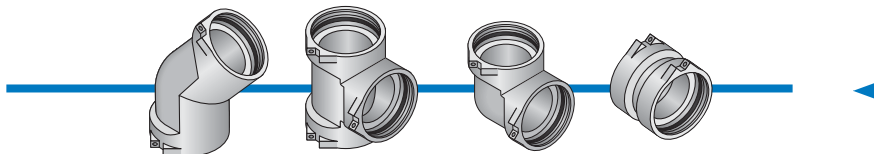

Osnovni elementi RS 3

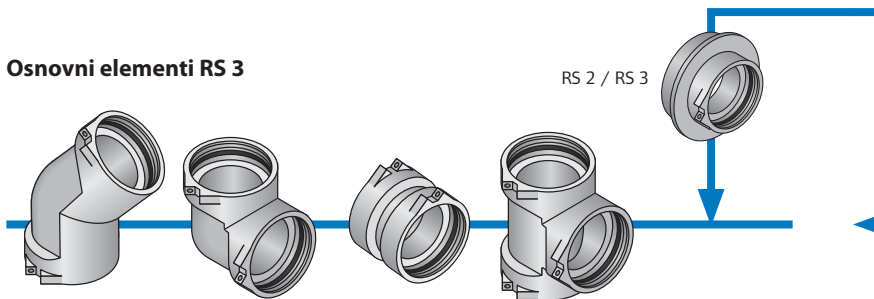

Uponor

Umetci RS 2

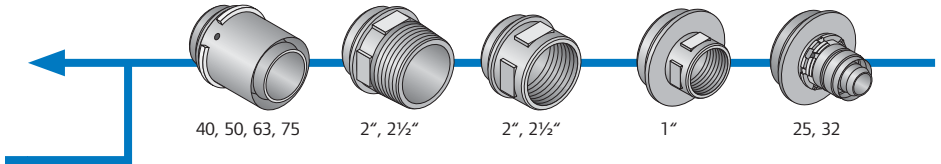

Umetci RS 3

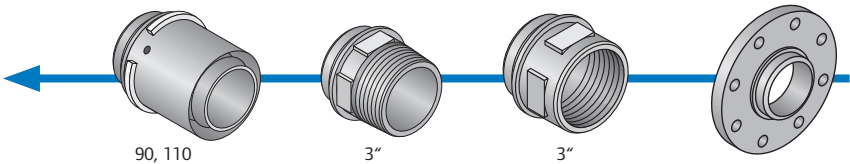

1. Rezanje · Cutting

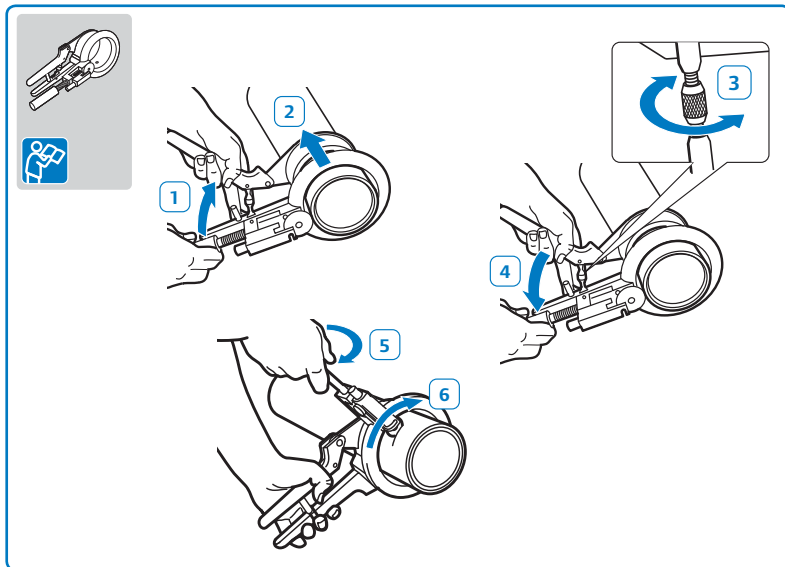

UPONOR RISER SYSTEM MLC

2. Zakošenje • Bevelling

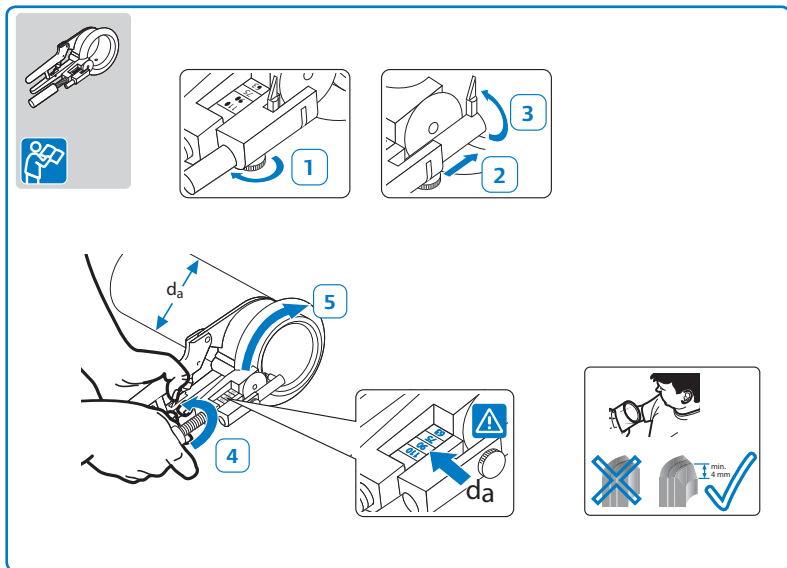

UPONOR RISER SYSTEM MLC

3. Umetnuti cijev u pres adapter i stisnuti ·

Insert pipe into press adapter and press

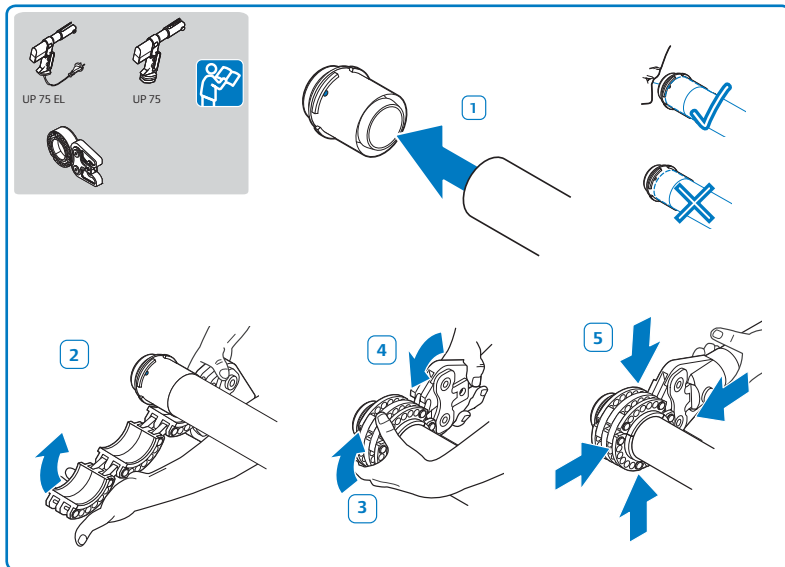

UPONOR RISER SYSTEM MLC

4. Pres adapter umetnuti u osnovni element i zavraviti sa spojnim klinom • Insert press adapter into base part and lock with lock-pin

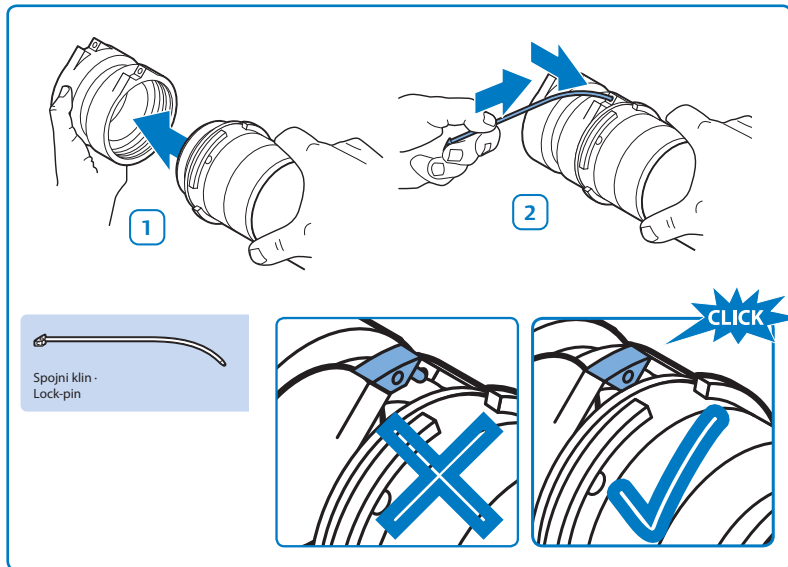

UPONOR RISER SYSTEM MLC

Uponor Riser sistem - osnovni elementi

Uponor RS spojnica/Coupling

Mesing presvučen kositrom. Osnovni element, uključivo 2 spojna klina.

Made of tin-plated brass. As RS base part, including 2 lock pins.

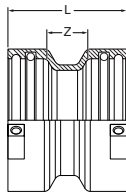

Type	Art.-No.	Z [mm]	L [mm]	St./pce. [g]
RS 2	1029144	18	51	356
RS 3	1029145	18	51	561

Uponor RS T-komad/Tee

Mesing presvučen kositrom. Osnovni element, uključivo 3 spojna klina.

Made of tin-plated brass. As RS base part, including 3 lock pins.

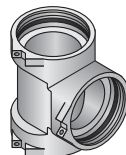
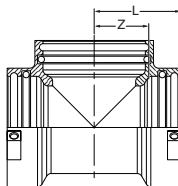

Type	Art.-No.	Z [mm]	L [mm]	St./pce. [g]
RS 2	1029142	31	51	738
RS 3	1029143	48	68	1566

UPONOR RISER SYSTEM MLC

Uponor Riser sistem - osnovni elementi

Uponor RS koljeno/Elbow 90°

Mesing presvučen kositrom. Osnovni element, uključivo 2 spojna klina.

Made of tin-plated brass. As RS base part, including 2 lock pins.

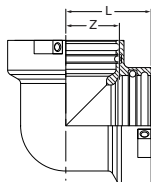

Type	Art.-No.	Z [mm]	L [mm]	St./pce. [g]
RS 2	1029138	31	51	544
RS 3	1029139	48	68	1174

Uponor RS koljeno/Elbow 45°

Mesing presvučen kositrom. Osnovni element, uključivo 2 spojna klina.

Made of tin-plated brass. As RS base part, including 2 lock pins.

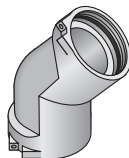
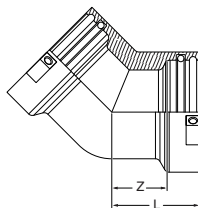

Type	Art.-No.	Z [mm]	L [mm]	St./pce. [g]
RS 2	1029140	31	51	682
RS 3	1029141	48	68	1509

UPONOR RISER SYSTEM MLC

Uponor Riser sistem - osnovni elementi

Uponor RS spojnica-redukcija/ Coupling reducer

Mesing presvučen kositrom. Osnovni element, uključivo 1 spojni klin.

Made of tin-plated brass as reducer from RS 3 to RS 2 including 1 lock pin.

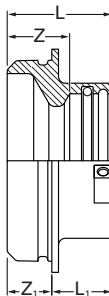

Type	Art.-No.	Z	Z1	L	L1	St./pce. [g]
RS 3 / RS 2	1029146	27	20	47	27	691

Uponor Riser sistem - umetci

Uponor RS press adapter MLC 40-110/ Press adaptor 40-110 MLC

Mesing presvučen
kositrom, stezna
čahura iz nehrđajućeg
čelika s prstenom kao
graničnikom za stezne
čeljusti pres alata.
Pristaje uz osnovne
elemente RS 2/RS 3.

Made of tin-plated
brass, press sleeve
made of stainless
steel fixed with stop
ring segment as stop
for pressing jaw. Fits
to the RS 2 / RS 3
base parts.

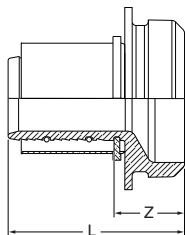
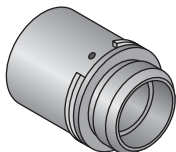

Type	Art.-No.	Z [mm]	L [mm]	St./pce. [g]
RS 2/40	1029123	27	67	386
RS 2/50	1029124	27	67	394
RS 2/63	1029125	27	91	613
RS 2/75	1029126	27	91	788
RS 3/90	1029127	31	100	1116
RS 3/110	1029128	31	100	1719

UPONOR RISER SYSTEM MLC

Uponor Riser sistem - umetci

Uponor RS press adapter MLC 25-32 Press adaptor 25-32 MLC

Mesing presvučen kositrom, stezna čahura iz nehrđajućeg čelika s prstenom kao graničnikom za stezne čeljusti pres alata. Pristaje uz osnovne elemente RS 2/RS 3.

Made of tin-plated brass, press sleeve fixed with stop ring segment as stop for pressing jaw. Fits to all RS 2 base parts.

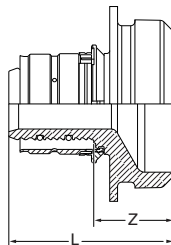
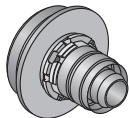

Type	Art.-No.	Z [mm]	L [mm]	St./pce. [g]
RS 2/25	1029121	29	59	350
RS 2/32	1029122	29	59	364

UPONOR RISER SYSTEM MLC

Uponor Riser sistem - umetci

Uponor RS navojni adapter ž.n. Thread adaptor FT

Mesing presvučen kositrom. Pristaje uz sve osnovne elemente RS 2/RS 3. Cilindrični ženski navoj prema DIN EN 10 226-1.

Made of tin-plated brass. Fits to all RS 2/RS 3 base parts. Cylindrical female thread acc. to DIN EN 10 226-1.

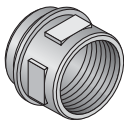
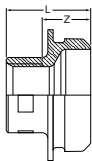

Type	Art.-No.	Z [mm]	L [mm]	St./pce. [g]
RS 2/Rp 1	1029134	26	45	329
RS 2/Rp 2	1029135	28	54	508
RS 2/Rp 2½	1029136	32	63	607
RS 3/Rp 3	1029137	32	65	827

Uponor RS navojni adapter m.n. Thread adaptor MT

Mesing presvučen kositrom. Pristaje uz sve osnovne elemente RS 2/RS 3. Cilindrični ženski navoj prema DIN EN 10 226-1.

Made of tin-plated brass. Fits to all RS 2/RS 3 base parts. Male thread acc. to DIN EN 10 226-1 for sealing in.

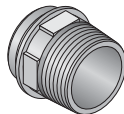
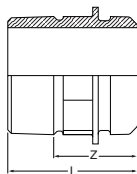

Type	Art.-No.	Z [mm]	L [mm]	St./pce. [g]
RS 2/R 2	1029131	43	66	511
RS 2/R 2½	1029132	37	64	578
RS 3/R 3	1029133	43	73	881

UPONOR RISER SYSTEM MLC

Uponor Riser sistem - umetci

Uponor RS prirubnica/Flange

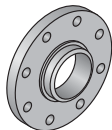

Mesing presvučen
kositrom, PN 16.
Pristaje uz sve
osnovne elemente
RS 3. Predviđeno 8
provrti za stezne vijke.

Made of tin-plated
brass, PN 16. Fits to
all RS 3 base parts.
Bolt circle with
8 holes.

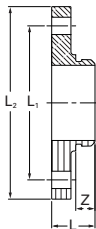

Type	Art.-No.	Z	L	L1	L2	St./ pce. [g]
RS 3/DN 80	1029129	20	45	160	200	4478
RS 3/DN 100	1029130	20	44	180	220	5223

Uponor Riser sistem - umetci

Uponor press spoj MLC 63 - 2 3/8 / Uponor Press-connection MLC 63-G2 3/8

Mesing presvučen kositrom, fiksna stezna čahura i ravna brtva.. Vijčana spojka za spoj s nazidnim fitinzima, filterima i zapornim slavinama. Navoj prema DIN EN ISO 228-1.

Made of tin-plated brass, with fixed press sleeve and flat seal. Releasable screw connector for connection to on-wall fittings, filters and shutoff valves. T thread acc. to DIN EN I SO 228-1.

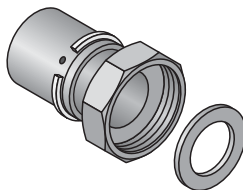
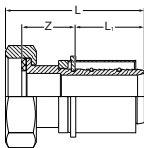

Type	Art.-No.	Z	L	L1	St./ pce. [g]
63 x G 2 3/8	1029147	36	113	64	976

UPONOR RISER SYSTEM MLC

Uponor - partnerstvo s profesionalcima

Uponor je vodeći internacionalni ponuđač sustava cjevovoda za sanitarnu vodu i grijanje stambenih i javnih objekata u Europi i Sjevernoj Americi. Osnovna djelatnost tvrtke su cijevni sustavi površinskih grijanja/hlađenja, sanitarne vode i komunalne infrastrukture.

Uponor je na tržištima Europe i Sjeverne Amerike vodeći isporučilac cjevovodnih sustava za sanitarnu vodu i grijanje stambenih i javnih objekata. Na tržištima Nordijskih zemalja tu ulogu ima u sustavima komunalne infrastrukture. Uponorova ključna djelatnost je unutarnja klimatizacija i sustavi cjevovoda. Grupa zapošljava 4 000 osoba u 27 zemalja.

Uponor International Sales se brine o poslovnim aktivnostima zemalja na Balkanu, Zapadnoj, Centralnoj i istočnoj Aziji, Africi i Latinskoj Americi.

Uponor. Simply more.

Predstavništvo u Republici Hrvatskoj

PONOR GmbH
Dubravkin trg 2/1
10 000 Zagreb
Hrvatska

T +385 1 61 97 158
F +385 1 61 97 157
E croatia@uponor.com
W www.uponor.hr

The logo for Uponor, featuring the word "uponor" in a bold, blue, lowercase sans-serif font.